



CY8CKIT-040

PSoC[®] 4000 Pioneer Kit Guide

Doc. # 001-91316 Rev. *C

Cypress Semiconductor
198 Champion Court
San Jose, CA 95134-1709
Phone (USA): 800.858.1810
Phone (Intl): +1.408.943.2600
www.cypress.com

Copyrights

© Cypress Semiconductor Corporation, 2014-2015. The information contained herein is subject to change without notice. Cypress Semiconductor Corporation assumes no responsibility for the use of any circuitry other than circuitry embodied in a Cypress product. Nor does it convey or imply any license under patent or other rights. Cypress products are not warranted nor intended to be used for medical, life support, life saving, critical control or safety applications, unless pursuant to an express written agreement with Cypress. Furthermore, Cypress does not authorize its products for use as critical components in life-support systems where a malfunction or failure may reasonably be expected to result in significant injury to the user. The inclusion of Cypress products in life-support systems application implies that the manufacturer assumes all risk of such use and in doing so indemnifies Cypress against all charges.

Any Source Code (software and/or firmware) is owned by Cypress Semiconductor Corporation (Cypress) and is protected by and subject to worldwide patent protection (United States and foreign), United States copyright laws and international treaty provisions. Cypress hereby grants to licensee a personal, non-exclusive, non-transferable license to copy, use, modify, create derivative works of, and compile the Cypress Source Code and derivative works for the sole purpose of creating custom software and or firmware in support of licensee product to be used only in conjunction with a Cypress integrated circuit as specified in the applicable agreement. Any reproduction, modification, translation, compilation, or representation of this Source Code except as specified above is prohibited without the express written permission of Cypress.

Disclaimer: CYPRESS MAKES NO WARRANTY OF ANY KIND, EXPRESS OR IMPLIED, WITH REGARD TO THIS MATERIAL, INCLUDING, BUT NOT LIMITED TO, THE IMPLIED WARRANTIES OF MERCHANTABILITY AND FITNESS FOR A PARTICULAR PURPOSE. Cypress reserves the right to make changes without further notice to the materials described herein. Cypress does not assume any liability arising out of the application or use of any product or circuit described herein. Cypress does not authorize its products for use as critical components in life-support systems where a malfunction or failure may reasonably be expected to result in significant injury to the user. The inclusion of Cypress' product in a life-support systems application implies that the manufacturer assumes all risk of such use and in doing so indemnifies Cypress against all charges.

Use may be limited by and subject to the applicable Cypress software license agreement.

PSoC and CapSense are registered trademarks and PSoC Components, PSoC Creator, and SmartSense are trademarks of Cypress Semiconductor Corporation. All other products and company names mentioned in this document may be the trademarks of their respective holders.

Purchase of I²C components from Cypress or one of its sublicensed Associated Companies conveys a license under the Philips I²C Patent Rights to use these components in an I²C system, provided that the system conforms to the I²C Standard Specification as defined by Philips. As from October 1st, 2006 Philips Semiconductors has a new trade name - NXP Semiconductors.

Flash Code Protection

Cypress products meet the specifications contained in their particular Cypress Datasheets. Cypress believes that its family of products is one of the most secure families of its kind on the market today, regardless of how they are used. There may be methods, unknown to Cypress, that can breach the code protection features. Any of these methods, to our knowledge, would be dishonest and possibly illegal. Neither Cypress nor any other semiconductor manufacturer can guarantee the security of their code. Code protection does not mean that we are guaranteeing the product as "unbreakable."

Cypress is willing to work with the customer who is concerned about the integrity of their code. Code protection is constantly evolving. We at Cypress are committed to continuously improving the code protection features of our products.

Contents



Safety Information	5
1. Introduction	7
1.1 Kit Contents	7
1.2 PSoC Creator	9
1.2.1 PSoC Creator Code Examples	10
1.2.2 Kit Code Example	11
1.2.3 PSoC Creator Help	12
1.3 Getting Started.....	13
1.4 Additional Learning Resources.....	13
1.5 Technical Support.....	14
1.6 Documentation Conventions.....	14
2. Software Installation	15
2.1 Before You Begin.....	15
2.2 Install Software	15
2.3 Install Hardware.....	17
2.4 Uninstall Software.....	18
3. Kit Operation	19
3.1 Kit Overview.....	19
3.2 Kit USB Connection	21
3.3 Programming and Debugging PSoC 4000	22
3.3.1 Using the Onboard PSoC 5LP Programmer and Debugger	22
3.3.2 Using the CY8CKIT-002 MiniProg3 Programmer and Debugger.....	23
3.4 USB-I2C Bridge	26
3.5 USB-UART Bridge	27
3.6 Updating the Onboard Programmer Firmware	28
4. Hardware	31
4.1 Board Details	31
4.2 Block Diagram	34
4.3 Kit Component Details	35
4.3.1 CY8CKIT-040 Baseboard Components	35
4.3.2 CY8CKIT-040 CapSense Trackpad Shield Board.....	49
5. Code Examples	51
5.1 Overview.....	51
5.1.1 Programming the Example Projects.....	51
5.2 Project: Blinking LED	56
5.2.1 Project Overview.....	56

5.2.2	Project Description.....	57
5.2.3	Verify Output.....	58
5.3	Project: CapSense Proximity and UART.....	59
5.3.1	Project Overview.....	59
5.3.2	Project Description.....	60
5.3.3	Verify Output.....	69
5.4	Project: CapSense Touchpad with I2C Tuner.....	76
5.4.1	Project Overview.....	76
5.4.2	Project Description.....	78
5.4.3	Verify Output.....	81
5.5	Project: Color Palette.....	86
5.5.1	Project Overview.....	86
5.5.2	Project Description.....	86
5.5.3	Verify Output.....	103
5.6	ADC in PSoC 4000.....	104
5.6.1	Using PSoC Creator Code example: ADC_VoltageInput.....	104
6.	Advanced Topics	107
6.1	Using PSoC 5LP as a USB-I2C Bridge.....	107
6.2	Using FM24W256 F-RAM.....	115
6.2.1	Address Selection.....	115
6.2.2	Write/Read Operation.....	116
6.2.3	Example Firmware.....	117
6.3	Using PSoC 5LP as a USB-UART Bridge.....	120
6.4	Developing Applications for PSoC 5LP.....	133
6.4.1	Building a Bootloadable Project for PSoC 5LP.....	134
6.4.2	Building a Normal Project for PSoC 5LP.....	142
6.5	PSoC 5LP Factory Program Restore Instructions.....	144
6.5.1	PSoC 5LP Programmed with a Bootloadable Application.....	144
6.5.2	PSoC 5LP Programmed with a Standard Application.....	150
6.6	Using μ C/Probe Tool.....	152
A.	Appendix	161
A.1	CY8CKIT-040 Schematics.....	161
A.2	Pin Assignment Table.....	166
A.3	Program and Debug Headers.....	168
A.4	Use of Zero-ohm Resistors and No Load.....	169
A.5	KitProg Status LED States.....	170
A.6	Bill of Materials.....	171
A.7	Trackpad/Touchpad Sticker Details.....	174
A.8	Regulatory Compliance Information.....	174
A.9	Migrating projects across different Pioneer series kits.....	175
	Revision History	179

Safety Information



Regulatory Compliance

The CY8CKIT-040 PSoC[®] 4000 Pioneer Kit is intended for use as a development platform for hardware or software in a laboratory environment. The board is an open system design, which does not include a shielded enclosure. For this reason, the board may cause interference to other electrical or electronic devices in close proximity. In a domestic environment, this product may cause radio interference. In such cases, the user may be required to take adequate preventive measures. Also, this board should not be used near any medical equipment or RF devices.

Attaching additional wiring to this product or modifying the product operation from the factory default may affect its performance and cause interference with other apparatus in the immediate vicinity. If such interference is detected, suitable mitigating measures should be taken.

The CY8CKIT-040 as shipped from the factory has been verified to meet with requirements of CE as a Class A product.



The CY8CKIT-040 contains electrostatic discharge (ESD) sensitive devices. Electrostatic charges readily accumulate on the human body and any equipment, and can discharge without detection. Permanent damage may occur to devices subjected to high-energy discharges. Proper ESD precautions are recommended to avoid performance degradation or loss of functionality. Store unused CY8CKIT-040 boards in the protective shipping package.



End-of-Life/Product Recycling

The end of life for this kit is five years from the date of manufacture mentioned on the back of the box. Contact your nearest recycler to discard the kit.

General Safety Instructions

ESD Protection

ESD can damage boards and associated components. Cypress recommends that the user perform procedures only at an ESD workstation. If an ESD workstation is not available, use appropriate ESD protection by wearing an antistatic wrist strap attached to the chassis ground (any unpainted metal surface) on the board when handling parts.

Handling Boards

CY8CKIT-040 boards are sensitive to ESD. Hold the board only by its edges. After removing the board from its box, place it on a grounded, static free surface. Use a conductive foam pad if available. Do not slide the board over any surface.

1. Introduction



Thank you for your interest in the PSoC[®] 4000 Pioneer Kit. The kit is designed as an easy-to-use and inexpensive development kit, highlighting the unique flexibility of the PSoC 4000 architecture. Designed for flexibility, this kit offers footprint compatibility with several third-party Arduino[™] shields. In addition, the board features an RGB LED, integrated USB programmer/debugger, a program/debug header, USB-UART/I²C bridges, a proximity header, and an Arduino-compatible CapSense[®] Trackpad shield. This kit supports either 5 V or 3.3 V as power supply voltages.

The PSoC 4000 Pioneer Kit is based on the PSoC 4000 device family, delivering a programmable platform for a wide range of embedded applications. The PSoC 4000 is the smallest member of the PSoC 4 platform with support for CapSense, Timer Counter Pulse Width Modulator (TCPWM), I²C master or slave, and up to 20 GPIOs. PSoC 4000 is a cost-optimized, entry-level PSoC 4 device targeted as socket replacements for obsolete and/or proprietary 8-bit and 16-bit MCUs. PSoC 4000 with its ARM Cortex-M0 core provides 32 programmable peripherals including CapSense.

1.1 Kit Contents

The PSoC 4000 Pioneer Kit contains the following (see [Figure 1-1](#)):

- PSoC 4000 Pioneer Kit board
- Trackpad shield board with a color palette sticker
- Quick start guide
- USB Standard A to Mini-B cable
- 6 jumper wires

Note: Trackpad and Touchpad denote the same in the context of this document and can be used interchangeably.

Figure 1-1. Kit Contents



Inspect the contents of the kit; if you find any part missing, contact your nearest Cypress sales office for help: www.cypress.com/go/support.

Download the latest version of the kit setup file from www.cypress.com/CY8CKIT-040.

1.2 PSoC Creator

PSoC Creator™ is a state-of-the-art, easy-to-use integrated design environment (IDE). It introduces revolutionary hardware and software co-design, powered by a library of preverified and precharacterized PSoC Components. With PSoC Creator, you can:

1. Drag and drop Components to build your hardware system design in the main design workspace
2. Codesign your application firmware with the PSoC hardware
3. Configure Components using configuration tools
4. Explore the library of 100+ Components
5. Review Component datasheets

Figure 1-2. PSoC Creator Features

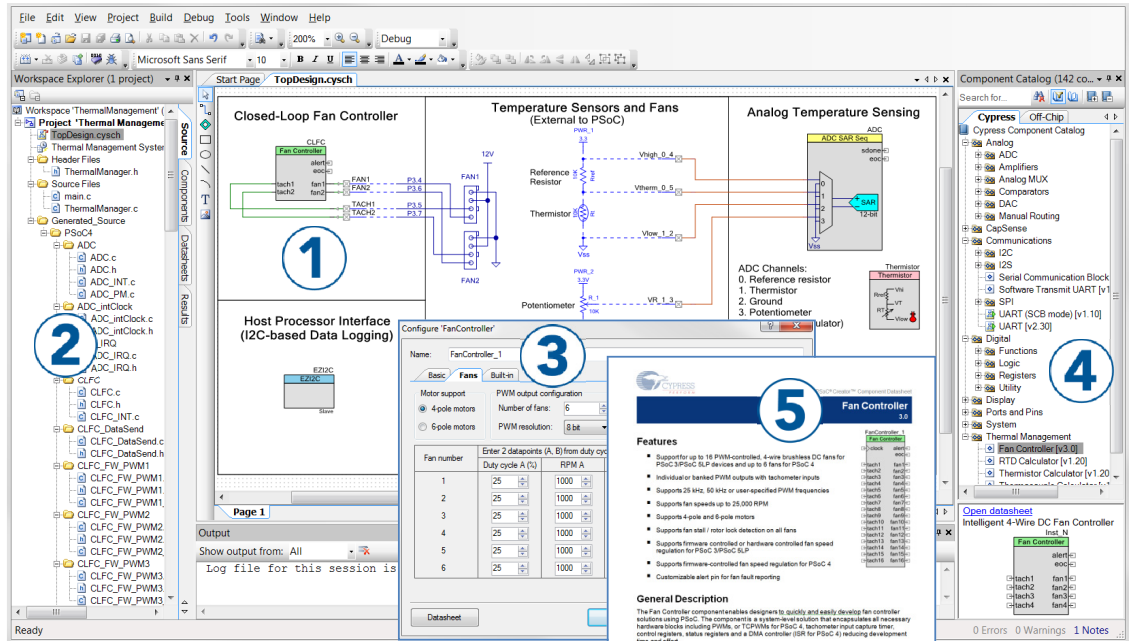

PSoC Creator also enables you to tap into an entire tool ecosystem with integrated compiler chains and production programming programmers for PSoC devices.

For more information, visit www.cypress.com/psoccreator. Visit [PSoC Creator training page](#) for video tutorials on learning and using PSoC Creator.

1.2.1 PSoC Creator Code Examples

PSoC Creator includes a large number of code examples. These examples are available from the PSoC Creator Start Page, as [Figure 1-3](#) shows.

Code examples can speed up your design process by starting you off with a complete design, instead of a blank page. The code examples also show how PSoC Creator Components can be used for various applications. Code examples and documentation are included, as shown in [Figure 1-4 on page 11](#).

In the **Find Example Project** dialog shown in [Figure 1-4 on page 11](#), you have several options:

- Filter for examples based on architecture or device family, that is, PSoC 3, PSoC 4, or PSoC 5LP; project name; or keyword.
- Select from the menu of examples offered based on the **Filter Options**.
- Review the example project's description (on the **Documentation** tab).
- Review the code from the **Sample Code** tab. You can copy the code from this window and paste to your project, which can help speed up code development.
- Create a new project (and a new workspace if needed) based on the selection. This can speed up your design process by starting you off with a complete, basic design. You can then adapt that design to your application.

Figure 1-3. Code Examples in PSoC Creator

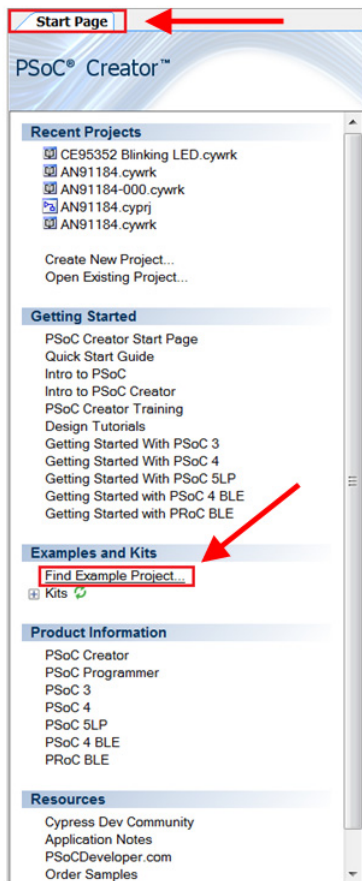
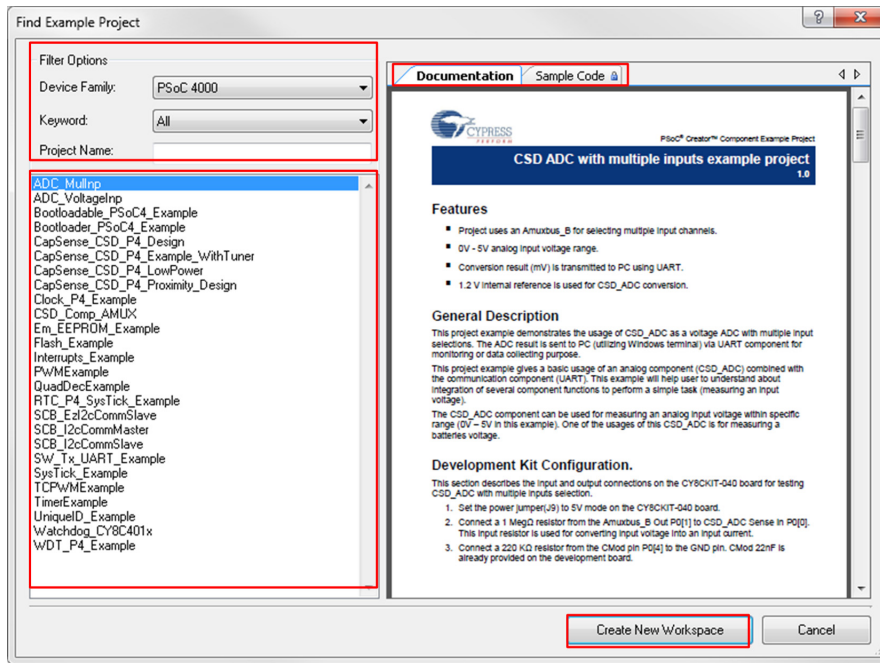

Figure 1-4. Code Example Projects with Sample Code



1.2.2 Kit Code Example

In addition to the examples built into PSoC Creator, this kit includes a simple example, which can be used to quickly evaluate the functionality of this kit. The example is described in the [Code Examples chapter on page 51](#). In addition, the chapter also includes a section explaining how to use PSoC Creator code examples with the kit by taking one example.

1.2.3 PSoC Creator Help

Visit the [PSoC Creator home page](#) to download the latest version of PSoC Creator. Then, launch PSoC Creator and navigate to the following items:

- **Quick Start Guide:** Choose **Help > Documentation > Quick Start Guide**. This guide gives you the basics for developing PSoC Creator projects.
- **Simple Component example projects:** Choose **File > Example project...**. These example projects demonstrate how to configure and use PSoC Creator Components.
- **Starter designs:** Choose **File > New > Project > PSoC 4000 Starter Designs**. These starter designs demonstrate the unique features of PSoC 4.
- **System Reference Guide:** Choose **Help > System Reference Guides**. This guide lists and describes the system functions provided by PSoC Creator.
- **Component datasheets:** Right-click a Component and select **Open Datasheet**, as shown in [Figure 1-5 on page 12](#). Visit the [PSoC 4 Component Datasheets](#) page for a list of all PSoC 4 Component datasheets.
- **Document Manager:** PSoC Creator provides a document manager to help you to easily find and review document resources. To open the document manager, choose the menu item **Help > Document Manager**.

Figure 1-5. Opening Component Datasheet

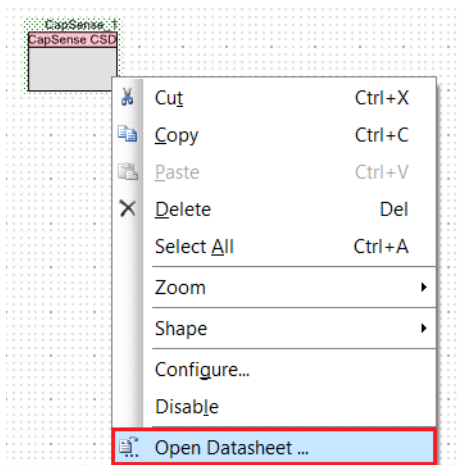

1.3 Getting Started

This guide helps acquaint you with the PSoC 4000 Pioneer Kit.

- The [Software Installation chapter on page 15](#) describes the installation of the kit software.
- The [Kit Operation chapter on page 19](#) explains how to program the PSoC 4 with a programmer and debugger, either the onboard PSoC 5LP or the external MiniProg3 (CY8CKIT-002).
- The [Hardware chapter on page 31](#) details the hardware operation.
- The [Code Examples chapter on page 51](#) describes the example projects that are provided with the kit.
- The [Advanced Topics chapter on page 107](#) deals with topics such as building projects for PSoC 5LP, using onboard F-RAM, USB-UART functionality, and USB-I²C functionality of PSoC 5LP.
- The [Appendix on page 161](#) provides schematics, pin assignments, information on the use of zero-ohm resistors, troubleshooting details, and the bill of materials (BOM).

1.4 Additional Learning Resources

Cypress provides a wealth of information at www.cypress.com to help you to select the right PSoC device for your design, and to help you to quickly and effectively integrate the device into your design. For a comprehensive list of resources, see [KBA86521](#), [How to Design with PSoC 3](#), [PSoC 4](#), and [PSoC 5LP](#). The following is an abbreviated list for PSoC 4:

- Overview: [PSoC Portfolio](#) and [PSoC Roadmap](#)
- Product Selectors: [PSoC 1](#), [PSoC 3](#), [PSoC 4](#), or [PSoC 5LP](#). In addition, [PSoC Creator](#) includes a device selection tool.
- [Datasheets](#): Describe and provide electrical specifications for the PSoC 4 device family.
- [CapSense Design Guide](#): Learn how to design capacitive touch-sensing applications with the PSoC 4 family of devices.
- [Application Notes and Code Examples](#): Cover a broad range of topics, from basic to advanced level. Many of the application notes include code examples. Visit the [PSoC 3/4/5 Code Examples](#) webpage for a list of all available PSoC Creator code examples. To access code examples from within PSoC Creator, see [PSoC Creator Code Examples on page 10](#).
- [Technical Reference Manuals \(TRM\)](#): Provide detailed descriptions of the architecture and registers in each PSoC 4 device family.
- [Development Kits](#):
 - [CY8CKIT-040](#), [CY8CKIT-042](#), and [CY8CKIT-044](#) are easy-to-use and inexpensive development platforms. These kits include connectors for Arduino-compatible shields and Diligent Pmod peripheral modules.
 - [CY8CKIT-049](#) and [CY8CKIT-043](#) are very low-cost prototyping platforms for sampling PSoC 4 devices.
 - The [MiniProg3](#) kit provides an interface for flash programming and debug.
- [Knowledge Base Articles \(KBA\)](#): Provide design and application tips from experts on using the device.
- PSoC Creator Training: Visit www.cypress.com/go/creatorstart/creatortraining for a comprehensive list of video trainings on PSoC Creator.
- Learning From Peers: Visit www.cypress.com/forums to meet enthusiastic PSoC developers discussing the next generation embedded systems on Cypress Developer Community Forums.

1.5 Technical Support

If you have any questions, you can create a support request at the [Cypress Technical Support](#) page.

If you are in the United States, you can talk to our technical support team by calling our toll-free number: +1-800-541-4736. Select option 2 at the prompt. If you are outside United States, you can talk to our technical support team by calling: +1 (408) 943-2600 Ext. 2.

You can also use the following support resources if you need quick assistance.

- [Self-help](#)
- [Local Sales Office Locations](#)

1.6 Documentation Conventions

Table 1-1. Document Conventions for Guides

Convention	Usage
Courier New	Displays file locations, user-entered text, and source code: C:\ ...cd\icc\
<i>Italics</i>	Displays file names and reference documentation: Read about the <i>sourcefile.hex</i> file in the <i>PSoC Creator User Guide</i> .
[Bracketed, Bold]	Displays keyboard commands in procedures: [Enter] or [Ctrl] [C]
File > Open	Represents menu paths: File > Open > New Project
Bold	Displays commands, menu paths, and icon names in procedures: Click the File icon and then click Open .
Times New Roman	Displays an equation: $2 + 2 = 4$
Text in gray boxes	Describes cautions or a unique functionality of the product.

2. Software Installation



This section describes the installation of the CY8CKIT-040 PSoC 4000 Pioneer Kit software and the prerequisites.

2.1 Before You Begin

All Cypress software installations require administrator privileges. However, this is not the case for installed software. Before you install the kit software, close any other Cypress software that is currently running.

2.2 Install Software

Follow these steps to install the CY8CKIT-040 PSoC 4000 Pioneer Kit software:

1. Download the [CY8CKIT-040](#) software.

The CY8CKIT-040 software is available in three different formats for download:

- a. **CY8CKIT-040 Kit Setup:** This installation package contains the files related to the kit. However, it does not include the Windows Installer or Microsoft .NET framework packages. If these packages are not on your computer, the installer directs you to download and install them from the Internet.
- b. **CY8CKIT-040 Kit Only:** This executable file installs only the kit contents, which include kit code examples, hardware files, and user documents. This package can be used if all the software prerequisites listed in step 5 are installed on your PC.
- c. **CY8CKIT-040 CD ISO:** This file is a complete package, stored in a CD-ROM image format that you can use to create a CD or extract using ISO extraction programs, such as WinZip or WinRAR. The file can also be mounted like a virtual CD using virtual drive programs such as Virtual CloneDrive or MagicISO. This file includes all the required software, utilities, drivers, hardware files, and user documents.

2. If you have downloaded the ISO file, mount it in a virtual drive. Extract the ISO contents if you do not have a virtual drive to mount. Double-click *cyautorun.exe* in the root directory of the extracted content or mounted ISO if 'Autorun from CD/DVD' is not enabled in the PC. The installation window shown in Figure 2-1 will appear automatically. **Note:** If you are using the 'Kit Setup' or 'Kit Only' file, then go to step 6 for installation.
3. Click **Install CY8CKIT-040** to start the kit installation, as shown in Figure 2-1.

Figure 2-1. Kit Installer Startup Screen



4. Select the folder in which you want to install the CY8CKIT-040 kit-related files. Choose the directory and click **Next**.
5. When you click **Next**, the CY8CKIT-040 ISO installer automatically installs the required software, if it is not present on your computer.
Following is the required software:
 - a. PSoC Creator 3.1 Service Pack 1 or later: Download the latest version from www.cypress.com/psoccreator.
 - b. PSoC Programmer 3.22.2 or later: Download the latest version from www.cypress.com/programmer.

6. Choose the **Typical/Custom/Complete** installation type in the Product Installation Overview window, as shown in [Figure 2-2](#). Click **Next** after you select the installation type.

Figure 2-2. Product Installation Overview Window

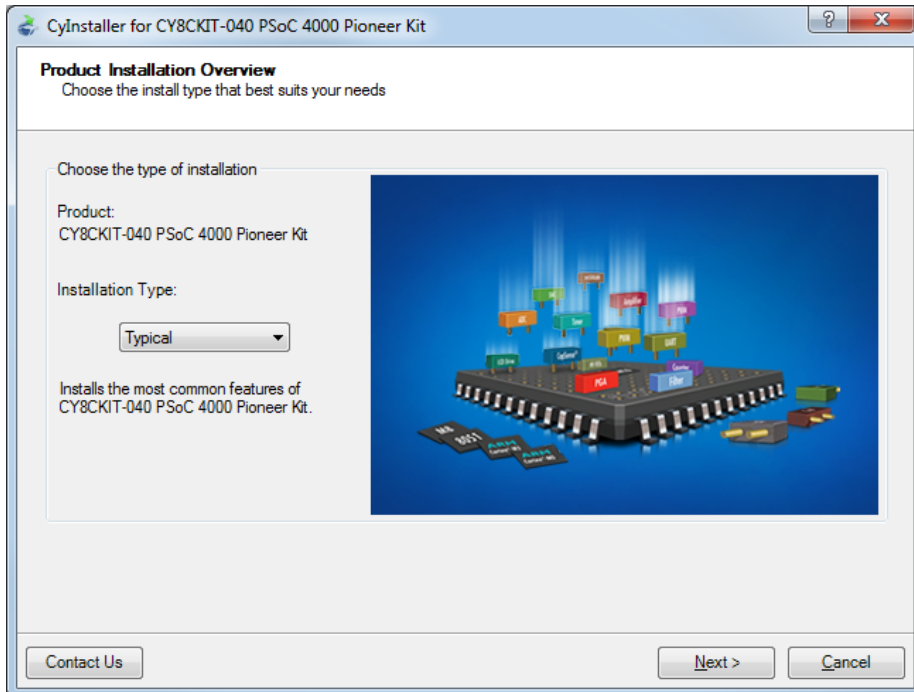

7. Read and Accept the End-User License Agreement and click **Next** to proceed with the installation.
8. When the installation begins, a list of packages appears on the installation page. A green check mark appears next to each package after successful installation.
9. Enter your contact information or select the check box **Continue Without Contact Information**. Click **Finish** to complete the CY8CKIT-040 kit installation.
10. After the installation is complete, the kit contents are available at the following location:

`<Install_Directory>\CY8CKIT-040 PSoC 4000 Pioneer Kit\<version>`

Default location:

Windows 7 (64-bit):

`C:\Program Files (x86)\Cypress\CY8CKIT-040 PSoC 4000 Pioneer Kit\<version>`

Windows 7 (32-bit):

`C:\Program Files\Cypress\CY8CKIT-040 PSoC 4000 Pioneer Kit\<version>`

Note: For Windows 7/8/8.1 users, the installed files and the folder are read only. To change the property, right-click the folder and choose **Properties > Attributes**; disable the **Read-only** check box. Click **Apply** and **OK** to close the window.

2.3 Install Hardware

There is no additional hardware installation required for this kit.

2.4 Uninstall Software

You can uninstall the CY8CKIT-040 PSoC 4000 Pioneer Kit software using one of the following methods:

- Go to **Start > All Programs > Cypress > Cypress Update Manager > Cypress Update Manager**. Select the **Uninstall** button that corresponds to the kit software.
- Go to **Start > Control Panel > Programs and Features** (or **Add/Remove Programs** for Windows XP). Select the **Uninstall/Change** button that corresponds to the kit software.

3. Kit Operation



3.1 Kit Overview

The PSoC 4000 Pioneer Kit can be used to develop applications using the PSoC 4000 family of devices. The kit includes two boards – an Arduino-compatible baseboard and a CapSense-based Trackpad shield board. [Figure 3-1](#) is an image of the PSoC 4000 Pioneer Kit baseboard and shield board with a markup of the onboard components.

Figure 3-1. CY8CKIT-040 Kit Details

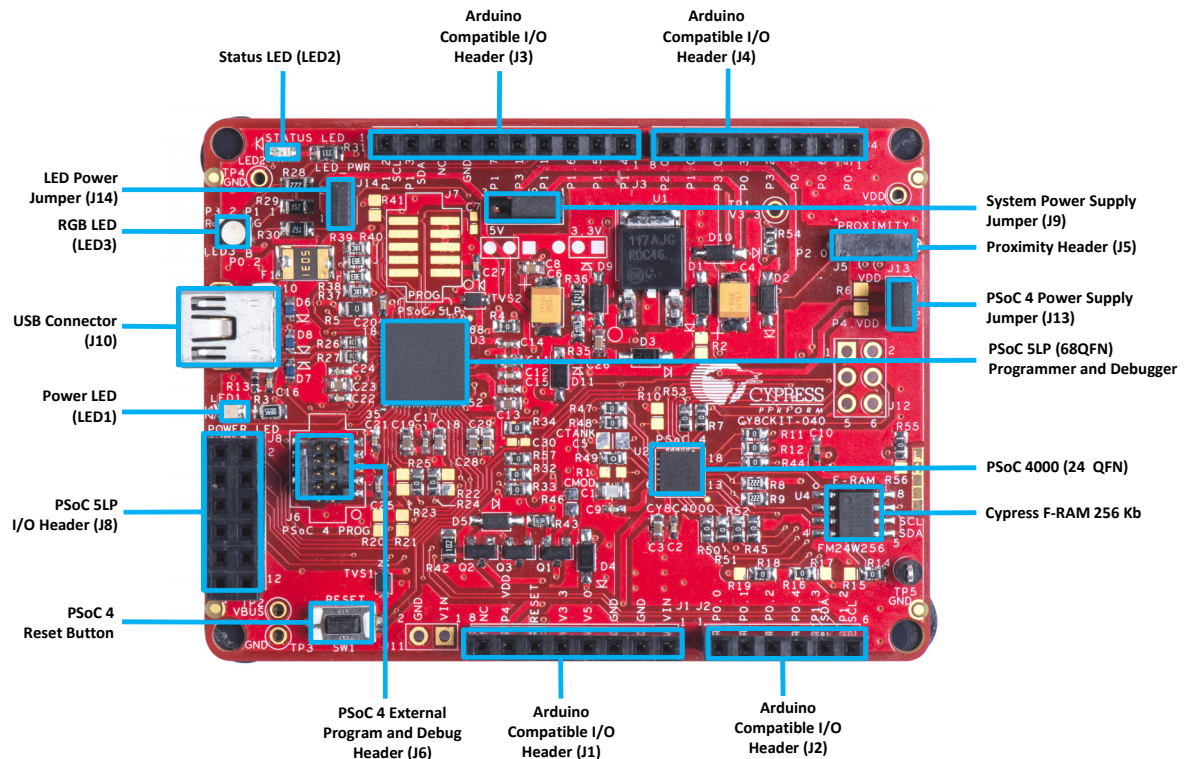

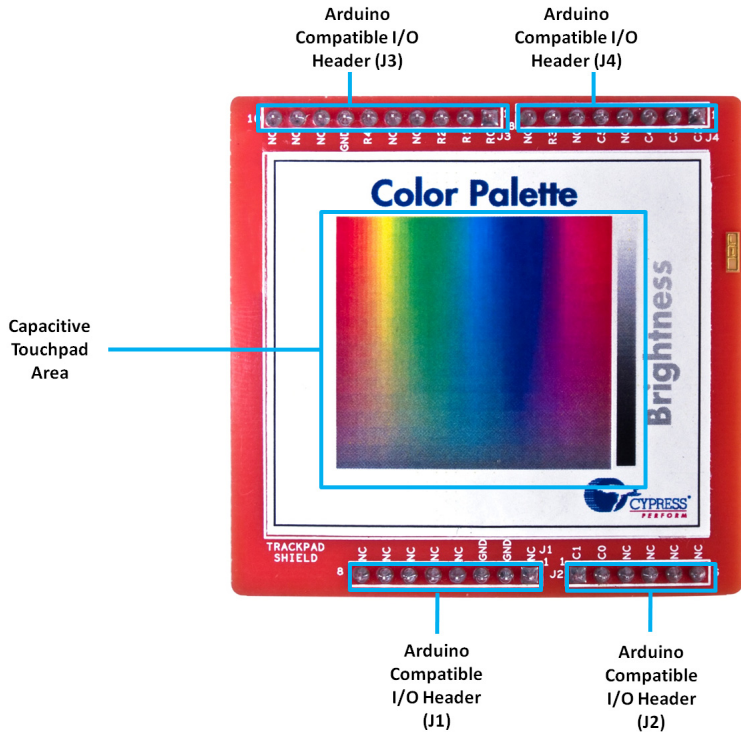

3.2 Kit USB Connection

The PSoC 4000 Pioneer Kit connects to the PC over a USB interface (see Figure 3-2). The kit enumerates as a composite device and three separate devices appear under the **Device Manager** in the Windows operating system. See Table 3-1, and Figure 3-3.

Figure 3-2. Kit USB Connection

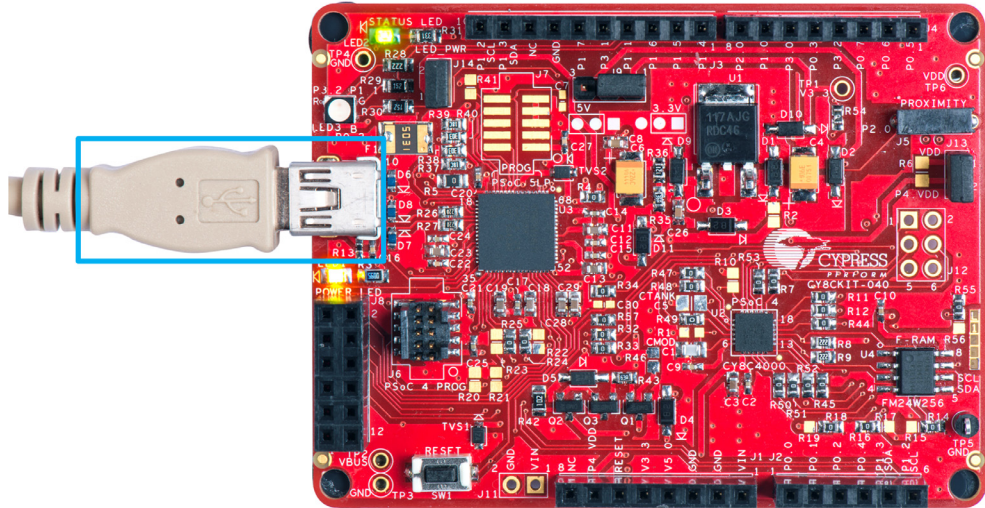
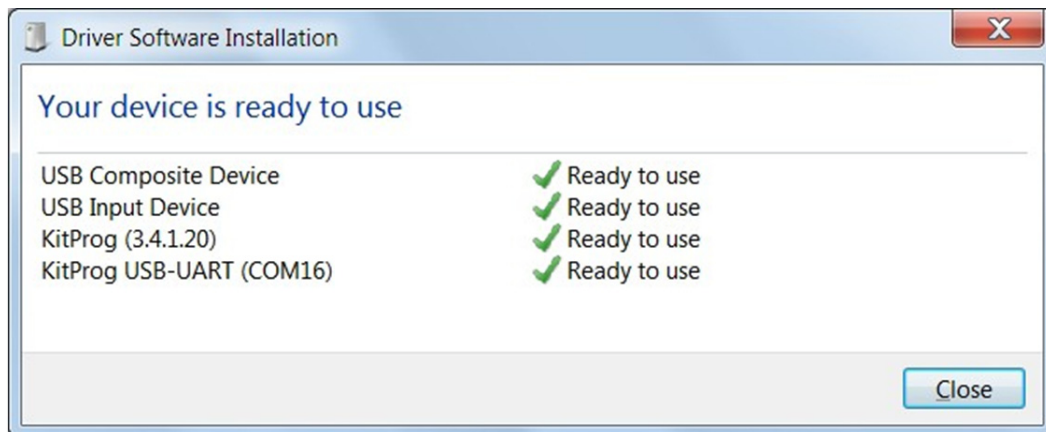

Table 3-1. PSoC 4000 Pioneer Kit in Device Manager After Enumeration

Port	Description
USB Composite Device	Composite device
USB Input Device	USB-I ² C bridge, KitProg command interface
KitProg	USB-I ² C bridge, programmer and debugger
KitProg USB-UART	USB-UART bridge, which appears as the COM# port

Figure 3-3. KitProg Driver Installation Complete



3.3 Programming and Debugging PSoC 4000

The kit allows programming and debugging of the PSoC 4 device in two modes:

- 3.3.1 Using the Onboard PSoC 5LP Programmer and Debugger
- 3.3.2 Using the CY8CKIT-002 MiniProg3 Programmer and Debugger

3.3.1 Using the Onboard PSoC 5LP Programmer and Debugger

The default programming interface for the kit is a USB-based, onboard programming interface. Before trying to program the device, PSoC Creator and PSoC Programmer must be installed. See [Install Software on page 15](#) for information on installing the kit software.

1. To program the device, plug the USB cable into the programming USB connector J10, as shown in [Figure 3-4](#). The kit will enumerate as a composite device. See [Kit USB Connection on page 21](#) for details.

Figure 3-4. Connect USB Cable to J10

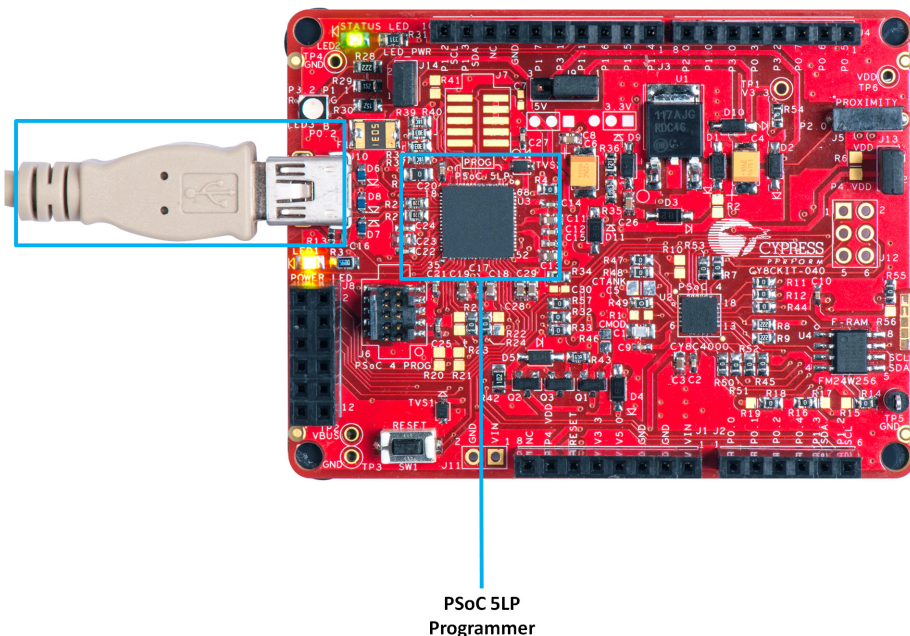

2. The onboard PSoC 5LP uses serial wire debug (SWD) to program the PSoC 4 device. See [Figure 3-5](#).

Note: [Figure 3-5](#) is provided only for reference, all connections are hardwired on the board itself.

Figure 3-5. SWD Programming of PSoC 4000 Using PSoC 5LP

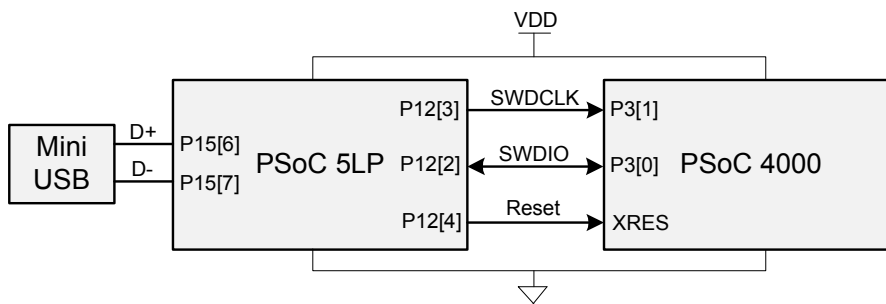

- The kit's onboard programmer will enumerate on the PC and in the software tools as **KitProg**. Open an example project in PSoC Creator (such as [Project: Blinking LED on page 56](#)) and initiate the build by choosing **Build > Build Project** or pressing **[Shift] [F6]**. See [Figure 3-6](#).

Figure 3-6. Build Project in PSoC Creator

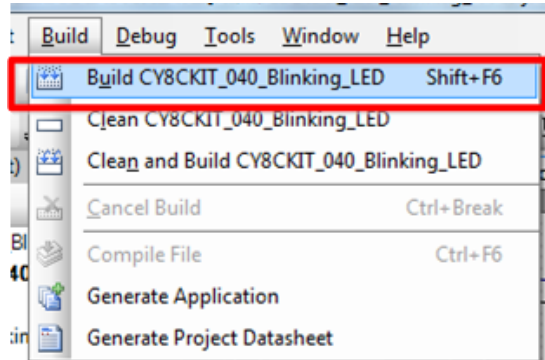

- After the project is built without errors and warnings, choose **Debug > Program** or press **[Ctrl] [F5]** to program the device. See [Figure 3-7](#).

Figure 3-7. Program Device From PSoC Creator

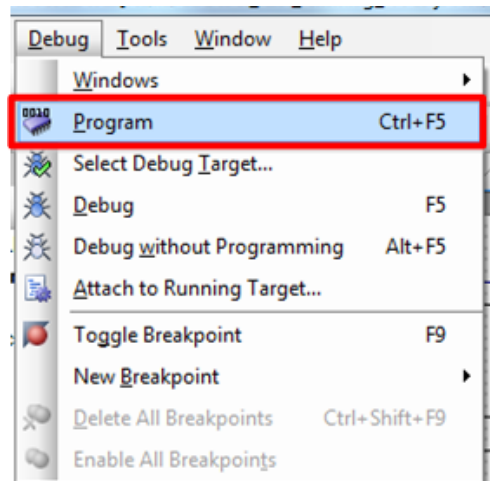

The onboard programmer supports only the RESET programming mode. When using the onboard programmer, the board can either be powered by the USB (VBUS) or by an external source such as an Arduino shield (see [Power Supply System on page 38](#)). If the board is already powered from another source, plugging in the USB programmer does not damage the board.

3.3.2 Using the CY8CKIT-002 MiniProg3 Programmer and Debugger

The PSoC 4 on the kit can also be programmed using a MiniProg3 (CY8CKIT-002). To use MiniProg3 for programming, use the J6 connector on the board, as shown in [Figure 3-8](#). With MiniProg3, programming is similar to the onboard programmer; however, it enumerates as MiniProg3 instead of KitProg.

The board can also be powered from the MiniProg3. To do so, choose **Tool > Options** in PSoC Creator. In the Options window, expand **Program/Debug > Port Configuration**; click **MiniProg3** and select the settings shown in [Figure 3-9](#). Choose **Debug > Program** to program and power the board.

Note The CY8CKIT-002 MiniProg3 is not part of the PSoC 4000 Pioneer Kit contents. It can be purchased from the [Cypress Online Store](#).

Figure 3-8. PSoC 4 Programming/Debug Using MiniProg3

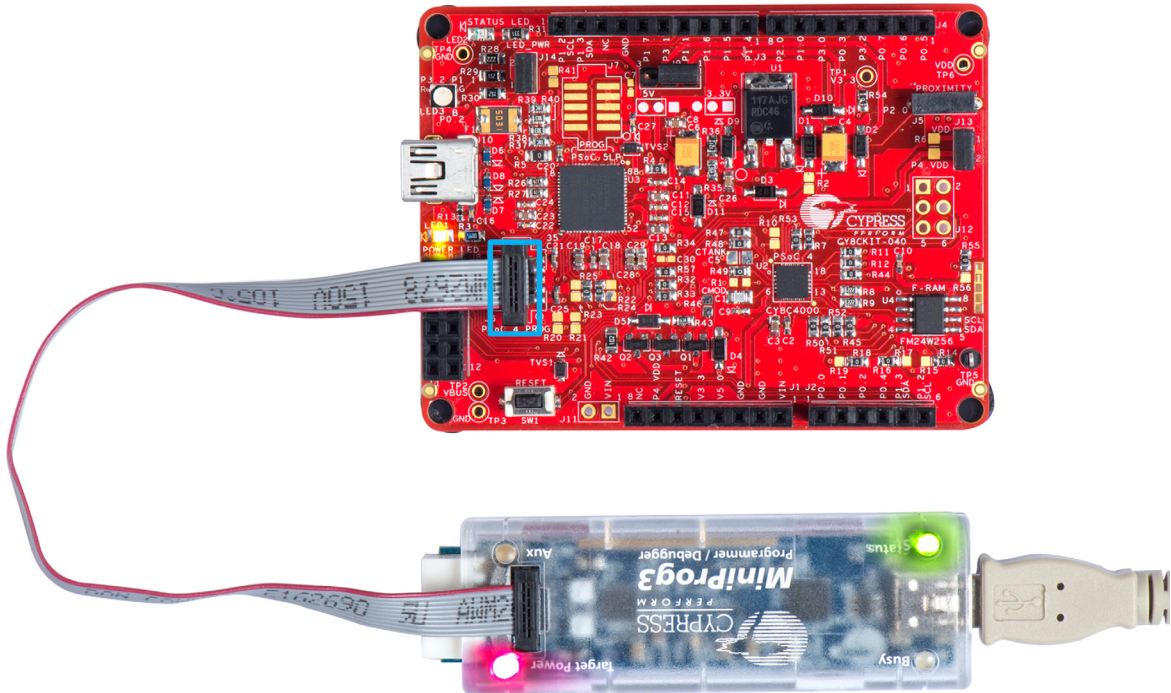
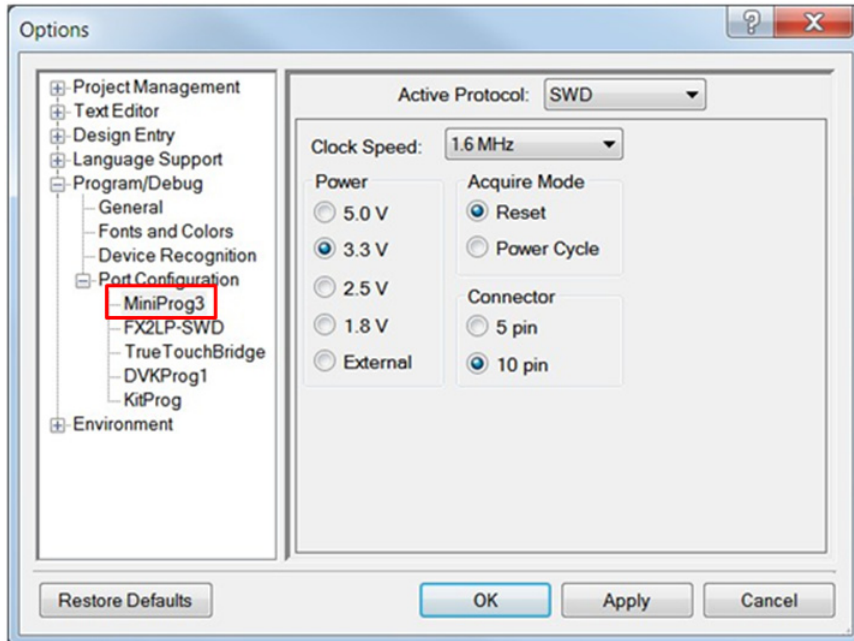

Figure 3-9. MiniProg3 Configuration in PSoC Creator



Note: Ensure that both MiniProg3 (with or without power) on header J6 and KitProg are not connected to the onboard PSoC 4 at the same time. This will result in failed device acquisition from both.

3.4 USB-I²C Bridge

The PSoC 5LP also functions as a USB-I²C bridge. The PSoC 4 communicates with the PSoC 5LP using an I²C interface, and the PSoC 5LP transfers the data over the USB to the USB-I²C software utility on the PC called the Bridge Control Panel (BCP).

The BCP is available as part of the PSoC Programmer installation. This software can be used to send and receive USB-I²C data from the PSoC 5LP. When the USB Mini-B cable is connected to header J10 on the PSoC 4000 Pioneer Kit, the **KitProg USB-I²C** is available under **Connected I2C/SPI/RX8 Ports** in the BCP, as shown in [Figure 3-10](#).

Figure 3-10. Bridge Control Panel

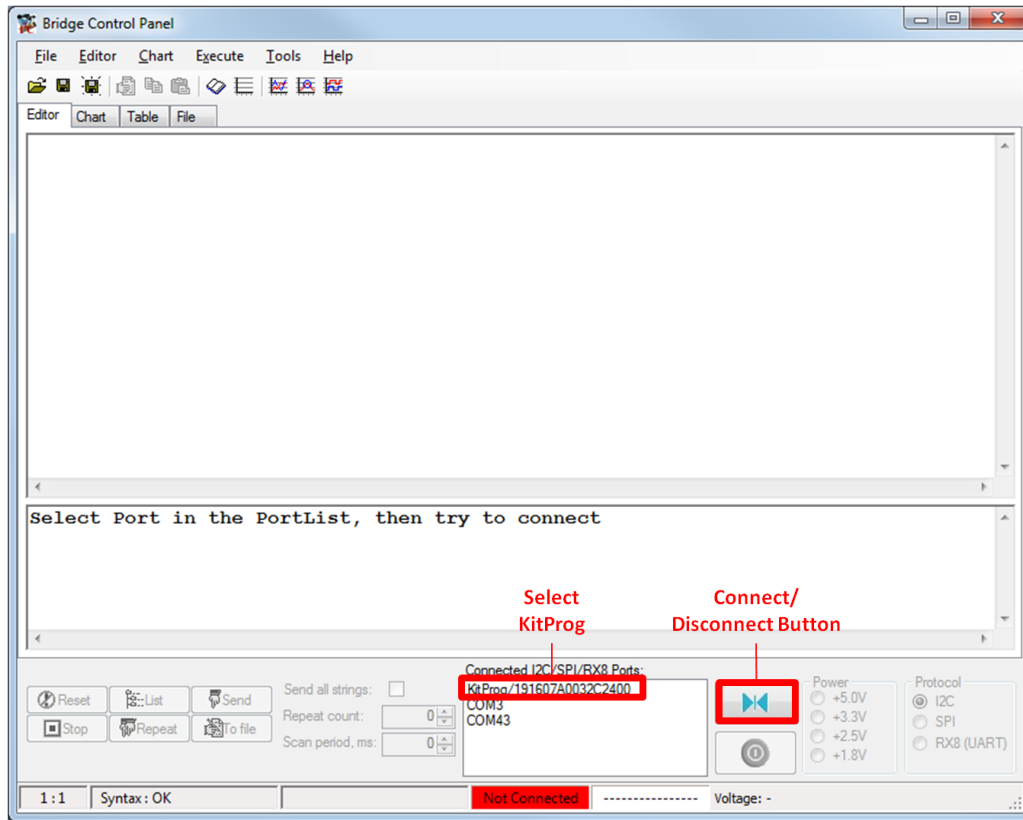

To use the USB-I²C functionality, select the **KitProg USB-I²C** in the BCP (Figure 3-10). On successful connection, the **Connected** and **Powered** status boxes turn green (Figure 3-11).

Figure 3-11. KitProg USB-I²C Connected in Bridge Control Panel

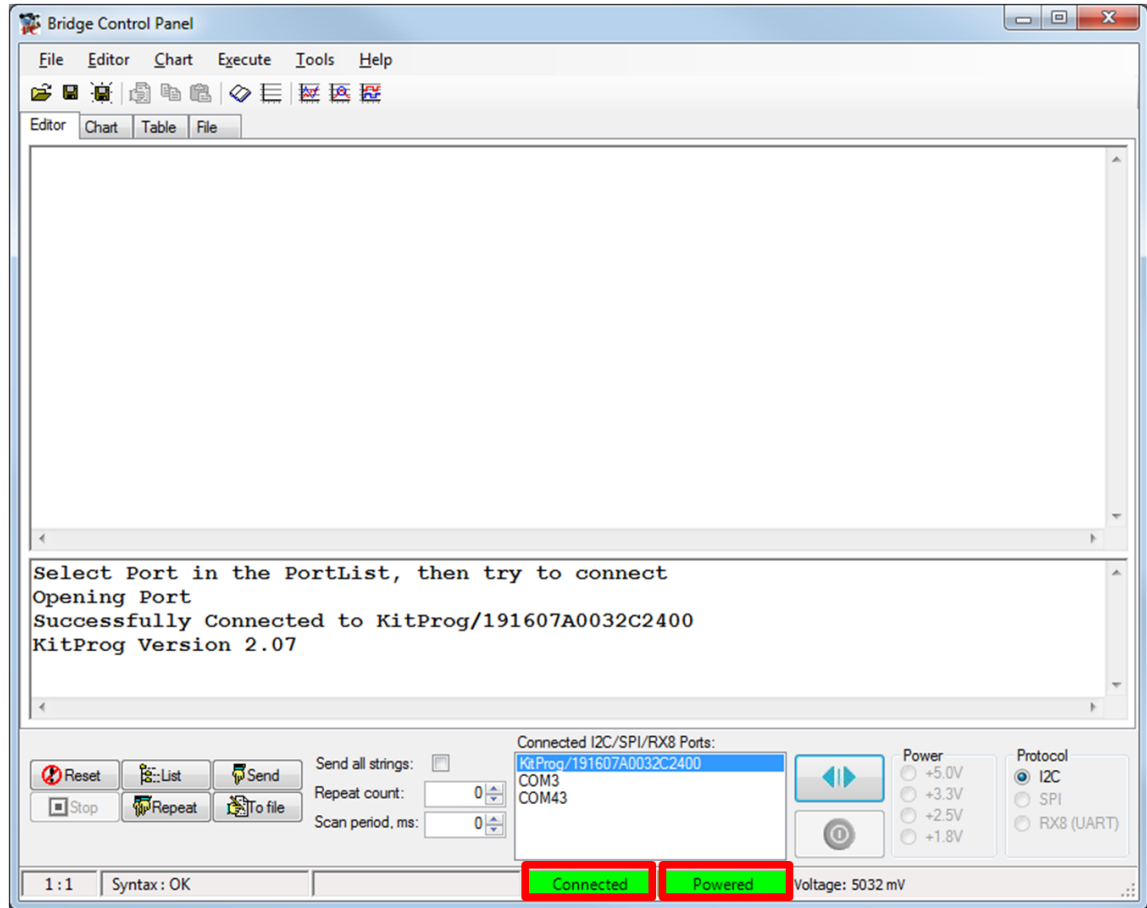

USB-I²C is implemented using the USB and I²C components of PSoC 5LP. The SCL (P12_0) and SDA (P12_1) lines from the PSoC 5LP are connected to the SCL (P1_2) and SDA (P1_3) lines of the PSoC 4 I²C. The USB-I²C bridge currently supports I²C speed of 50 kHz, 100 kHz, 400 kHz, and 1 MHz.

See [Using PSoC 5LP as a USB-I2C Bridge on page 107](#) for building a project that uses the USB-I²C bridge functionality.

3.5 USB-UART Bridge

The onboard PSoC 5LP can also act as a USB-UART bridge to transfer and receive data from the PSoC 4 device to the PC via the COM terminal software. When the USB Mini-B cable is connected to J10 of the PSoC 4000 Pioneer Kit, a device named **KitProg USB-UART** is available under **Ports (COM & LPT)** in the Device Manager. For more information about the USB-UART functionality, see [Using PSoC 5LP as a USB-UART Bridge on page 120](#).

To use the USB-UART functionality in the COM terminal software, select the corresponding COM port as the communication port for transferring data to and from the COM terminal software.

The UART lines from PSoC 5LP are brought to the P12[6] (J8_9) and P12[7] (J8_10) pins of header J8. This interface can be used to send or receive data from any design/device that has a UART by connecting the pins on header J8 to the RX and TX pins available on the connecting device.

Note: The PSoC 4000 family that is featured in the kit board does not support a full-duplex UART; it can support only a software-based UART transmit on any pin. On the board, P3[0] of the PSoC 4000 device is hardwired to the UART bridge's RX line through zero-ohm resistor R57.

Table 3-2 lists the specifications supported by the USB-UART bridge.

Table 3-2. Specifications Supported by USB-UART Bridge

Parameter	Supported Values
Baud rate	1200, 2400, 4800, 9600, 19200, 38400, 57600, and 115200
Data bits	8
Parity	None
Stop bits	1
Flow control	None
File transfer protocols supported	Xmodem, 1K Xmodem, Ymodem, Kermit, and Zmodem (only speeds greater than 2400 baud).

3.6 Updating the Onboard Programmer Firmware

The firmware of the onboard programmer and debugger (KitProg), PSoC 5LP, can be updated from PSoC Programmer. When a new firmware is available or when the KitProg firmware is corrupt (see [KitProg Status LED States on page 170](#)), PSoC Programmer displays a warning indicating that new firmware is available.

Open PSoC Programmer from **Start > All Programs > Cypress > PSoC Programmer<version>**. When PSoC Programmer opens, a WARNING! window pops up saying that the programmer is currently out of date, as shown in [Figure 3-12](#).

Figure 3-12. Firmware Update Warning

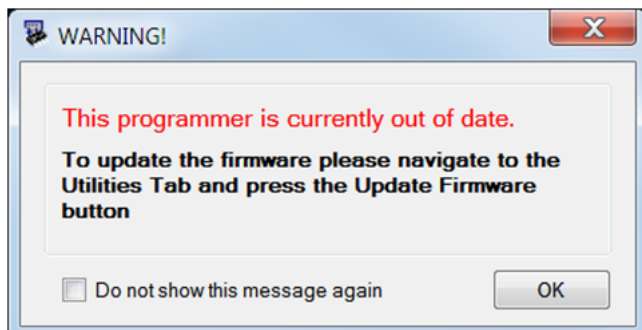

Click **OK** to close the window. On closing the warning window, the **Actions** and **Results** window displays **Please navigate to the Utilities tab and click the Upgrade Firmware button**, as shown in Figure 3-13.

Figure 3-13. Upgrade Firmware Message in PSoC Programmer

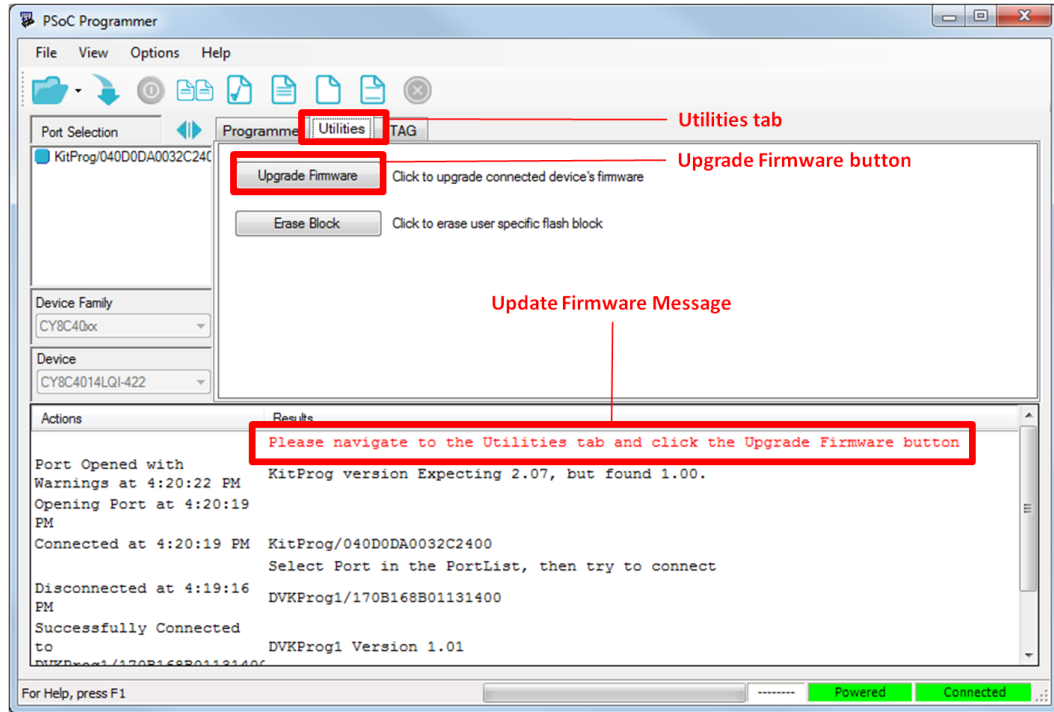

Click the **Utilities** tab and click the **Upgrade Firmware** button. On successful upgrade, the **Actions** and **Results** window displays the firmware update message with the KitProg version, as shown in Figure 3-14.

Figure 3-14. Firmware Updated in PSoC Programmer

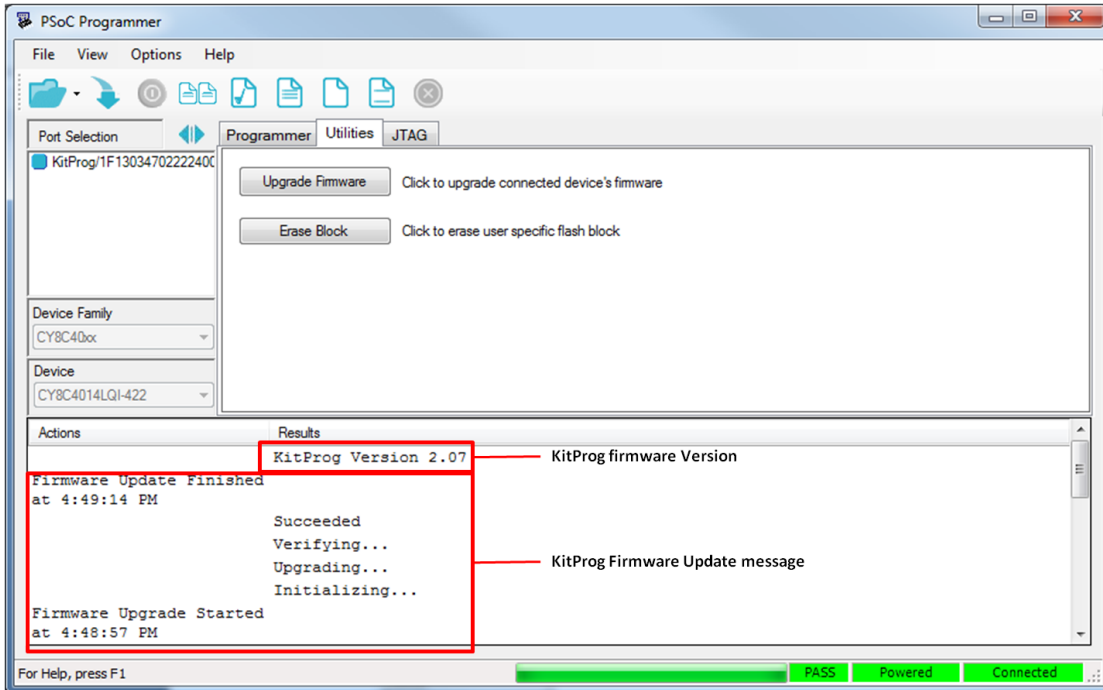

4. Hardware



4.1 Board Details

The PSoC 4000 Pioneer Kit consists of the following blocks:

- CY8CKIT-040 baseboard (see [Figure 4-1](#)) -
 - PSoC 4 (4000 family)
 - PSoC 5LP
 - Power supply system
 - Coin cell battery holder (BT1)
 - Programming interfaces (J6, and J10)
 - Arduino compatible headers (J1, J2, J3, J4, and J12)
 - PSoC 5LP GPIO header (J8)
 - Proximity header (J5)
 - Pioneer board LEDs
 - Push button (Reset button)
 - Cypress ferroelectric RAM (F-RAM)
- CY8CKIT-040 CapSense Trackpad shield board (see [Figure 4-2](#))

Note: Programming header J7 is not populated by default.

Figure 4-1. CY8CKIT-040 - Baseboard Details

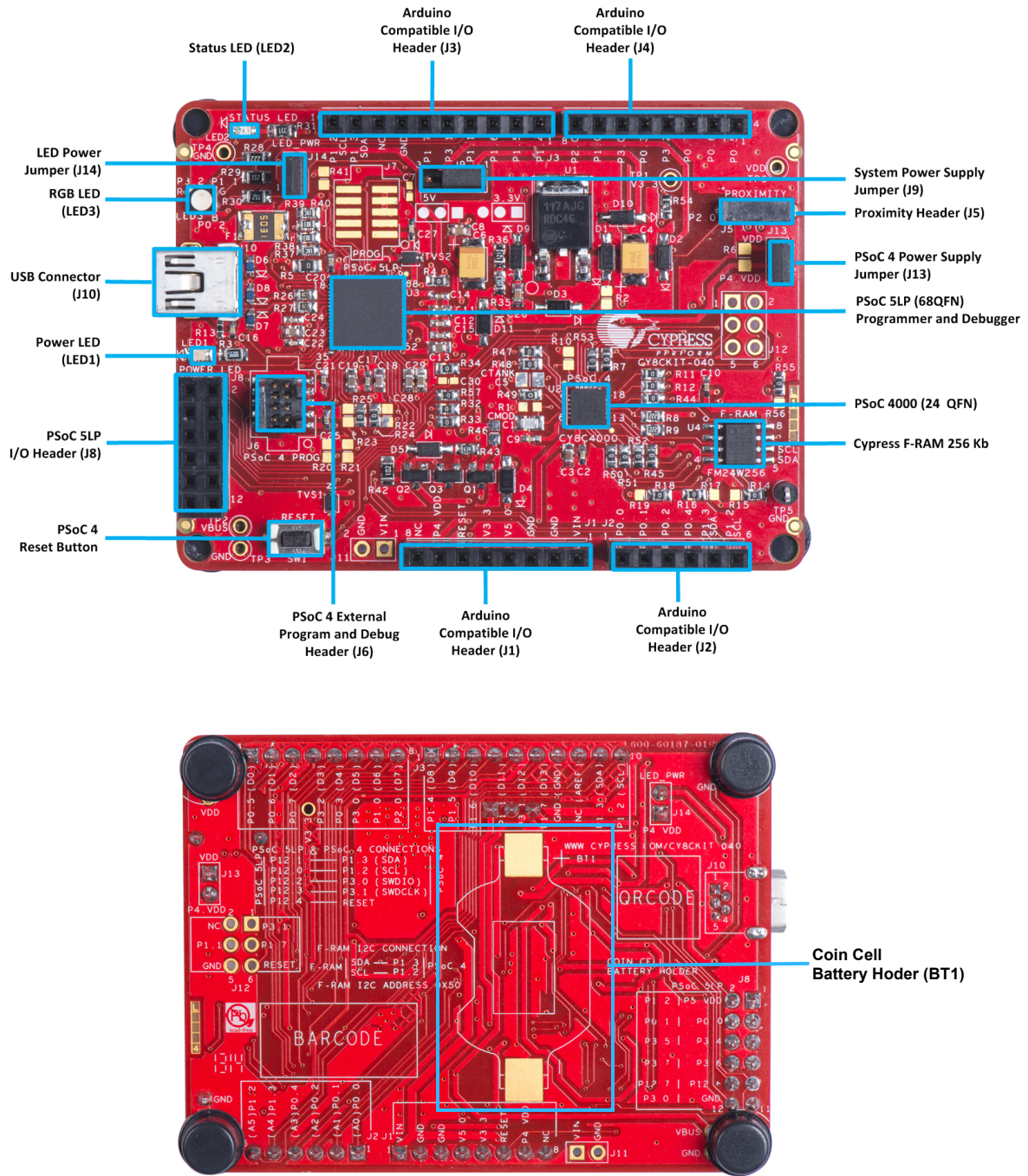

Figure 4-2. CY8CKIT-040 CapSense Trackpad Shield Board Details

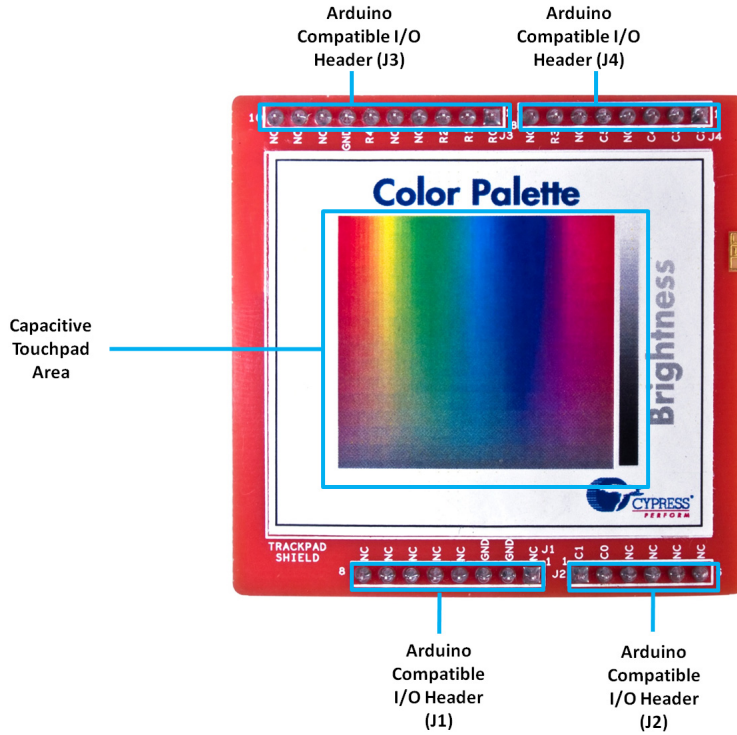
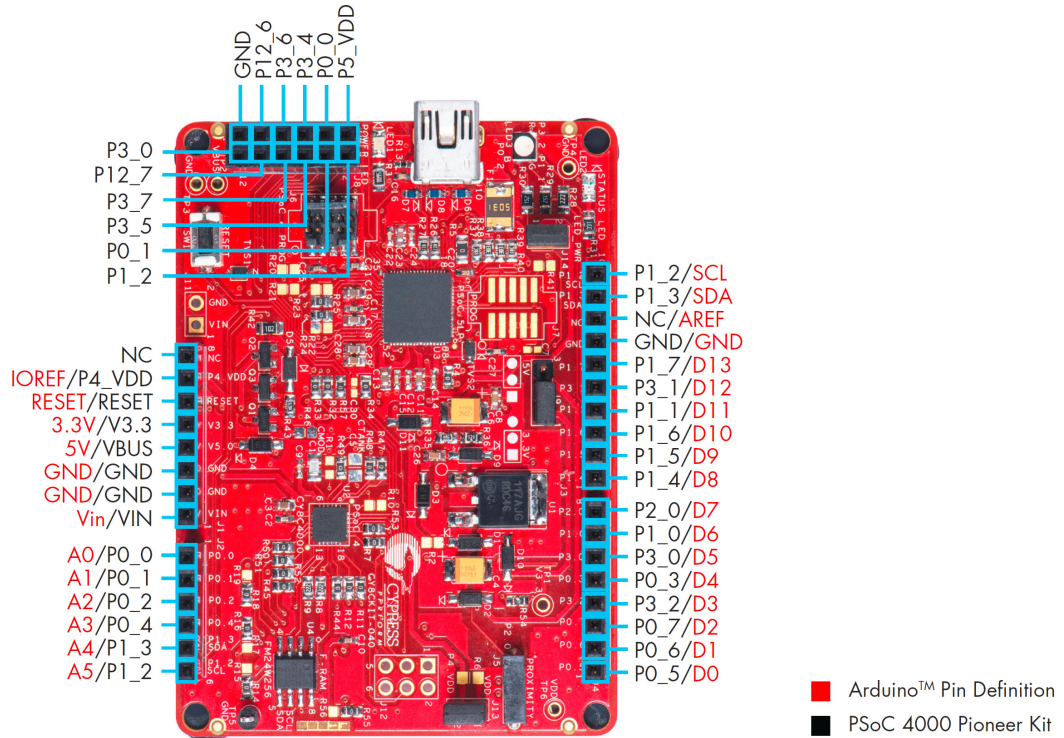

Figure 4-3. PSoC 4000 Pioneer Kit Pin Mapping



4.2 Block Diagram

This section provides the block-level description of the PSoC 4000 Pioneer Kit, as illustrated in Figure 4-4.

Figure 4-4. Block Diagram

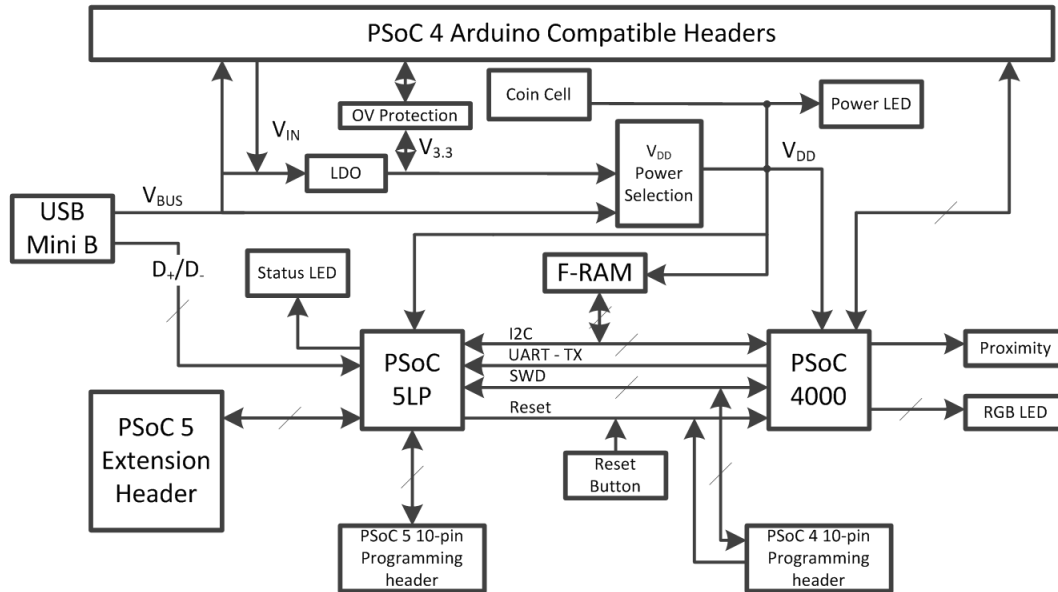

PSoC 4 is a new generation of programmable system-on-chip devices from Cypress for embedded applications. The PSoC 4000 family is the smallest member of the PSoC 4 platform with CapSense, TCPWM, I²C master or slave, and up to 20 GPIOs support. PSoC 4000 is a cost-optimized, entry-level PSoC4 device targeted as socket replacements for obsolete and/or proprietary 8-bit and 16-bit MCUs. PSoC 4000 with its ARM Cortex-M0 core brings 32 CapSense and programmable peripherals.

The kit features an onboard PSoC 5LP, which communicates through the USB to program and debug the PSoC 4 using SWD. The PSoC 5LP also functions as a USB-I²C bridge and USB-UART bridge. It can also be used to develop PSoC 5LP based applications (see [Developing Applications for PSoC 5LP on page 133](#)).

The kit includes an RGB LED, a status LED, and a power LED. The RGB LED is connected to the PSoC 4, and the status LED is connected to the PSoC 5LP. This kit also includes a Reset button that connects to the PSoC 4 XRES, a CapSense proximity header, and a 6x5 elements Trackpad board that is Arduino shield-compatible and can be used to develop touch-based applications. The PSoC 4 pins are brought out onto headers J1 to J4 on the kit to support Arduino shields. The PSoC 5LP pins are brought out onto header J8 to enable using the onboard PSoC 5LP to develop custom applications.

The PSoC 4000 Pioneer Kit can be powered from the USB Mini-B, the Arduino compatible header, an external power supply, or an optional coin cell battery. The input voltage is regulated by a low drop out (LDO) regulator to 3.3 V. You can select between V_{BUS} (5 V) and 3.3 V by suitably plugging the jumper onto the voltage selection header J9. V_{DD} can also be supplied by a coin cell battery placed in the BT1 coin cell holder. The voltage supplied by the coin cell is directly connected to the V_{DD} line through a diode, D11. Take care to ensure that V_{DD} does not exceed the device's V_{DD} specification (1.8 V to 5.5 V).

4.3 Kit Component Details

4.3.1 CY8CKIT-040 Baseboard Components

4.3.1.1 PSoC 4

This kit uses the PSoC 4000 family device. PSoC 4 is the architecture of programmable embedded system controllers with an ARM Cortex-M0 CPU. PSoC 4 delivers a programmable platform for embedded applications. The CY8C40 family is the smallest member of the PSoC 4 family of devices and is upward compatible with larger members of PSoC 4.

For more information, refer to the [PSoC 4 web page](#) and the [PSoC 4000 family datasheet](#).

Features

■ 32-bit MCU Subsystem

- 16-MHz ARM Cortex-M0 CPU
- Up to 16 KB of flash with Read Accelerator
- Up to 2 KB of SRAM

■ Programmable Analog

- Two current DACs (IDACs) for general-purpose or capacitive sensing applications
- One low-power comparator with internal reference

■ Low Power 1.71-V to 5.5-V Operation

- Deep Sleep mode with wake-up on interrupt and I2C address detect

■ Capacitive Sensing

- Cypress Capacitive Sigma-Delta (CSD) provides best-in-class signal-to-noise ratio (SNR) and water tolerance
- Cypress-supplied software component makes capacitive sensing design easy
- Automatic hardware tuning (SmartSense™)

■ Serial Communication

- Multimaster I2C block with the ability to do address matching during Deep Sleep and generate a wake-up on match

■ Timing and Pulse-Width Modulation

- One 16-bit Timer/Counter/Pulse-Width Modulator (TCPWM) block
- Center-aligned, Edge, and Pseudo-Random modes
- Comparator-based triggering of Kill signals for motor drive and other high-reliability digital logic applications

■ Up to 20 Programmable GPIO Pins

- 24-pin QFN, 16-pin SOIC, 16-pin QFN, and 8-pin SOIC packages
- GPIO pins on Ports 0, 1, and 2 can be CapSense or have other functions
- Drive modes, strengths, and slew rates are programmable

■ PSoC Creator Design Environment

- Integrated Development Environment (IDE) provides schematic design entry and build (with analog and digital automatic routing)
- Applications Programming Interface (API) component for all fixed-function and programmable peripherals

- **Industry-Standard Tool Compatibility**

- After schematic entry, development can be done with ARM-based industry-standard development tools

4.3.1.2 PSoC 5LP

An onboard PSoC 5LP (CY8C5868LTI-LP039) is used to program and debug PSoC 4. The PSoC 5LP connects to the USB port of the PC through a USB Mini-B connector and to the SWD interface of the PSoC 4 device.

PSoC 5LP is a true system-level solution providing MCU, memory, analog, and digital peripheral functions in a single chip. The CY8C58LPxx family offers a modern method of signal acquisition, signal processing, and control with high accuracy, high bandwidth, and high flexibility. Analog capability spans the range from thermocouples (near DC voltages) to ultrasonic signals. For more information, refer to the [PSoC 5LP web page](#).

Features

- 32-bit ARM Cortex-M3 CPU core
 - DC to 67-MHz operation
 - Flash program memory up to 256 KB, 100,000 write cycles, 20-year retention, and multiple security features
 - Up to 32-KB flash error correcting code (ECC) or configuration storage
 - Up to 64-KB SRAM
 - 2-KB electrically erasable programmable read-only memory (EEPROM) memory, 1M cycles, and 20 years' retention
 - 24-channel direct memory access (DMA) with multilayer AHB bus access
 - Programmable chained descriptors and priorities
 - High-bandwidth 32-bit transfer support
- Low voltage, ultralow power
 - Wide operating voltage range: 0.5 V to 5.5 V
 - High-efficiency boost regulator from 0.5-V input to 1.8-V to 5.0-V output
 - 3.1 mA at 6 MHz (2.7 V to 5.5 V)
 - Low-power modes including:
 - 2- μ A sleep mode with real-time clock (RTC) and low-voltage detect (LVD) interrupt
 - 300-nA hibernate mode with RAM retention
- Versatile I/O system
 - 28 to 72 I/Os (62 GPIOs, 8 SIOs, 2 USBIOs)
 - Any GPIO to any digital or analog peripheral routability
 - LCD direct drive from any GPIO, up to 46 \times 16 segments
 - CapSense support on any GPIO
 - 1.2-V to 5.5-V I/O interface voltages, up to four domains
 - Maskable, independent IRQ on any pin or port
 - Schmitt-trigger transistor-transistor logic (TTL) inputs
 - All GPIOs configurable as open drain high/low, pull-up/pull-down, High-Z, or strong output
 - Configurable GPIO pin state at power-on reset (POR)
 - 25-mA sink on SIO

- Digital peripherals
 - 20 to 24 programmable logic device (PLD)-based universal digital blocks (UDBs)
 - Full CAN 2.0b 16 RX, 8 TX buffers
 - Full-Speed (FS) USB 2.0 12 Mbps using internal oscillator
 - Four 16-bit configurable timers, counters, and PWM blocks
 - 67-MHz, 24-bit fixed point digital filter block (DFB) to implement finite impulse response (FIR) and infinite impulse response (IIR) filters
 - Library of standard peripherals
 - 8-, 16-, 24-, and 32-bit timers, counters, and PWMs
 - Serial peripheral interface (SPI), universal asynchronous transmitter receiver (UART), and I²C
 - Many others available in Component catalog available in PSoC Creator IDE
 - Library of advanced peripherals
 - Cyclic redundancy check (CRC)
 - Pseudo random sequence (PRS) generator
 - Local interconnect network (LIN) bus 2.0
 - Quadrature decoder
- Analog peripherals ($1.71\text{ V} \leq V_{DDA} \leq 5.5\text{ V}$)
 - 1.024 V \pm 0.1 percent internal voltage reference across $-40\text{ }^{\circ}\text{C}$ to $+85\text{ }^{\circ}\text{C}$
 - Configurable delta-sigma ADC with 8- to 20-bit resolution
 - Sample rates up to 192 ksps
 - Programmable gain stage: $\times 0.25$ to $\times 16$
 - 12-bit mode, 192 ksps, 66-dB signal-to-noise and distortion ratio (SINAD), ± 1 -bit INL/DNL
 - 16-bit mode, 48 ksps, 84-dB SINAD, ± 2 -bit INL, ± 1 -bit DNL
 - Up to two SAR ADCs, each 12-bit at 1 Msps
 - Four 8-bit 8 Msps current IDACs or 1 Msps voltage VDACs
 - Four comparators with 95 ns response time
 - Four uncommitted opamps with 25 mA drive capability
 - Four configurable multifunction analog blocks; example configurations are programmable gain amplifier (PGA), transimpedance amplifier (TIA), mixer, and sample and hold
 - CapSense support
- Programming, debug, and trace
 - JTAG (4-wire), SWD (2-wire), single-wire viewer (SWV), and TRACEPORT interfaces
 - Cortex-M3 flash patch and breakpoint (FPB) block
 - Cortex-M3 Embedded Trace Macrocell™ (ETM™) that generates an instruction trace stream
 - Cortex-M3 data watchpoint and trace (DWT) that generates data trace information
 - Cortex-M3 Instrumentation Trace Macrocell (ITM) that can be used for printf-style debugging
 - DWT, ETM, and ITM blocks that communicate with off-chip debug and trace systems via the SWV or TRACEPORT
 - Bootloader programming supportable through I²C, SPI, UART, USB, and other interfaces

- Precision, programmable clocking
 - 3- to 62-MHz internal oscillator over full temperature and voltage range
 - 4- to 25-MHz crystal oscillator for crystal PPM accuracy
 - Internal PLL clock generation up to 67 MHz
 - 32.768-kHz watch crystal oscillator
 - Low-power internal oscillator at 1, 33, and 100 kHz

For more information, see the [CY8C58LPxxx family datasheet](#).

4.3.1.3 Power Supply System

The power supply system on this board is versatile, allowing the input supply to come from the following sources:

- 5-V power from onboard USB programming header J10
- 5-V to 12-V power from Arduino shield using J1_01 (VIN on J1) header
- VTARG - power from the onboard SWD programming using J6 or J7
- VIN - J11 (not populated by default)
- Coin cell battery - BT1 (not populated by default)

The PSoC 4 and PSoC 5LP are powered with either a 3.3 V or 5 V source. The selection between 3.3 V and 5 V is made through the J9 jumper. The board can supply 3.3 V and 5 V to the I/O headers and receive 3.3 V from the I/O headers (J9 should select 3.3 V for this). The board can also be powered with an external power supply through the VIN (J11) header; the allowed voltage range for the VIN is 5 V to 12 V. The LDO regulator regulates the VIN down to 3.3 V. [Figure 4-5](#) shows the power supply block diagram and circuitry. In addition, there is a coin cell battery holder (BT1), which can power the VDD line directly. The allowed voltage range supported through the coin cell battery is between 1.8 V and 5.5 V (VDD specification of PSoC 4000 family). The BT1 holder is not populated on the board by default. BU2032SM-BT-GTR (from Keystone Electronics) can be used for BT1. This part supports CR2032 type coin cell batteries. Refer to the [Bill of Materials on page 171](#) for details on other parts that can be used for BT1.

Note: The 5-V domain is directly powered by the USB (VBUS). For this reason, this domain is unregulated.

Figure 4-5. Power Supply Block Diagram and Schematic with Protection Circuits

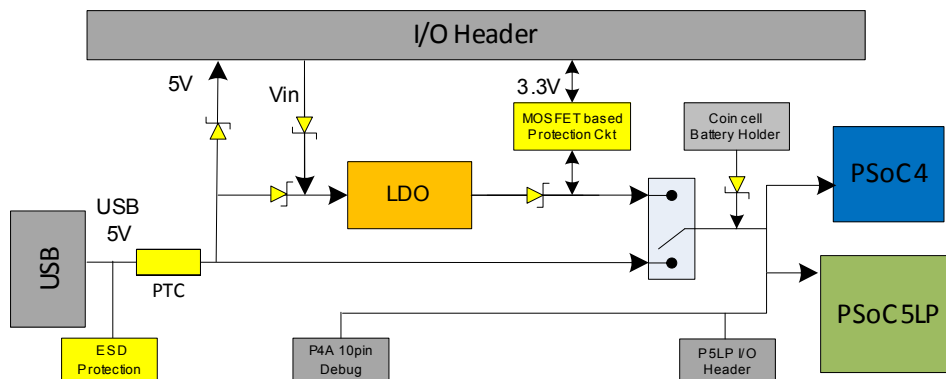

Input Voltage Range VIN is 5-12V

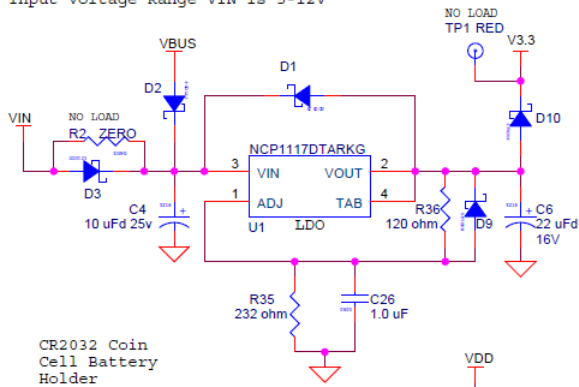

CR2032 Coin Cell Battery Holder

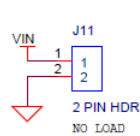
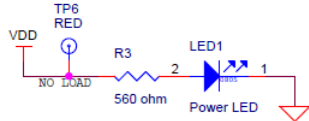
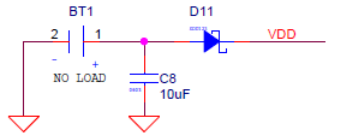

Power Supply

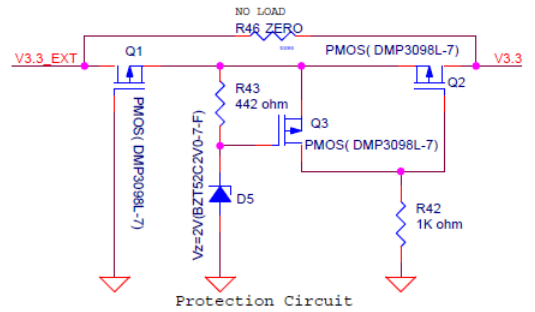

Protection Circuit

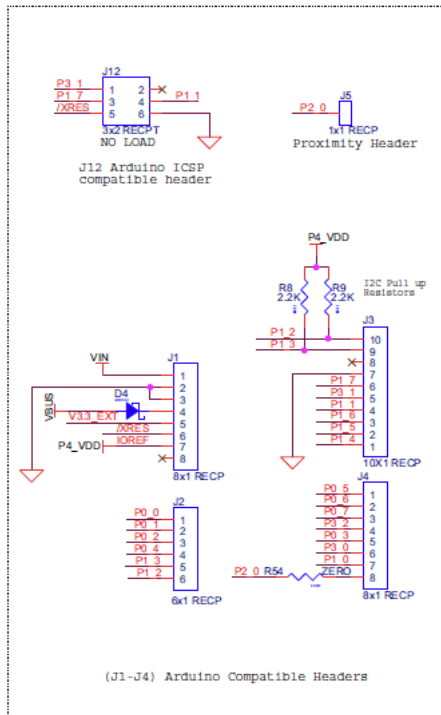

(J1-J4) Arduino Compatible Headers

Protection Circuit

The power supply rail has reverse-voltage, overvoltage, short circuits, and excess current protection features, as seen in [Figure 4-5](#).

- The Schottky diode (D4) ensures power cannot be supplied to the 5-V domain of the board from the I/O header.
- The series protection diode (D3) ensures VIN (power supply from the I/O header) does not back power the USB.
- The Schottky diode (D10) ensures 3.3 V from I/O header does not back power the LDO.
- The series protection diode (D3) ensures that the reverse voltage cannot be supplied from the VIN to the regulator input.
- A PTC resettable fuse is connected to protect the computer's USB ports from shorts and over current.
- The MOSFET-based protection circuit provides overvoltage and reverse-voltage protection to the 3.3-V rail. The PMOS Q1 protects the board components from a reverse-voltage condition. The PMOS Q2 protects the PSoC from an overvoltage condition. The PMOS Q2 will turn off when a voltage greater than 3.6 V is applied, protecting the PSoC 4.
- The output voltage of the LDO is adjusted such that it takes into account the voltage drop across the Schottky diode and provides 3.3 V.
- Populating R46 with a zero-ohm resistor will bypass the MOSFET-based protection circuitry.

Procedure to Measure PSoC 4 Current Consumption

The following two methods are supported for measuring current consumption of the PSoC 4 device.

- When the board is powered through the USB port (J10), remove jumper J13 and connect an ammeter, as shown in [Figure 4-6](#).

Figure 4-6. PSoC 4 Current Measurement When Powered From USB Port

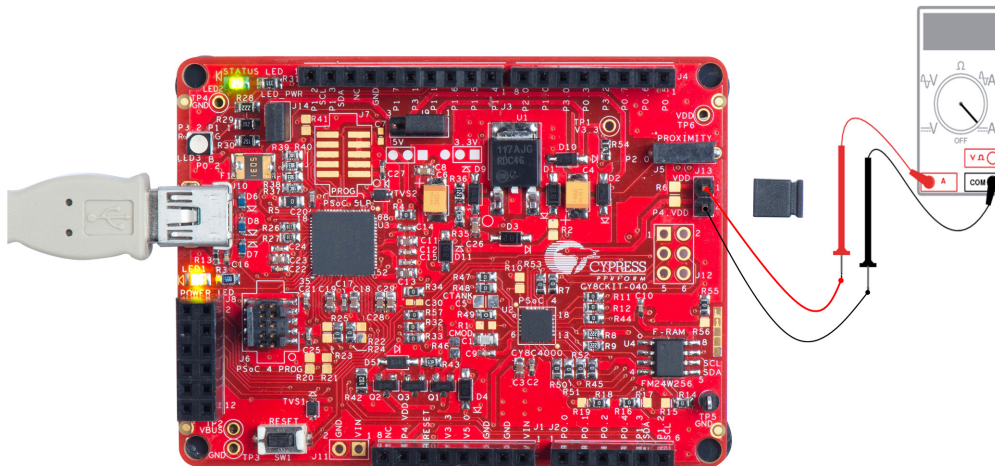

- When using a separate power supply for the PSoC 4 with USB powering (regulator output on the USB supply must be within 0.5 V of the separate power supply), remove jumper J13. Connect the positive terminal of voltage supply to the positive terminal of the ammeter and the negative terminal of the ammeter to the lower pin (P4.VDD) of J13. [Figure 4-7](#) shows the required connections.

Figure 4-7. PSoC 4 Current Measurement When Powered Separately

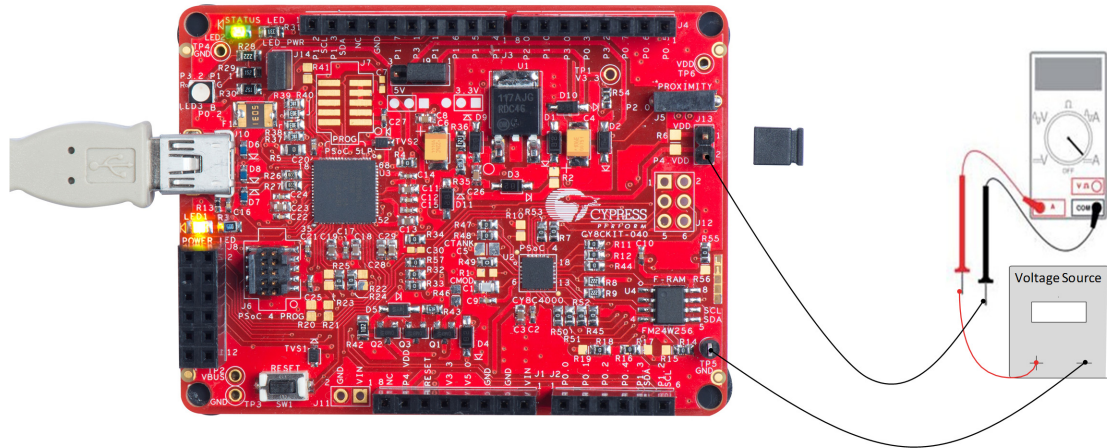

Note: The RGB tricolor LED is powered from PSoC 4 VDD only. Remove jumper J14 to measure power consumed by PSoC 4 alone.

4.3.1.4 Programming Interface

The kit allows programming and debugging of the PSoC 4 in two modes:

- [Using the Onboard PSoC 5LP Programmer and Debugger on page 22](#)
- [Using the CY8CKIT-002 MiniProg3 Programmer and Debugger on page 23](#)

4.3.1.5 Arduino Compatible Headers (J1, J2, J3, J4, and J12)

This kit has five Arduino compatible headers: J1, J2, J3, J4, and J12. You can develop applications based on the Arduino shield's hardware. An Arduino shield compatible Trackpad board is also supplied with the kit.

Figure 4-8. Arduino Header



Note: The graphic LCD shield in [Figure 4-8](#) is shown for reference only and not part of the kit.

- The J1 header contains I/O pins for reset and power supply line.
- The J2 header is an analog port. Because of limited analog support in PSoC 4000 family, it contains general-purpose digital I/O pins only.
- The J3 header is primarily a digital port. It contains I/O pins for PWM, I²C and general-purpose digital.
- The J4 header is also a digital port.
- The J12 header is an Arduino ICSP compatible header for the SPI interface. This header is not populated. Refer to the "No Load Components" section of Bill of Materials for the header part number.

Note: The PSoC 4000 family does not support SPI in hardware, but SPI master can be implemented on any pin using firmware bit banging.

Figure 4-9. Arduino Compatible Headers

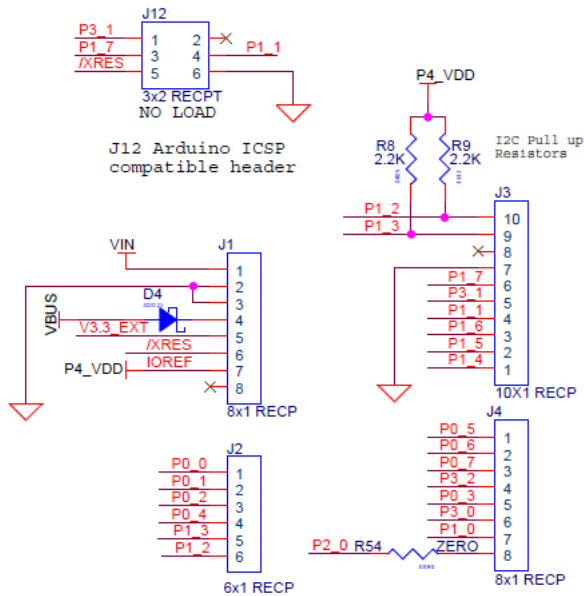
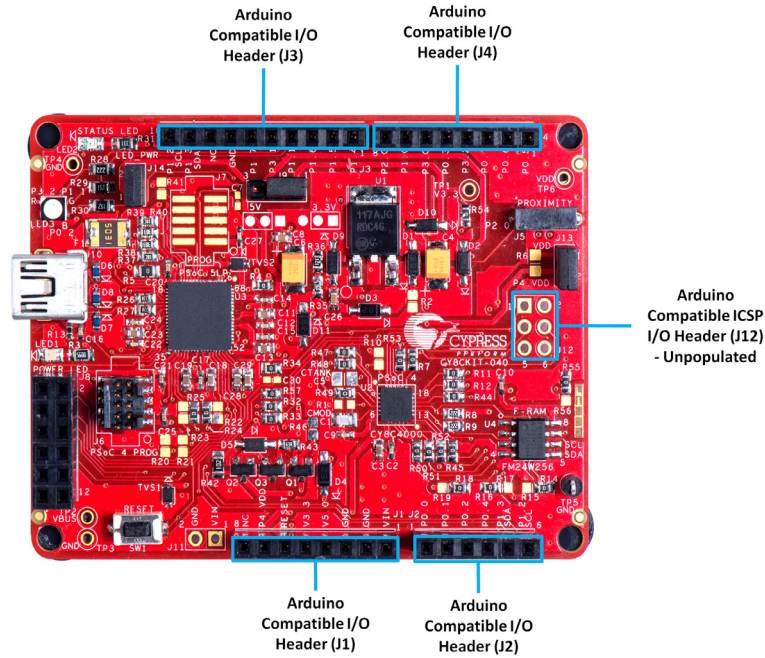

(J1-J4) Arduino Compatible Headers

Functionality of Unpopulated Header J12

The J12 header is a 2x3 header that supports Arduino shields. This header is used on a small subset of shields and is unpopulated on the PSoC 4000 Pioneer Kit.

Note: The J12 header functions only in 5 V mode. For proper shield functionality, ensure the power jumper (J9) is connected in 5 V mode.

4.3.1.6 PSoC 5LP GPIO Header (J8)

A limited set of PSoC 5LP pins are brought to this header. Refer to [Developing Applications for PSoC 5LP on page 133](#) for details on how to develop custom applications. See [Pin Assignment Table on page 166](#) for pin details.

Figure 4-10. PSoC 5LP GPIO Header (J8)

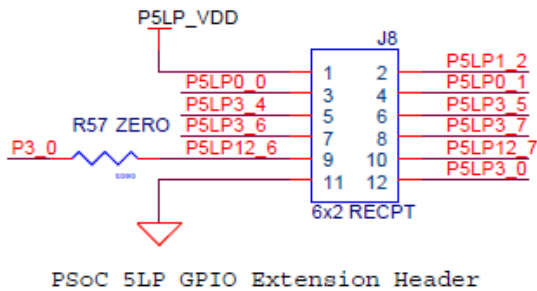
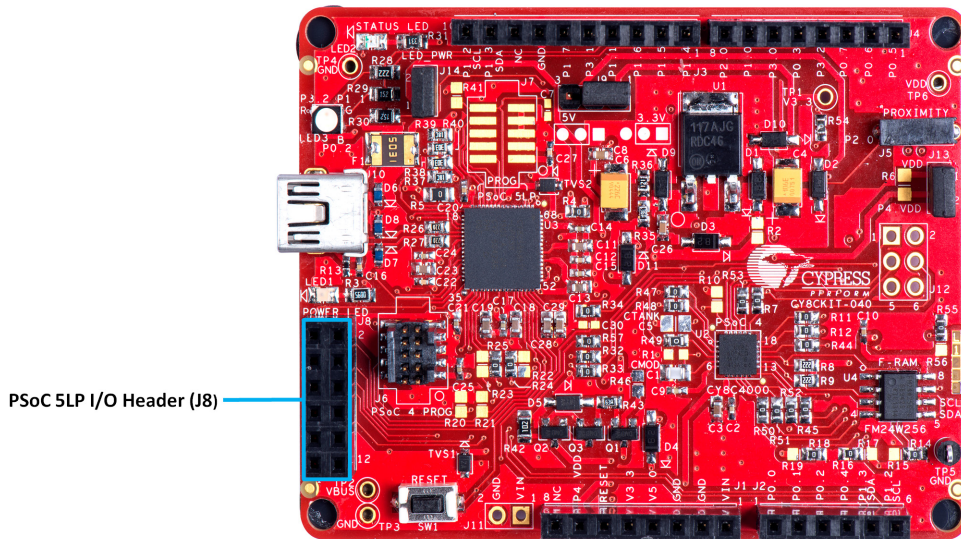

4.3.1.7 CapSense Circuit

The baseboard contains a header (J5) for CapSense proximity wire connection (see Figure 4-12). A 2.2-nF capacitor (C1) is present on CMOD pin, P0[4], for CapSense operation. An optional resistor R1 can be loaded to convert the current output from IDAC to a voltage output in non-CapSense applications.

The board optionally supports CapSense designs that require waterproofing. Any pin that supports CapSense in the device can be configured as a shield signal to enable waterproof operation. However, if a shield tank capacitor is required in the design, Capacitor C5 (CTANK) on the board needs to be populated with the desired tank capacitor value and R30 connecting the Blue LED to P0_2 needs to be removed. Refer to the [CapSense Design Guide](#) for further details related to CapSense.

Note: The kit does not demonstrate the waterproof feature using the Trackpad shield board that ships with the kit because of limited I/O availability after Trackpad and RGB LED implementation. However, a custom shield board can be designed to use the feature.

Figure 4-11. Baseboard CapSense Circuitry

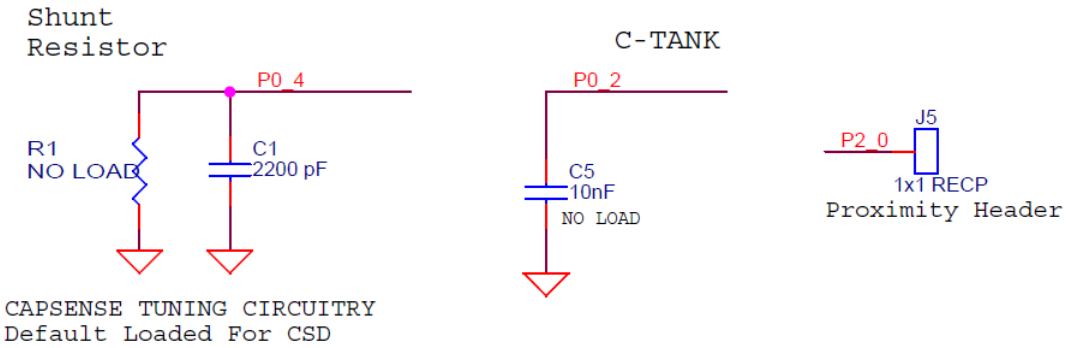
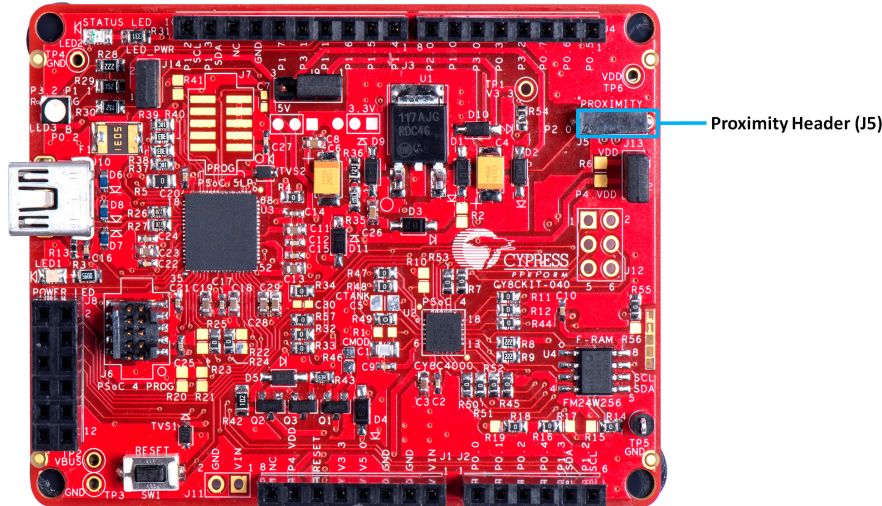

Figure 4-12. Proximity Header (J5)



4.3.1.8 Board LEDs

The PSoC 4000 Pioneer Kit board has three LEDs. A green LED (LED2) indicates the status of the programmer. See [KitProg Status LED States on page 170](#) for a detailed list of LED indications. An amber LED (LED1) indicates the status of power supplied to the board. The kit also has a general-purpose tricolor (RGB) LED (LED3) for user applications that connect to specific PSoC 4 pins. Jumper J14 is provided to enable/disable power to the RGB LED (LED3). The RGB LED is powered from PSoC 4 VDD, so jumper J14 needs to be removed to measure PSoC 4 power accurately without leakage and LED power.

[Figure 4-13](#) shows the indication of all these LEDs on the board. [Figure 4-14](#) and [Figure 4-15](#) detail the LED schematic.

Figure 4-13. Board LEDs

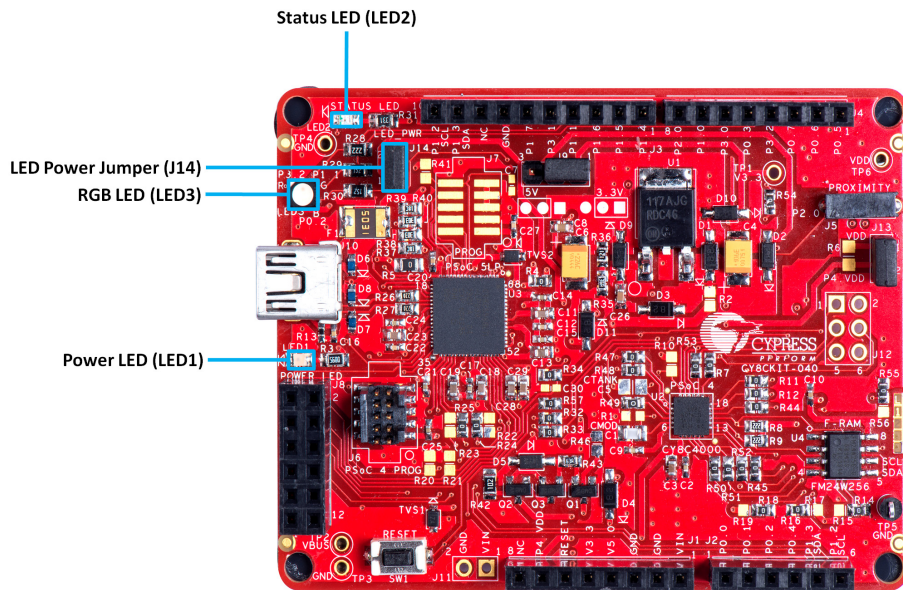

Figure 4-14. Power LED

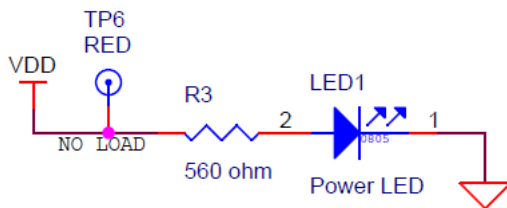
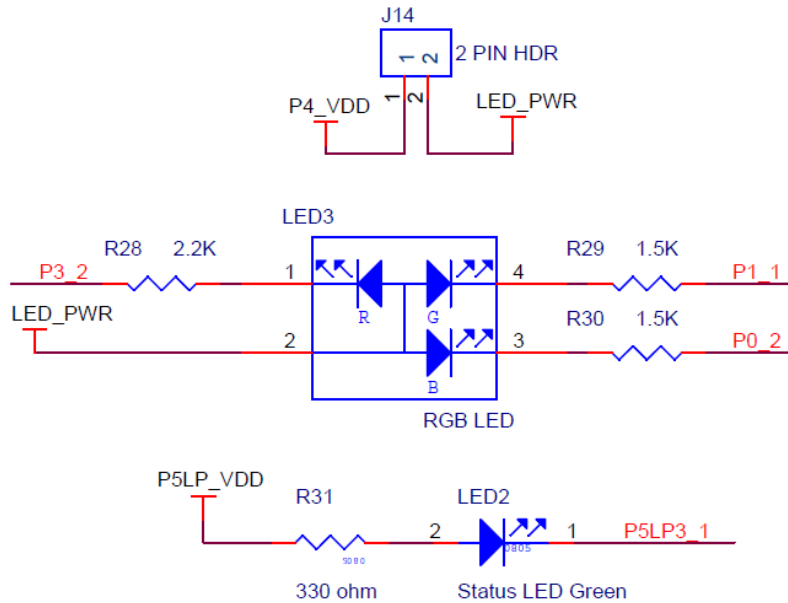

Figure 4-15. Status LED and RGB LED



4.3.1.9 Push Buttons

The kit contains only a Reset push button, as shown in Figure 4-16. The Reset button is connected to the XRES pin of PSoC 4 and is used to reset the onboard PSoC 4 device. The push button connects to ground on activation (active low).

Figure 4-16. Reset Push Button

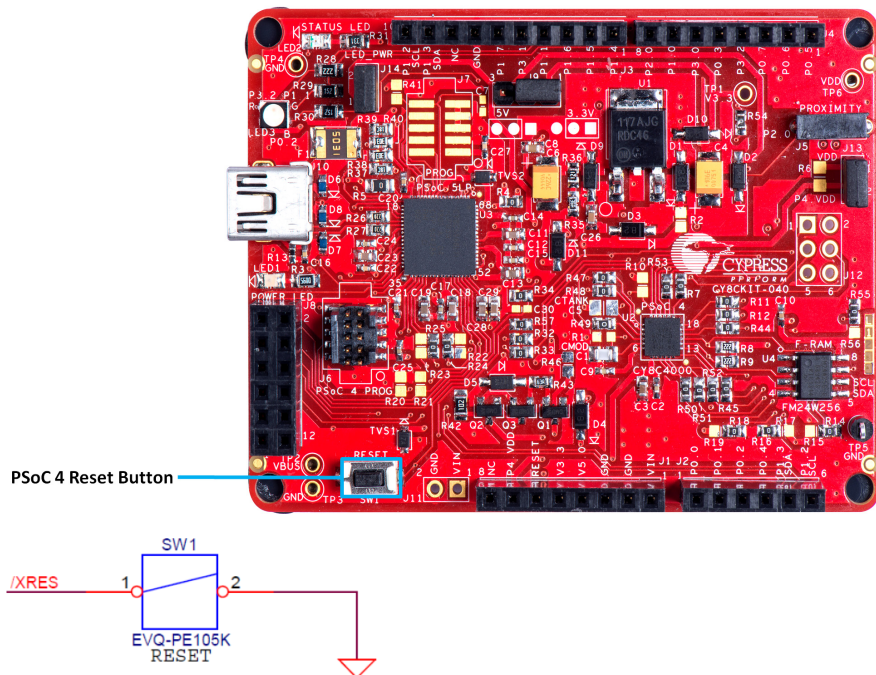

4.3.1.10 Cypress Ferroelectric RAM (F-RAM)

The baseboard contains an F-RAM device (FM24W256); see [Figure 4-17](#), which can be accessed through I²C lines by either of the PSoC devices – PSoC 5 LP or PSoC 4 – or by both. The F-RAM is 256 Kb (32 KB) in size with the I²C speed up to 1 Mbps. The I²C slave address of the F-RAM device is 7-bit wide, and the LSB three bits are configurable through physical pins and are hardwired to 000 on the board. By default, the address of the F-RAM device used on the board is 0x50. This can be modified by changing the R19/R18, R17/R16, and R15/R14 pairs. Refer to [Use of Zero-ohm Resistors and No Load on page 169](#) for details on how to change the F-RAM address using these resistors. The [Using FM24W256 F-RAM on page 115](#) provides an example implementation showing how to use this F-RAM device with PSoC 4 and share it between Bridge Control Panel over the PSoC 5LP USB-I²C bridge.

Figure 4-17. Cypress F-RAM

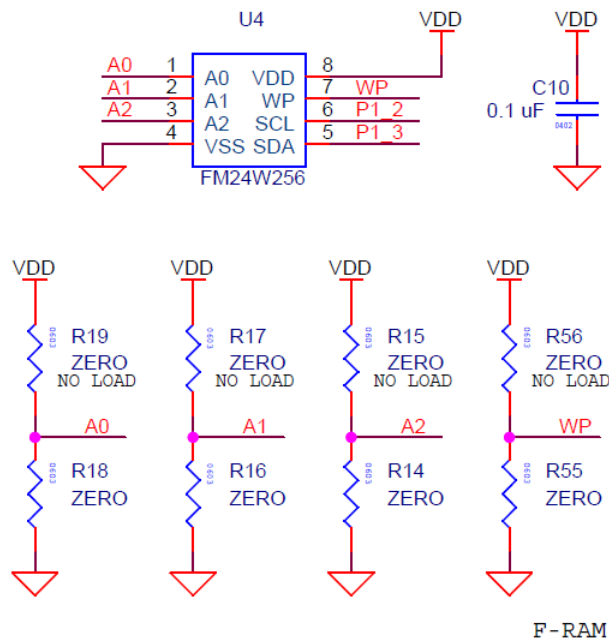
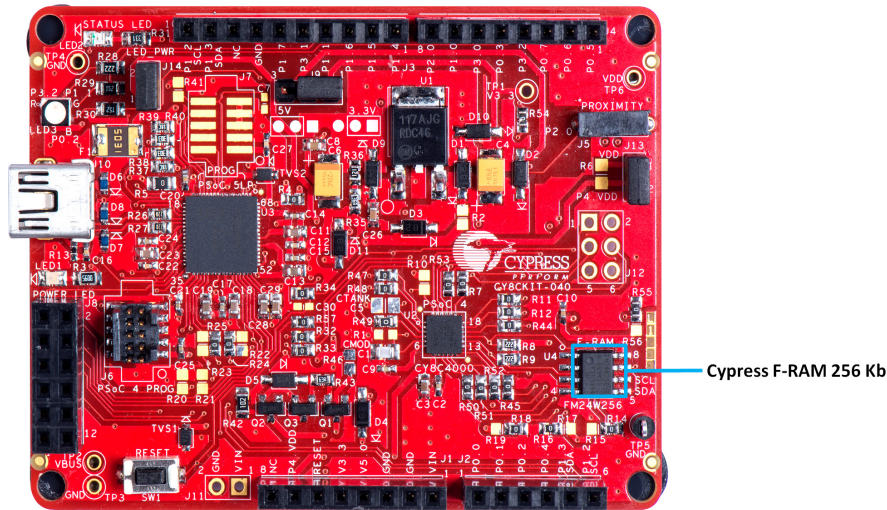

4.3.2 CY8CKIT-040 CapSense Trackpad Shield Board

The kit also includes an Arduino-compatible CapSense Trackpad shield board. The Trackpad in the kit is a 6x5 elements capacitive sensing array. [Figure 4-18](#) shows the pin mapping of the Trackpad.

The modulation capacitor (Cmod) used for CapSense is connected to pin P0[4], and an optional bleeder resistor (R1) can be connected across the Cmod. The Trackpad shield is Arduino-compatible and can also be used with the PSoC 4 Pioneer Kit (CY8CKIT-042). The sticker on the Trackpad shield can be redesigned according to user requirement and can be pasted on top of the Trackpad to implement any custom, application-specific UI. The [Trackpad/Touchpad Sticker Details on page 174](#) provides the sticker template.

Refer to the [CapSense Design Guide](#) for further details related to CapSense.

Figure 4-18. CapSense Trackpad Shield Board

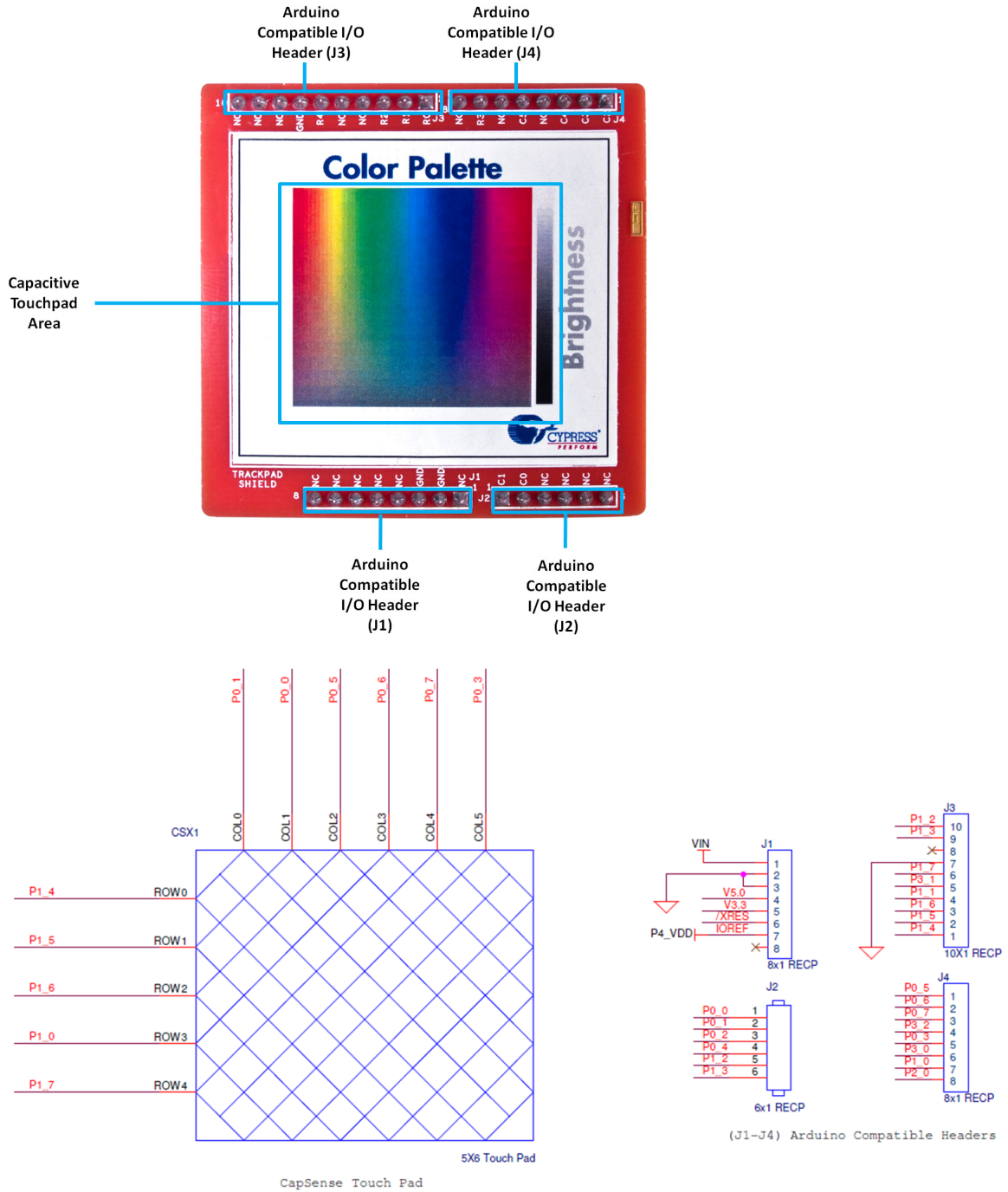

5. Code Examples



5.1 Overview

The example projects described in this chapter introduce the functionality of the PSoC 4000 device and the onboard components. To access the examples, download and install the CD ISO image or setup files from the kit web page as explained in [Install Software on page 15](#). The example projects are available at `<Install_Directory>\CY8CKIT-040 PSoC 4000 Pioneer Kit\<version>\Firmware\` after installation.

For more code examples, visit the [PSoC 3, PSoC 4, and PSoC 5 code examples page](#). This web page lists all PSoC Creator code examples available across application notes, kits, and PSoC Creator.

5.1.1 Programming the Example Projects

This section is provided as a reference for programming any example project into PSoC 4 on the board. The description of example projects shipped with the kit is from [Project: Blinking LED on page 56](#). Follow these steps to open and program an example project:

1. Launch PSoC Creator from the Windows Start menu (**Start > All Programs > Cypress > PSoC Creator<version> > PSoC Creator<version>**).
2. Open the example project by clicking **<Project_name>.cywrk** below **Examples and Kits > Kits > CY8CKIT-040**, as shown in [Figure 5-1](#). *CY8CKIT_040_Blinking_LED.cywrk* is used as reference here.

Figure 5-1. Open Code Example from PSoC Creator

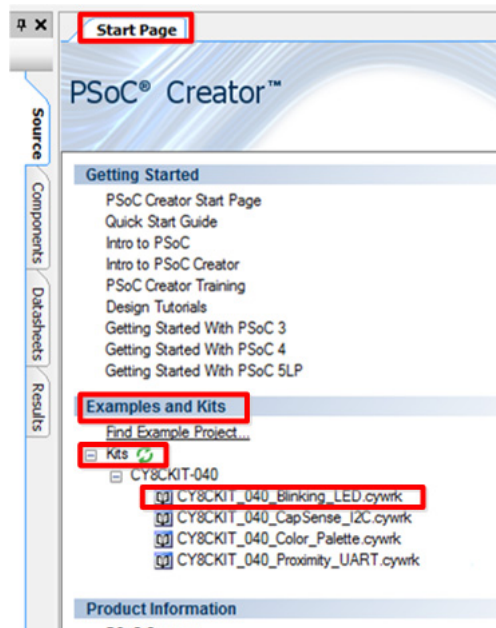

3. Build the code example by choosing **Build > Build CY8CKIT_040_Blinking_LED.cywrk** to generate the hex file, as shown in [Figure 5-2](#).

Figure 5-2. Build Project from PSoC Creator

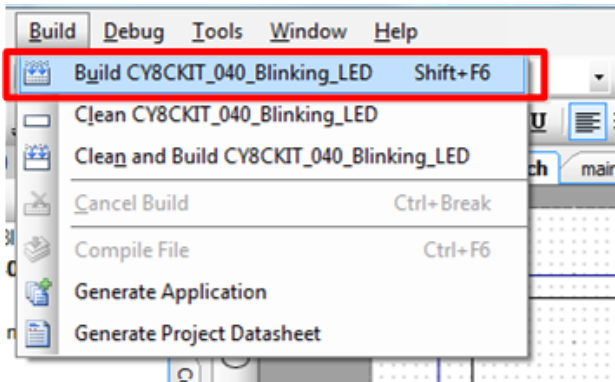

4. To program, connect the board to a computer using the USB cable connected to port J10, as described in [Kit USB Connection on page 21](#). The board is detected as KitProg.
5. Choose **Debug > Program** from PSoC Creator, as shown in [Figure 5-3](#).

Figure 5-3. Program Device from PSoC Creator

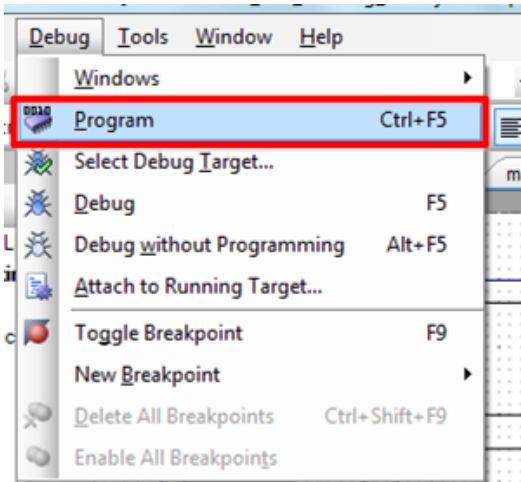

- If the device is not yet acquired, PSoC Creator will open the **Select Debug Target** window. Select **KitProg/<ID>** and click the **Port Acquire** button, as shown in [Figure 5-4](#).

Figure 5-4. Acquire Device from PSoC Creator

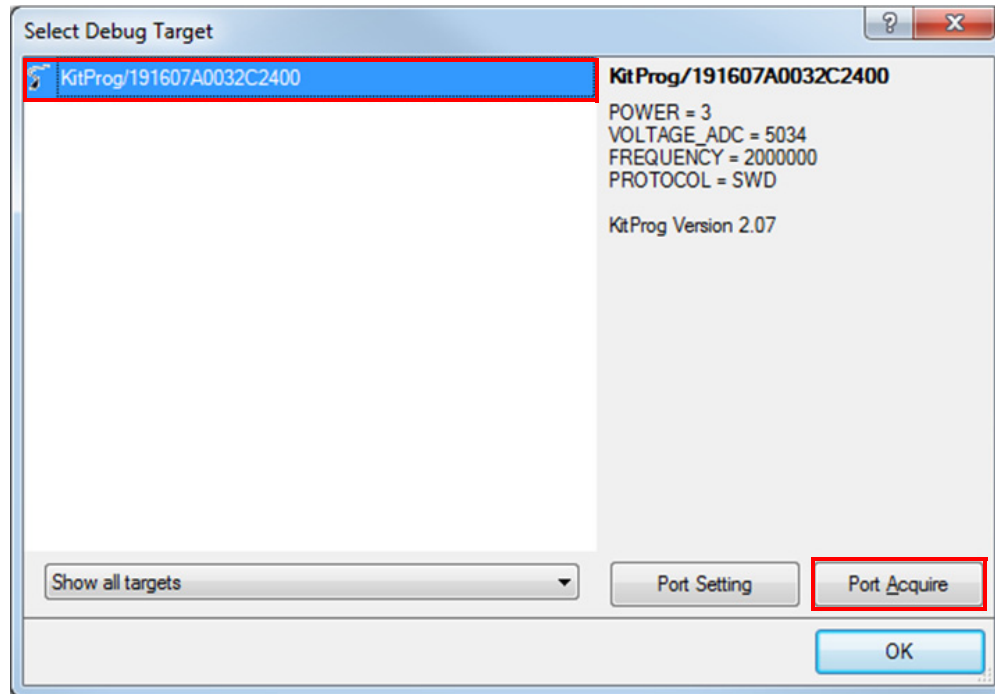

- After the device is acquired, it is listed in a tree structure below the KitProg (see [Figure 5-5](#)). Click the **Connect** button.

Figure 5-5. Connect Device from PSoC Creator

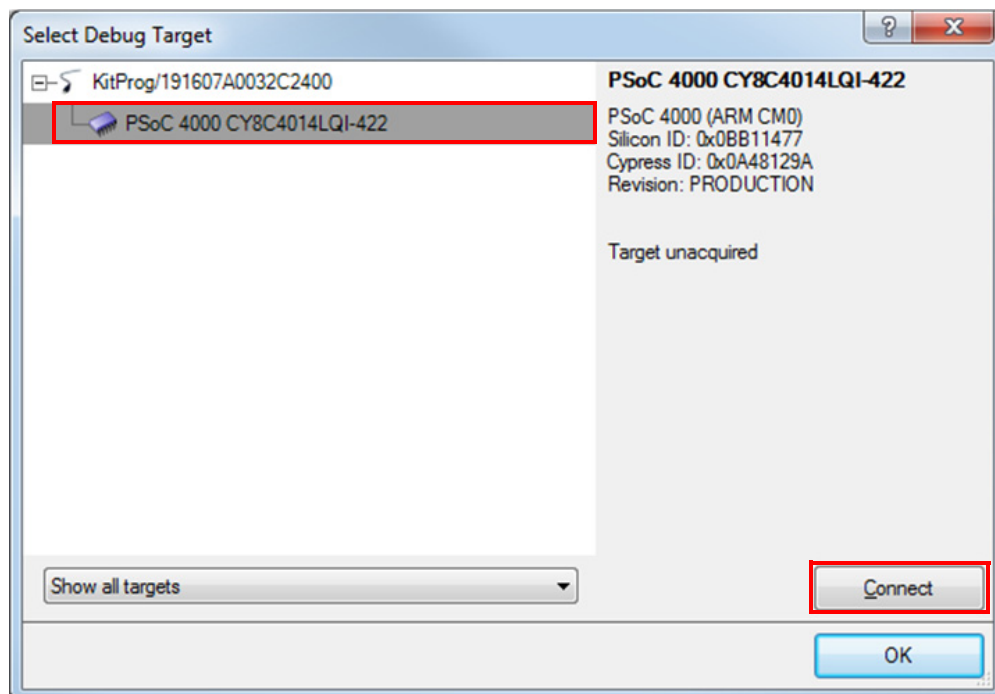

8. Click **OK** to exit the window and start programming, as shown in [Figure 5-6](#).

Figure 5-6. Program Device from PSoC Creator

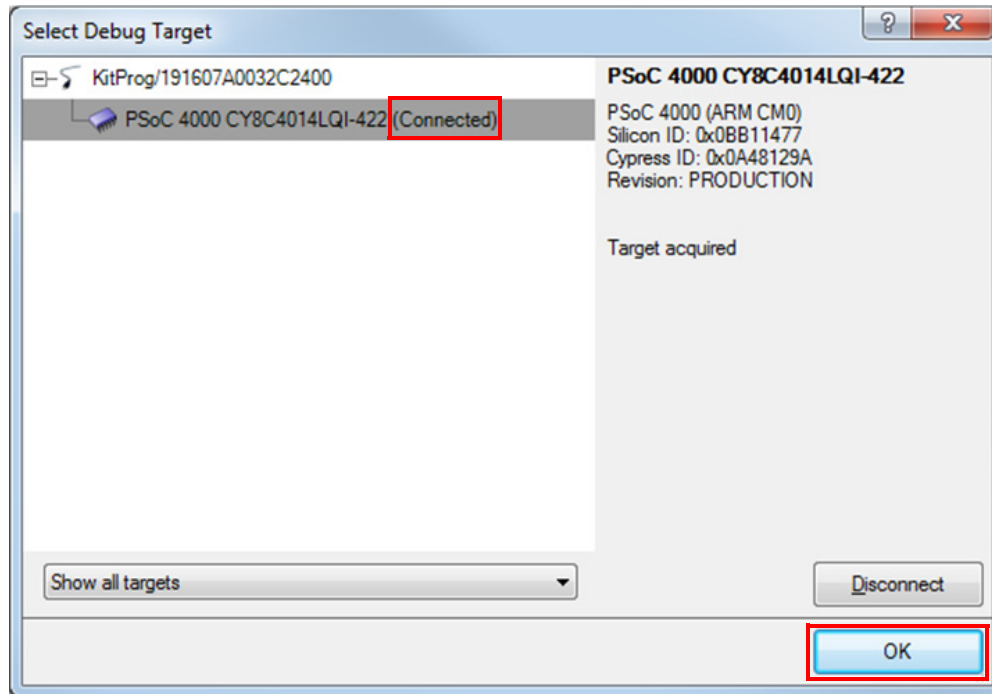

Notes:

- The Debug port is disabled by default in one of the example projects ([Project: CapSense Proximity and UART on page 59](#)) because it uses the P3[0] (SWDIO) pin for software TX output. If debug is required, then change the **Debug Select** setting in the *cydwr* file to SWD, as shown in [Figure 5-8](#). and disable software TX in the project by commenting out the TX_ENABLE macro present in the *main.h* file. The example project, [Project: Color Palette on page 86](#), includes a software TX, but the TX port is disabled by default. To enable the TX port, change the **Debug Select** setting in the *cydwr* file to **GPIO** and uncomment the TX_ENABLE macro in the *main.h* file. If TX is required along with SWD debug, then follow these steps:
 - a. Route TX pin to any other available pin by modifying TX_PORT/TX_PIN macro available in main.h file of the projects.
 - b. Remove resistor R57 ([Figure 5-7](#)) on the board.
 - c. Route the TX pin selected in step 1 to pin J8_9 (P12[6]/RX line of PSoC 5LP available in J8).
- Reset the device after plugging in the USB cable for the first time (if kit drivers are installing, then after driver installation) when using SmartSense Auto-tuning in the project. This is because SmartSense tunes the sensors during power-on and the presence of hand or power fluctuations during the USB plugging will affect the tuning algorithm; it can render stuck or insensitive touch sensors.
- By default, when the example projects are opened for the first time, an inline error can pop up in the *main.c* or *main.h* file against the '#include <project.h>' line. This error is temporary and will go off when the project is built. The *project.h* file is generated only when the project is built, hence the error is shown before building the project.

Figure 5-7. R57 Location on the Board

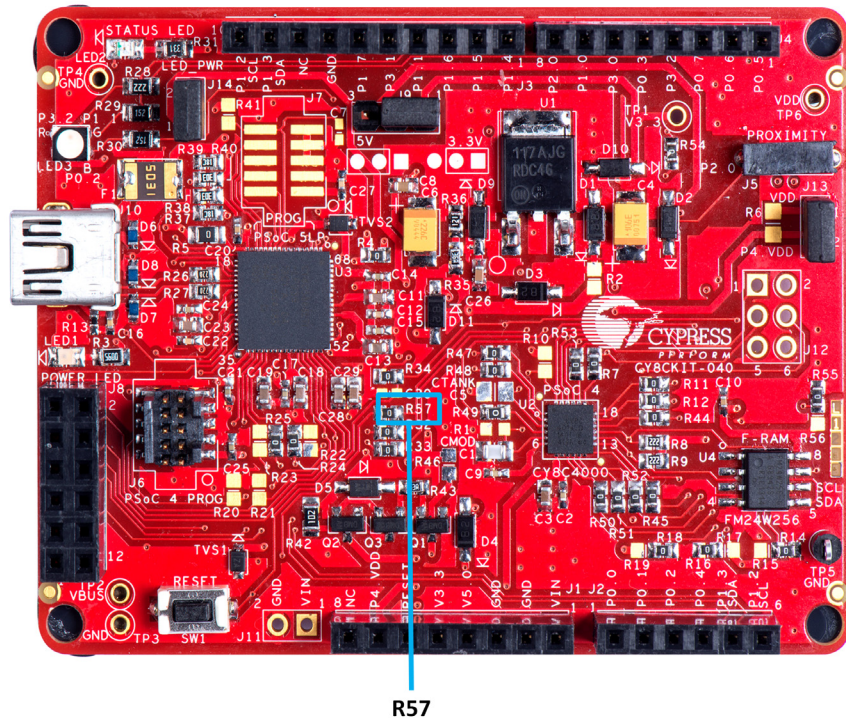
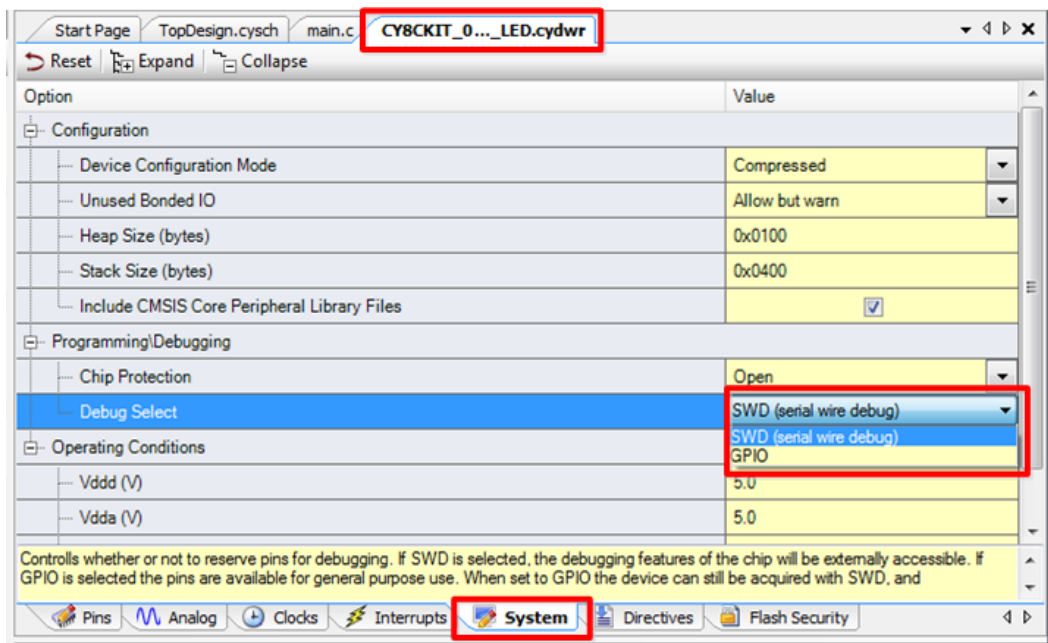

Figure 5-8. Debug Port Pin Functionality Selection



5.2 Project: Blinking LED

5.2.1 Project Overview

The *CY8CKIT_040_Blinking_LED.cypri* example uses a PWM block to blink the red LED of the RGB LED, as shown in Figure 5-9. The PWM output is connected to pin P3_2 (red) of the RGB LED. The PWM block is configured as a digital clock signal generator with a frequency of 1 Hz. The blinking rate can be varied by changing the period and compare value of the PWM.

Figure 5-9. PSoC Creator Schematic Design of Blinking LED Project

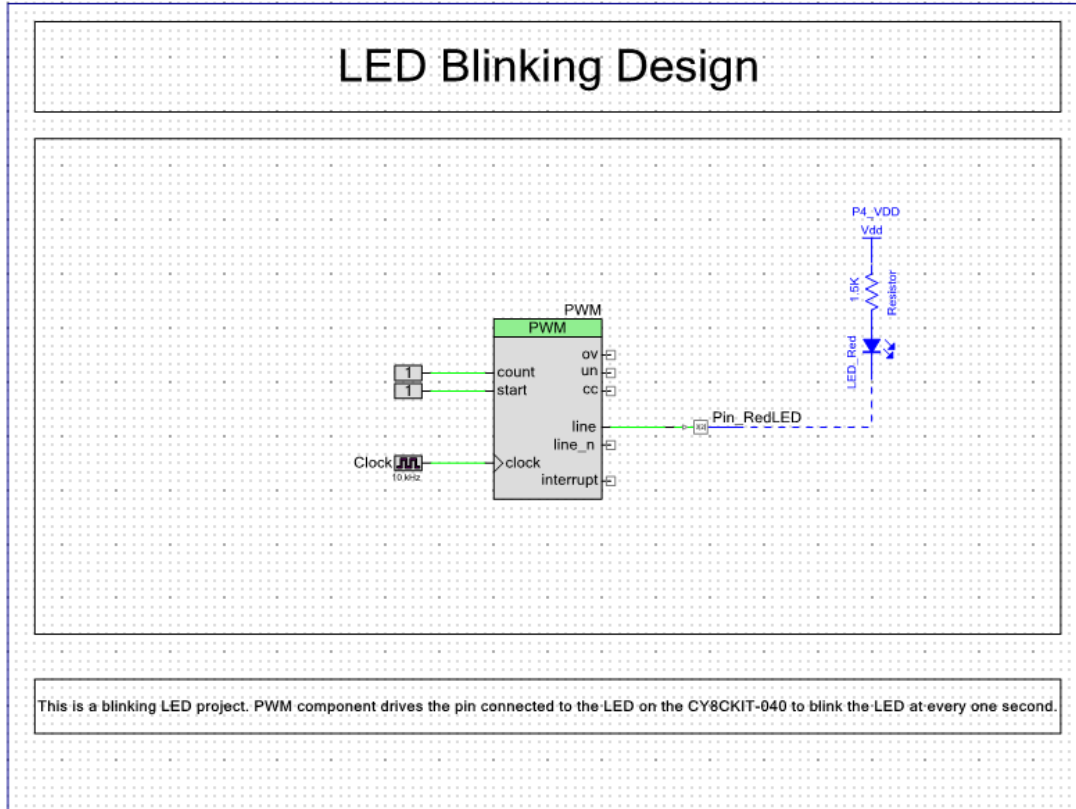

5.2.2 Project Description

5.2.2.1 PSoC Creator Component Configuration

PWM (TCPWM mode)

The TCPWM Component is configured as a PWM with the parameters shown in [Figure 5-10](#).

Figure 5-10. TCPWM Component Parameters

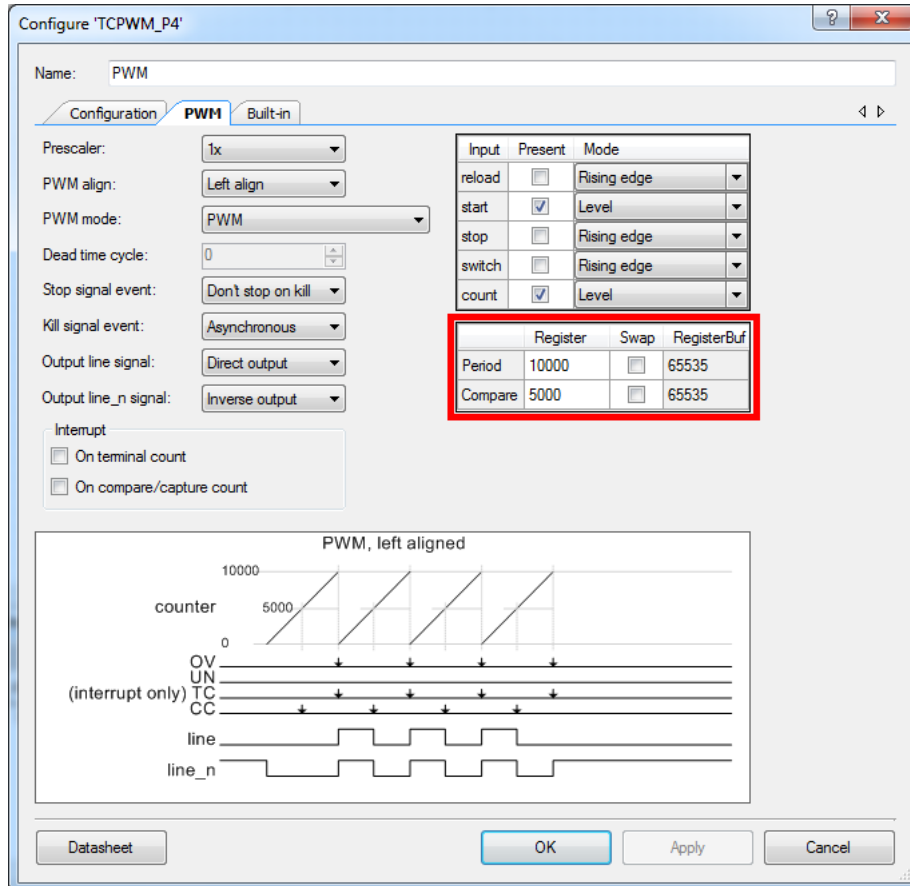

The screenshot shows the 'Configure TCPWM_P4' dialog box. The 'Name' field is set to 'PWM'. The 'Configuration' tab is selected. The 'Prescaler' is set to '1x', 'PWM align' to 'Left align', and 'PWM mode' to 'PWM'. The 'Dead time cycle' is 0. The 'Stop signal event' is 'Don't stop on kill', 'Kill signal event' is 'Asynchronous', 'Output line signal' is 'Direct output', and 'Output line_n signal' is 'Inverse output'. The 'Interrupt' section has 'On terminal count' and 'On compare/capture count' checked.

Input	Present	Mode
reload	<input type="checkbox"/>	Rising edge
start	<input checked="" type="checkbox"/>	Level
stop	<input type="checkbox"/>	Rising edge
switch	<input type="checkbox"/>	Rising edge
count	<input checked="" type="checkbox"/>	Level

	Register	Swap	RegisterBuf
Period	10000	<input type="checkbox"/>	65535
Compare	5000	<input type="checkbox"/>	65535

The waveform diagram at the bottom shows a 'PWM, left aligned' signal. The counter ranges from 0 to 10000, with a period of 10000 and a compare value of 5000. The output signals 'line' and 'line_n' are shown as complementary square waves. The interrupt signals 'OV', 'UN', 'TC', and 'CC' are also shown.

5.2.2.2 Firmware Details

Figure 5-11 shows the flow chart of code implemented in main.c.

Figure 5-11. Blinking LED Project Flow Chart

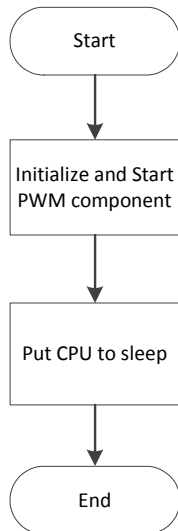

5.2.2.3 Hardware Connections

No specific hardware connections are required for this project because all connections are hard-wired on the board. Open *CY8CKIT_040_Blinking_LED.cydwr* under the **Source** vertical tab in the **Workspace Explorer** and select the suitable pin, as shown in Figure 5-12.

Table 5-1. Pin Connection

Pin Name	Port Name
PWM	P3_2 (Red)

Figure 5-12. Pin Selection for Blinking LED Project

Alias	Name /	Port	Pin
Pin_RedLED	P3[2] TCPWM:line_out		23

5.2.3 Verify Output

Build and program the code example onto the device. Observe the frequency and duty cycle of the blinking LED. Change the period and compare value in the PWM Component, as shown in Figure 5-10. Rebuild and reprogram the device to change the blinking rate.

5.3 Project: CapSense Proximity and UART

5.3.1 Project Overview

The project *CY8CKIT_040_Proximity_UART.cypri* implements a capacitive proximity sensor controlling the brightness of a LED. The project configures the sensor as a CapSense proximity widget with SmartSense Auto-tuning. [Firmware Details on page 63](#) presents the firmware flow and explains the firmware blocks in detail.

Figure 5-13. PSoC Creator Schematic Design of PWM Project

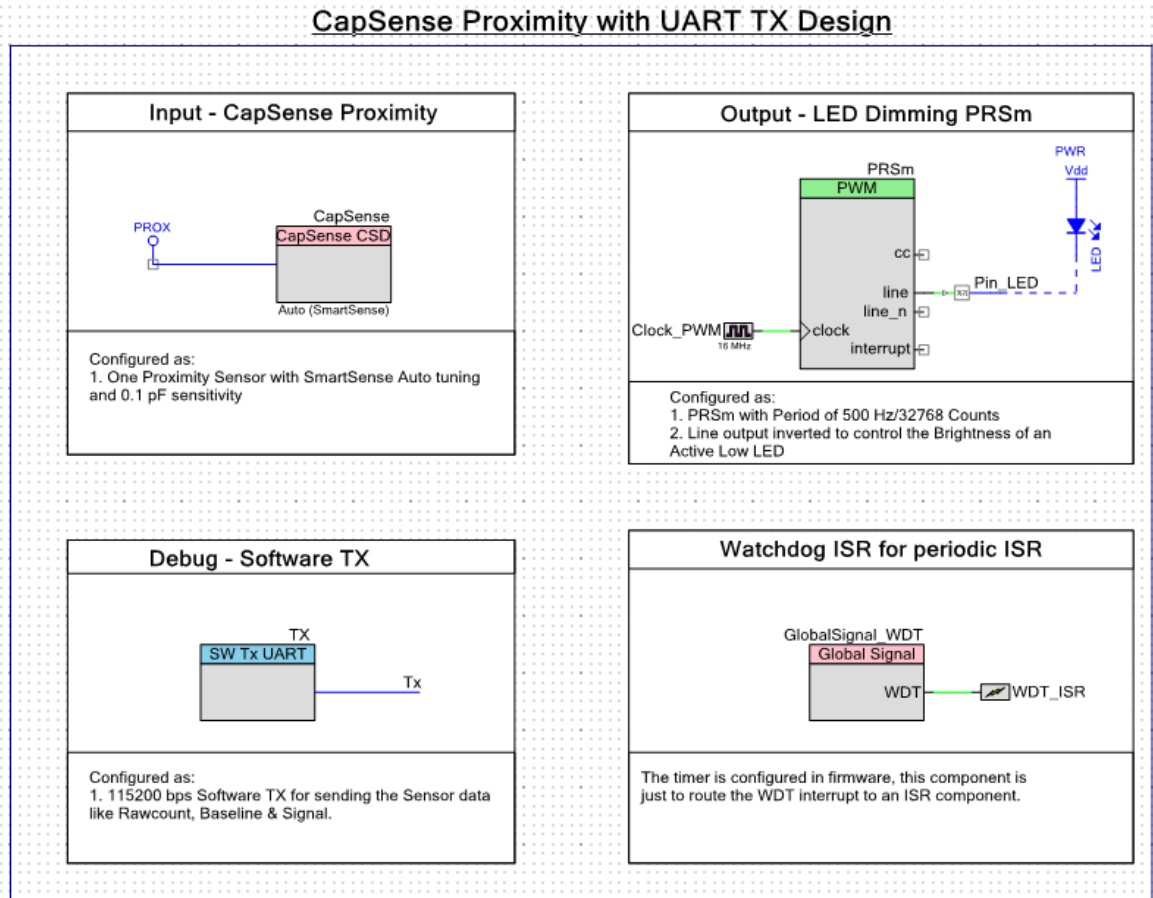

5.3.2 Project Description

5.3.2.1 PSoC Creator Component Configuration

CapSense

The CapSense Component is configured in SmartSense Auto-tuning mode with one proximity sensor for the design with the parameters shown in [Table 5-2](#).

Table 5-2. CapSense Component Parameters

Parameter	Tab Present	Value	Rationale
Tuning method	General	Auto (SmartSense)	Automatically adjust sensitivity for different system environments.
Threshold mode		Automatic	To enable run-time threshold calculation for 5:1 SNR
Raw data noise filter		First Order IIR 1/4	Filter out noise or unwanted spikes in raw count. This setting can be tweaked based on requirement.
ProximitySensor0	Widgets Config	-	Add a proximity sensor by clicking Proximity Sensors and then clicking Add Proximity Sensor . The only parameter that is available to modify in this tab is debounce. This can be set or adjusted based on system requirements.
Analog switch drive source	Advanced	PRS-12b	Reduce EMI emission and enhance EMC immunity.
Sensor auto-reset		Disabled	Not required in the design. Add if required by the application.
Low baseline reset		5	System dependent number. Configure according to user needs.
Inactive sensor connection		Ground	Make the proximity loop not pick up any charge when not scanned
Shield		Disabled	Not used in the design.
Guard sensor		Disabled	Not used in the design.
Cmod precharge		Precharge by Vref buffer	Vref is enough for precharging, as there is only one sensor. Cmod voltage will not drop too low for a fast GPIO precharge.
Sensitivity	Scan Order	1	Obtain the maximum possible sensitivity using SmartSense. The parameter controls the scan time, so for a lower number sensitivity setting, the scan rate will be higher. This parameter can be adjusted depending on the response rate and proximity range needed.
Enable Tuner helper	Tuner helper	Unchecked	No tuner used.

PRSm (TCPWM Mode)

The TCPWM Component is used to control the LED brightness. The CapSense proximity sensor's signal output is used to deduce the LED brightness. [Figure 5-14](#) shows the parameters for the TCPWM Component. The TCPWM block is configured as a PWM in Pseudo Random Sequence modulator (PRSm) mode with a resolution of 15 bits (fixed by the TCPWM block architecture). This 15-bit resolution of the PRSm along with a 16-MHz input clock generates a period of 500 Hz (PRS repeat period). The output line is inverted to drive the Active Low LED. A period of 32767 is set in the

Component to generate the proper period macro for the 15-bit PRSm. Though the output of PRSm has a variable frequency with a maximum frequency of 8 MHz (16 MHz/2), the repeat rate of PRSm is considered to be the period in this context.

Note: The Compare value should be a minimum of '1'; '0' will leave the LED on.

Figure 5-14. TCPWM Component Configuration - 'PWM' Tab

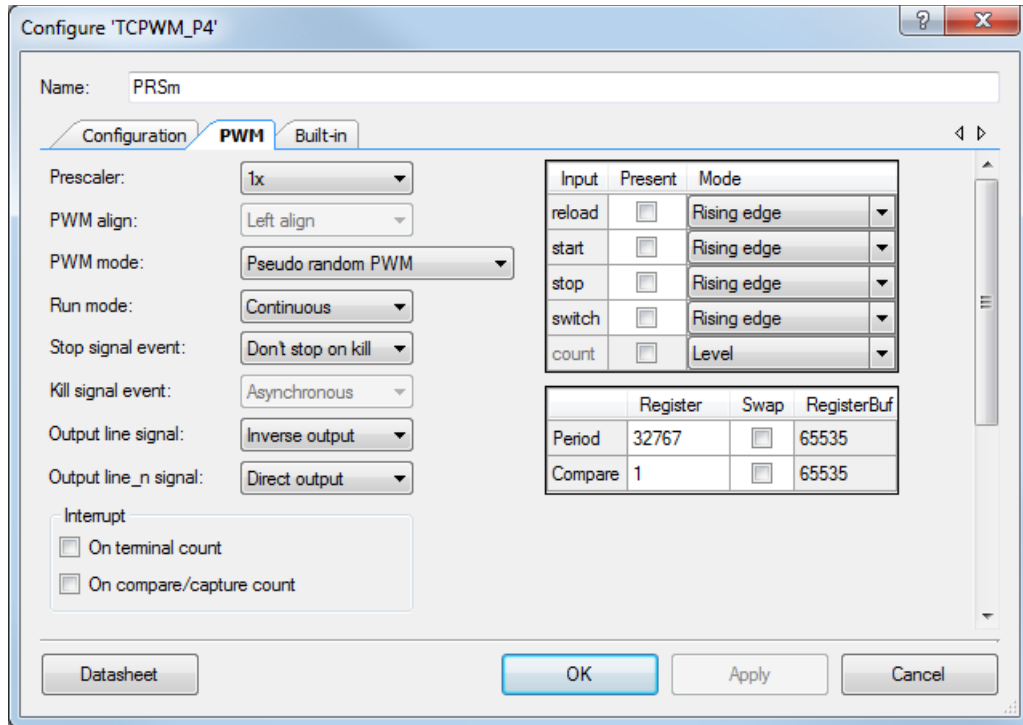

TX (Software TX UART)

The software transmit TX is used to send out proximity sensor related data for debugging. The configuration for the component is shown in [Figure 5-15](#). The TX pin is selected in firmware through TX_PORT/TX_PIN macros defined in the *main.h* file. The SW TX data can be sent to the PC using either an RS232 connector (with a voltage level translator in between) or through the USB-UART bridge available in the CY8CKIT-040 PSoC 5 LP UART bridge, or the CY3240 bridge configured as a UART bridge as documented in [AN2397](#).

Figure 5-15. Software UART TX Component Parameters

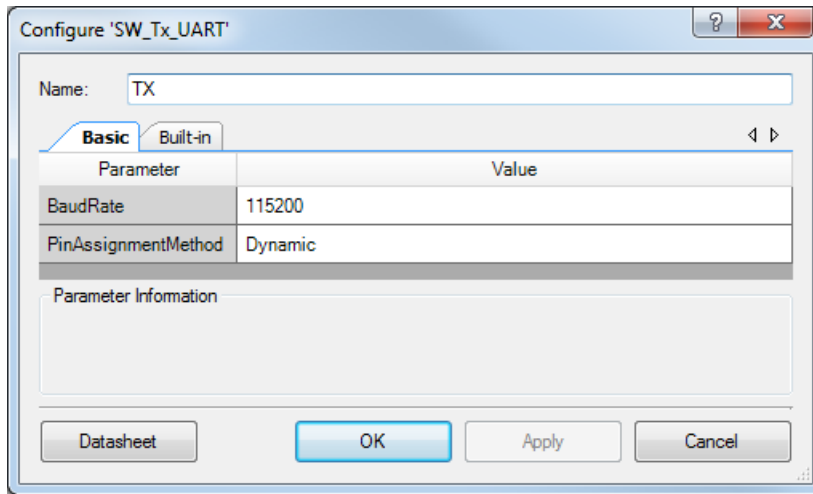

Pin_LED (Digital Output Pin)

The digital output pin is used to drive the PWM output to the LED. It is a standard strong drive output pin.

Clock_PWM (Cy_Clock)

Clock_PWM provides the clock that drives the PWM block. The clock is configured to be the maximum possible or allowed (16 MHz), so that the repeat rate of the PRSm is as high as possible for reduced LED flickers.

GlobalSignal_WDT (Global Signal Reference with ISR)

Component used to route the WDT ISR to an ISR component. This ISR is then configured in firmware for generating periodic wakeup signal using WDT during Sleep_Scan mode.

5.3.2.2 Firmware Details

Firmware Structure

The firmware is written in a modular format, with different aspects of the functionality provided as separate functions for easy understanding. The header provides a list of handy macros for configuring the project's key aspects according to user requirements. The comments in the header file provide the details on the macro.

Table 5-3. Source Files and Header Files in the CapSense Proximity Project

File Names	Purpose
main.c	This file contains all the function definitions used in the firmware.
main.h	This file contains all the macros used in the firmware. The details of the macros and their usage can be found in the comments above each macro.

Firmware Flow Chart

Figure 5-16 shows the flow chart of code implemented in main.c.

Figure 5-16. CapSense Proximity and UART Project Flow Chart

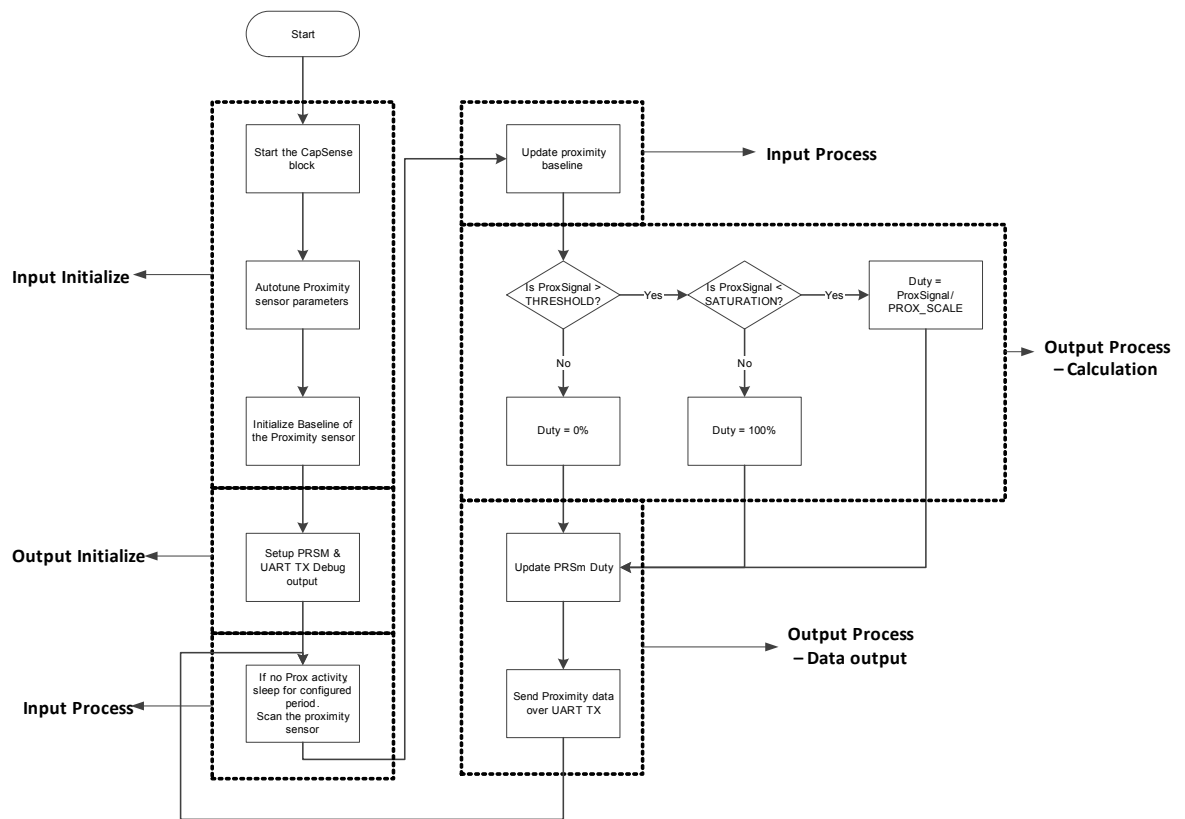

The firmware does the following:

- The CapSense/input initialization part tunes the CapSense system parameters using SmartSense.
- The output initialization part configures the PWM and the software UART TX output.
- The infinite loop code is divided into two phases: input process and output process.
 - The input process phase scans the proximity sensor and processes the sensor signal, such as applying filter, calculating baseline, and signal.
 - The output process phase is also split into two phases: the data calculation and data output subphases.
 - i. The data calculation subphase compares the proximity signal with a minimum and maximum threshold defined for an approaching hand. The LED brightness is then calculated based on the sensor's signal value relative to the thresholds. The minimum threshold generates the lowest LED brightness, and the maximum threshold generates the highest LED brightness.
 - ii. The data output subphase updates the PWM compare value with the calculated brightness. The system data such as sensor raw data, baseline, signal, and calculated LED brightness are sent over the UART TX line.

The device monitors the activity on the proximity sensor, and if there is no activity, that is, if the hand is out of range of the proximity, then the device enters a sleep-scan mode. The time for which the device checks for a no activity on the sensor before entering sleep-scan mode is set to 5 seconds and is configurable in the project (ENTER_SLEEP_COUNTS macro in *main.h*). In the sleep-scan mode, the device wakes up every 100 ms and checks for any activity on the proximity sensor. This wakeup rate is configurable by modifying the WATCHDOG_TIMER_COUNT macro in the *main.h* file.

Note: There are macros defined in *main.h* for configuring the project based on user requirements. The details of each macro are mentioned in comments above its definition.

Useful CapSense Component Functions/Variables

[Table 5-4](#), [Table 5-5](#), and [Table 5-6](#) provide details of some useful variables, macro definitions, and component APIs respectively. These details are also available in the [CapSense component datasheet](#).

Note: All reference to the API/variable/macro assume the CapSense component instance name as 'CapSense'.

Table 5-4 provides a quick reference to some key CapSense component variables/arrays.

Table 5-4. CapSense Component Key Variables

Variable/Array Name	Description	Usage
uint16 CapSense_SensorRaw []	<p>This array contains the raw data for each sensor. The array size is equal to the total number of sensors (CapSense_TOTAL_SENSOR_COUNT). The CapSense_SensorRaw [] data is updated by these functions:</p> <ul style="list-style-type: none"> • CapSense_ScanSensor() • CapSense_ScanEnabledWidgets() • CapSense_InitializeSensorBaseline() • CapSense_InitializeAllBaselines() • CapSense_UpdateEnabledBaselines() 	<p>The variable can be accessed in any file by importing it using 'extern uint16 CapSense_SensorRaw[];' in the '.c' or '.h' file.</p> <p>It is recommended not to alter the arrays manually.</p>
uint16 CapSense_SensorBaseline[]	<p>This array holds the baseline data of each sensor. The historical count value, calculated independently for each sensor is called the sensor's baseline. The array's size is equal to the total number of sensors. The CapSense_SensorBaseline[] array is updated by these functions:</p> <ul style="list-style-type: none"> • CapSense_InitializeSensorBaseline() • CapSense_InitializeAllBaselines() • CapSense_UpdateSensorBaseline() • CapSense_UpdateEnabledBaselines(). 	<p>The variable can be accessed in any file by importing it using 'extern uint16 CapSense_SensorBaseline[];' in the '.c' or '.h' file.</p> <p>It is recommended not to alter the arrays manually.</p>
uint8 CapSense_SensorSignal[]	<p>This array holds the sensor signal count computed by subtracting the previous baseline from the current raw count of each sensor. Each array element corresponding to a sensor will have the difference value only if the value is above the noise threshold of the sensor. Otherwise, it will be 0. The array size is equal to the total number of sensors. The CapSense_SensorSignal[] array is updated by these functions:</p> <ul style="list-style-type: none"> • CapSense_InitializeSensorBaseline() • CapSense_InitializeAllBaselines() • CapSense_UpdateSensorBaseline() • CapSense_UpdateEnabledBaselines(). 	<p>The variable can be accessed in any file by importing it using 'extern uint8 CapSense_SensorSignal[];' in the '.c' or '.h' file.</p> <p>It is recommended not to alter the arrays manually.</p>

Table 5-5 provides a quick reference to some key CapSense component macro definitions.

Table 5-5. CapSense Component Macros

Macro Format	Sample	Description
CapSense_TOTAL_SENS OR_COUNT	_	Defines the total number of sensors within the CapSense component.
CapSense_SENSOR_"WI DGET_NAME"<ELE- MENT+ELEMENT_NUMB ER>_"WIDGET_TYPE"	<ul style="list-style-type: none"> • CapSense_SENSOR_TP1_ROW0__TP • CapSense_SENSOR_LS0_E0__LS • CapSense_Sensor_BTN1__BTN 	<p>The constant denotes the sensor number of a sensor in the CapSense block.</p> <p>WIDGET_TYPE:</p> <p>BTN – buttons LS – linear sliders RS – radial sliders TP – touchpads PROX – proximity sensors MB – matrix buttons GEN – generic sensors GRD – guard sensors</p>
CapSense_"WIDGET_NA ME"_"WIDGET_TYPE"	<ul style="list-style-type: none"> • CapSense_TP1__TP • CapSense_LS0__LS • CapSense_BTN1__BTN 	The constant denotes the widget number of a widget in the CapSense block.

Table 5-6 provides a quick reference to some key CapSense component APIs and their usage.

Table 5-6. CapSense Component APIs

API	Description/Usage
void CapSense_EnableWidget(uint32 widget)	<p>The API enables the selected widget sensors to be part of the scanning process.</p> <p>Proximity widgets are disabled by default in the component; the user needs to call this API along with the proximity widget number to enable the same to be included in the scanning process.</p>
void CapSense_Start(void)	<p>The API enables the CapSense block and tunes the sensors if SmartSense or Auto-calibration is used.</p> <p>It should be called before using the CapSense block for sensing.</p>
void CapSense_InitializeAllBaselines(voi d)	<p>The API initializes the CapSense_sensorBaseline[] array with values obtained by scanning all sensors.</p> <p>It should be called after starting the CapSense block and before starting the scan for detecting touches.</p>
void CapSense_InitializeSensorBaseline (uint32 sensor)	<p>The API initializes the CapSense_sensorBaseline[sensor] array element with values obtained by scanning the selected sensor.</p> <p>It can be used initialize each baseline individually.</p>
void CapSense_ScanEnabledWidgets(v oid)	<p>The API starts scanning a sensor within the enabled widgets. The ISR continues scanning sensors until all enabled widgets are scanned. Use of the ISR ensures this function is non-blocking. After each sensor scan is complete, the ISR copies the measured sensor raw data to the CapSense_SensorRaw[] array.</p> <p>This is the preferred scanning method if there are multiple widgets in the design.</p>

Table 5-6. CapSense Component APIs

API	Description/Usage
void CapSense_ScanWidget(uint32 widget)	The API sets the CapSense block settings for the selected widget and starts scanning the widget. It can be used if scanning of only an individual widget is desired.
void CapSense_ScanSensor(uint32 sensor)	The API scans the selected sensor. After scanning is complete, the ISR copies the measured sensor raw data to the CapSense_SensorRaw[sensor] array element. It can be used to perform individual sensor scanning.
uint32 CapSense_IsBusy(void)	The API returns the status of sensor scanning. After calling any of the scan APIs, this API can be used to check whether the triggered scan is complete. Returns '1' if scan is in progress '0' if scan is complete
void CapSense_UpdateSensorBaseline(uint32 sensor)	The API filters the CapSense_SensorRaw[sensor] element using the filter selected in the component. It updates the CapSense_SensorBaseline[sensor] element using a low-pass filter with k = 256 on the filtered CapSense_SensorRaw[sensor] value. This API should be called after completion of the ScanSensor() API, before checking for any activity on the sensor.
void CapSense_UpdateEnabledBaselines(void)	The API applies selected filter to the CapSense_SensorRaw[] array and updates the CapSense_SensorBaseline[] array of all the sensors present in the enabled widgets. This API should be called after the completion of the ScanEnabledWidgets() API before checking for any activity on any of the sensors.
uint32 CapSense_CheckIsWidgetActive(uint32 widget)	The API compares the selected sensor CapSense_Signal[] array value to its finger threshold. Hysteresis and debounce are applied to determine if a sensor in the selected widget is active. This API should be called after the UpdateSensorBaseline() or UpdateEnabledBaselines() API to check if any sensor in the widget is active. Returns '1' if one or more sensors within the widget are active '0' if all sensors within the widget are inactive
uint32 CapSense_CheckIsAnyWidgetActive(void)	The API performs the same task as CapSense_CheckIsWidgetActive() on all the enabled widgets. This API should be called after the UpdateEnabledBaselines() API or after updating the baseline of all enabled sensors/widgets, to check if any of the sensors is active in all the enabled widgets. Returns '1' if any widget is active '0' if all the widgets are inactive

5.3.2.3 Hardware Connections

A wire in the form of a loop is connected to jumper J5 (P2_0), as shown in [Figure 5-17](#). To enable the UART TX connection to the PSoC 5LP USB-UART bridge, make sure R57 is populated on the board (by default it is populated on the board). No other hardware connections are required for this project. All other connections are hardwired on the board.

Note: The proximity distance depends on the diameter of the wire loop. The larger the diameter, the greater the distance. Take care while creating the loop because a larger loop tends to pick up more noise. If the wire shipped with the kit (4 inches in length) is wound to form a loop of 1 to 2 inch diameter, the proximity range will be approximately the same as the loop diameter for a fast approaching hand. To obtain a higher range, use a longer wire/bigger loop. Also, do not plug the wire loop after the device is programmed/powered, as the firmware tunes the proximity sensor during reset. Plugging the wire after a reset will be detected as change in capacitance, and the LED will be always on. Always do a reset after plugging in the wire loop if the device was already programmed.

Figure 5-17. CapSense Proximity Example - Hardware Setup

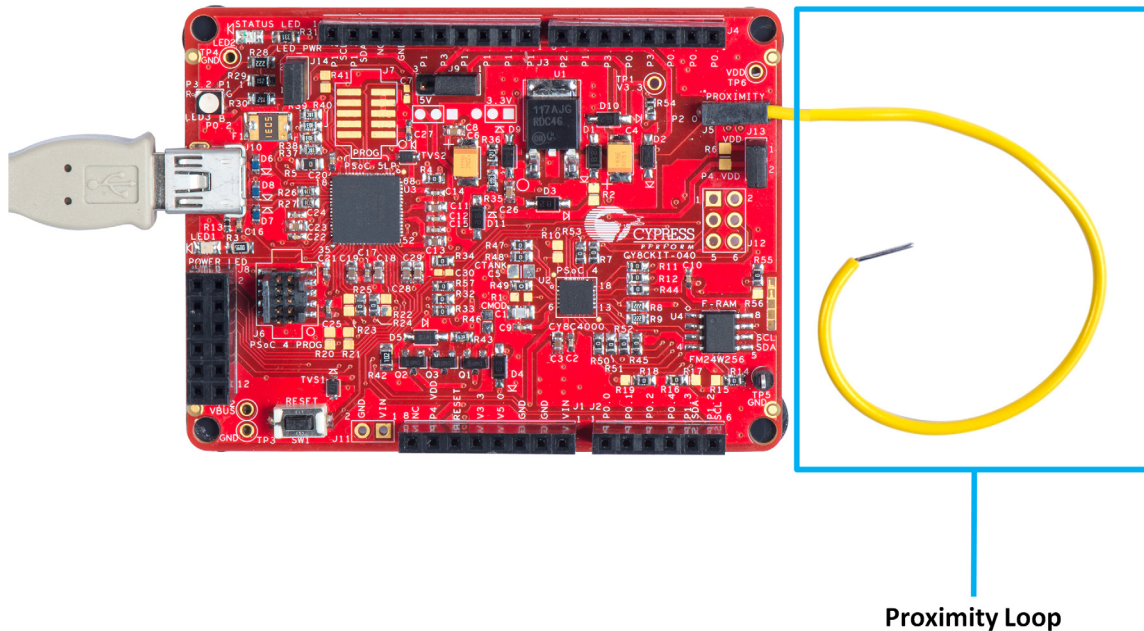

Open `CY8CKIT_040_Proximity_UART.cydwr` in the **Workspace Explorer** and select the suitable pins, as shown in [Figure 5-18](#).

Table 5-7. Pin Connections

Pin Name	Port Name
Proximity Pin	P2_0
CMOD Pin	P0_4
LED Pin	P3_2 (Red)
UART TX Pin	P3_0 ¹

1. Selected in firmware

Figure 5-18. Pin Selection for Proximity Project

Alias	Name	Port
Cmod	\CapSense:Cmod\	P0[4] CSD:c_mod, SRSS:ext_clk, TCPWM:tr_in[4], CSD:comp
ProximitySensor0_0_PROX	\CapSense:Sns\	P2[0]
	Pin_LED	P3[2] TCPWM:line_out

5.3.3 Verify Output

Build and program the code example, and reset the device. Observe the red LED intensity changing as you move your palm toward the proximity wire loop. The UART TX data can be viewed through the BCP, as explained in [5.3.3.1 UART Data Viewing](#).

Figure 5-19. CapSense Proximity Example Output

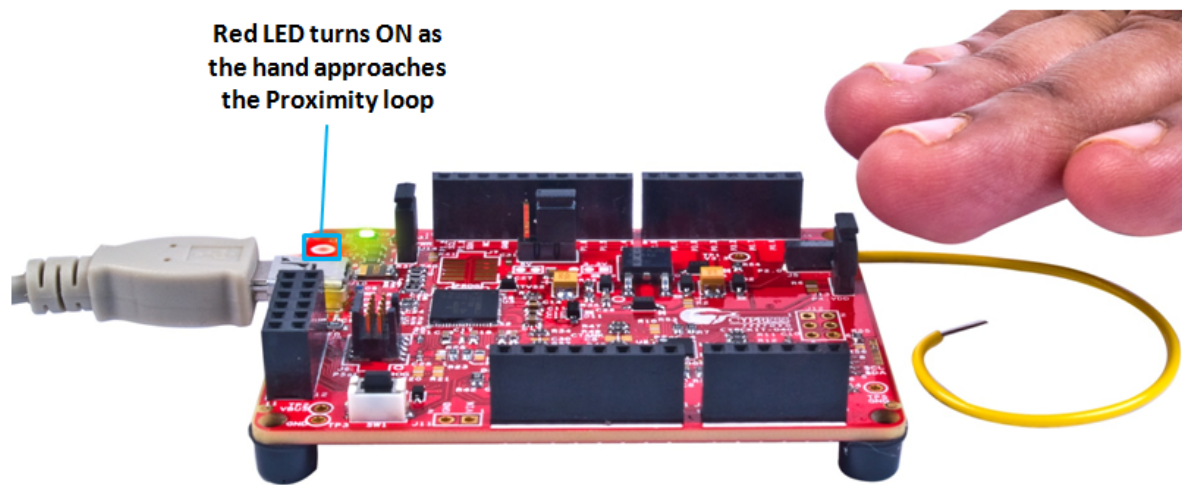

5.3.3.1 UART Data Viewing

One UART packet size is 13 bytes, which includes 8 bytes of data, 2 bytes of header, and 3 bytes of footer. The 2-byte header precedes the data bytes; in the design it is 0x0D and 0x0A. The 3-byte footer follows the data bytes and in this design consists of 0x00, 0xFF, and 0xFF. The data bytes consists of proximity sensor raw counts (RC), baseline (BL), and signal (SIG) along with the calculated PWM duty (DUTY). [Table 5-8](#) shows the UART TX data packet structure.

Table 5-8. UART TX Data Packet Structure

Header		Data				
BYTE 0	BYTE 1	BYTE 2	BYTE 3	BYTE 4	BYTE 5	BYTE 6
0x0D	0x0A	RC_MSB	RC_LSB	BL_MSB	BL_LSB	SIG_MSB
Data		Footer				
BYTE 7	BYTE 8	BYTE 9	BYTE 10	BYTE 11	BYTE 12	
SIG_LSB	DUTY_MSB	DUTY_LSB	0x00	0xFF	0xFF	

Follow these steps to set up the BCP for viewing the data:

1. Open the BCP software available from **All Programs > Cypress > Bridge Control Panel <version> > Bridge Control Panel <version>**.

2. Route the TX pin of the device to any available RX that can connect to the PC COM port. CY3240 (refer to [AN2397](#)), or KitProg in CY8CKIT-040 can be used for this purpose.

Note: In CY8CKIT-040, Pin 3_0 is routed directly to the RX pin of the PSoC 5 LP USB-UART bridge through a zero-ohm resistor. Pin 3_0 can be used as TX, and is available only by disabling the debug feature of the chip. If the debug feature is required along with TX, then the zero-ohm resistor connecting the TX and RX should be removed. Any free GPIO can be used as the TX for the device and can be routed to the RX pin of PSoC 5 LP externally (see the last step of [Programming the Example Projects on page 51](#) for details)

3. In the BCP software, click the COM port to which you have connected the data. In this case, it is KitProg's COM, as shown in [Figure 5-20](#).

Figure 5-20. KitProg COM Port in Device Manager

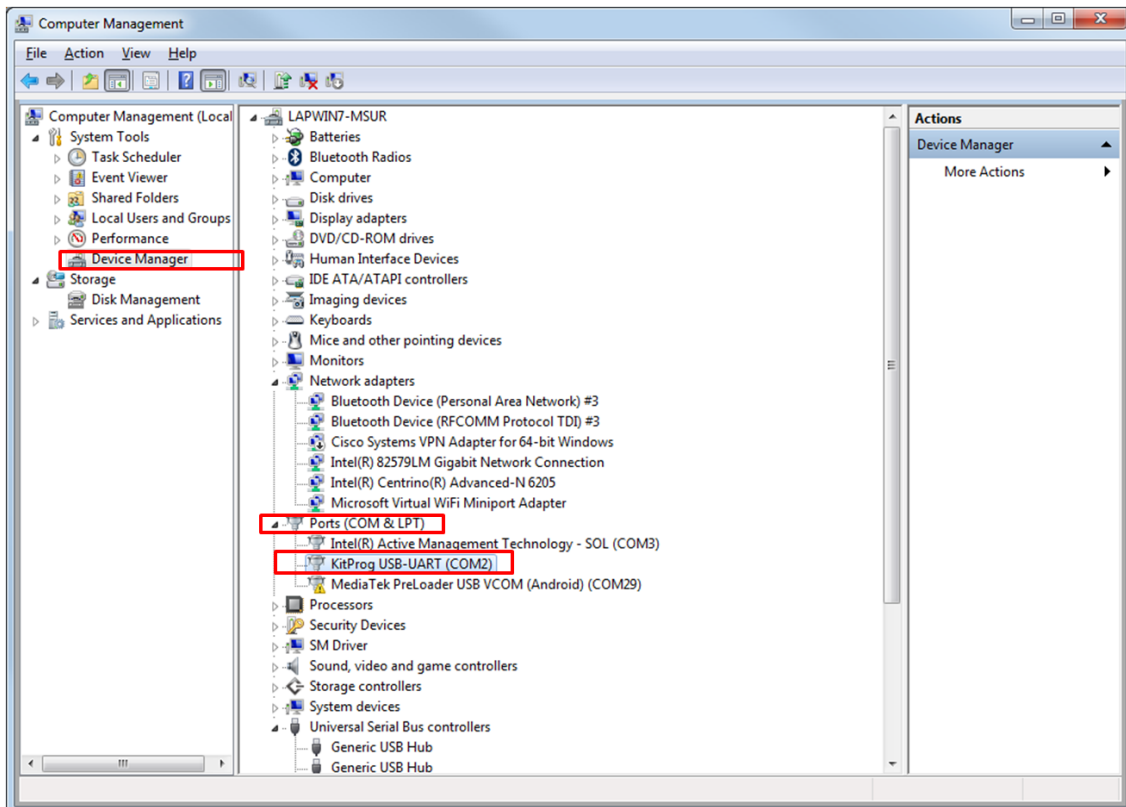

- Select the **COM** port and **RX8** as the protocol, as shown in [Figure 5-21](#).

Figure 5-21. Bridge Control Panel - COM Port and Protocol Selection

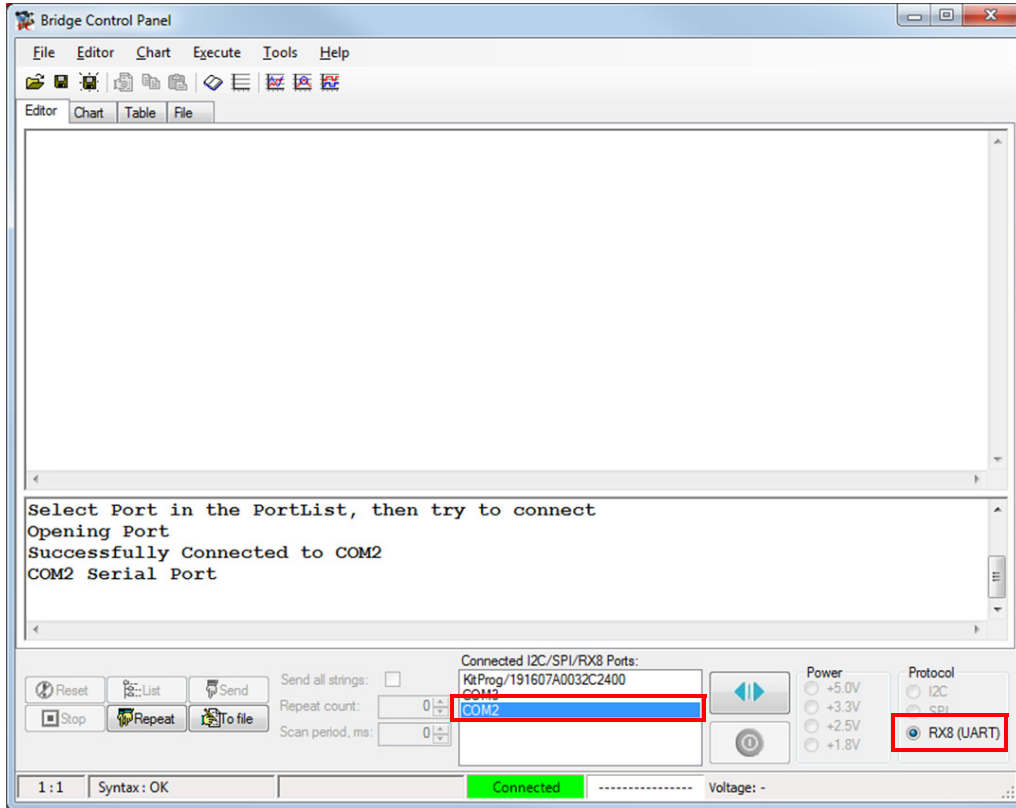

- Choose **Tools > Protocol Configuration** or press **[F7]** and configure the RX8 protocol parameters, as shown in [Figure 5-22](#).

Figure 5-22. RX8 Protocol Configuration

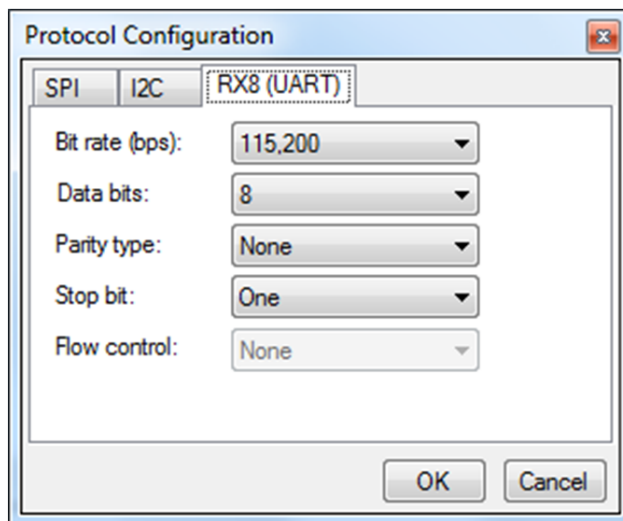

6. Choose **Chart > Variable Settings** and set the variable names and types, as shown in [Figure 5-23](#). Or click **Load** and then select the *CapSense Proximity UART - Variable.ini* file supplied with the project (`...\Firmware\PSOC 4\Bridge Files\`) in the **Open** window that appears. Click **OK** to exit.

Figure 5-23. Bridge Control Panel - Variable Settings

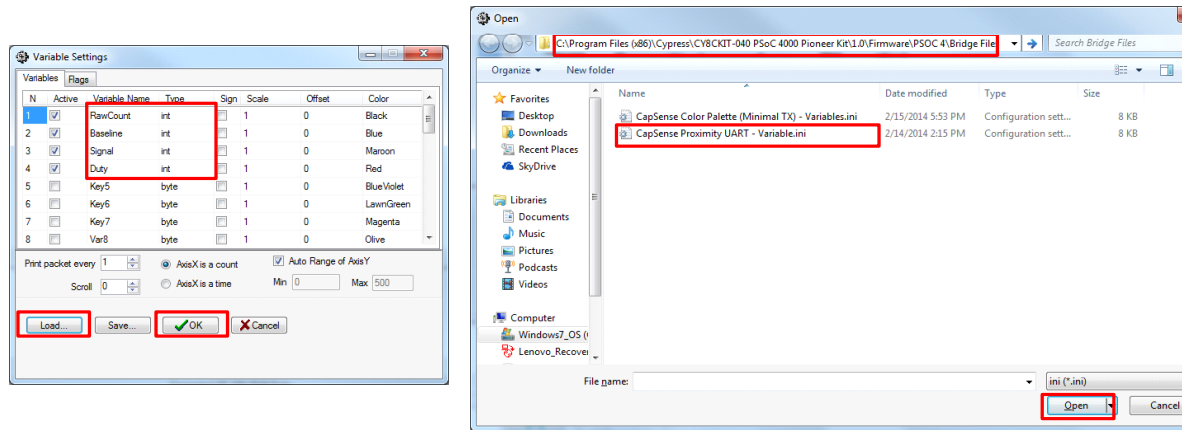

7. Choose **File > Open File** and select the *CapSense Proximity UART - Editor.iic* file supplied with the project from the `...\Firmware\PSOC 4\Bridge Files\` folder (as shown in [Figure 5-24](#)). Alternatively, go to **Editor** and type or copy the following command:
`rx8 [h=0D 0A] @1RawCount @0RawCount @1Baseline @0Baseline @1Signal @0Signal @1Duty @0Duty [t=00 ff ff]`

Figure 5-24. Open *.iic File in Bridge Control Panel

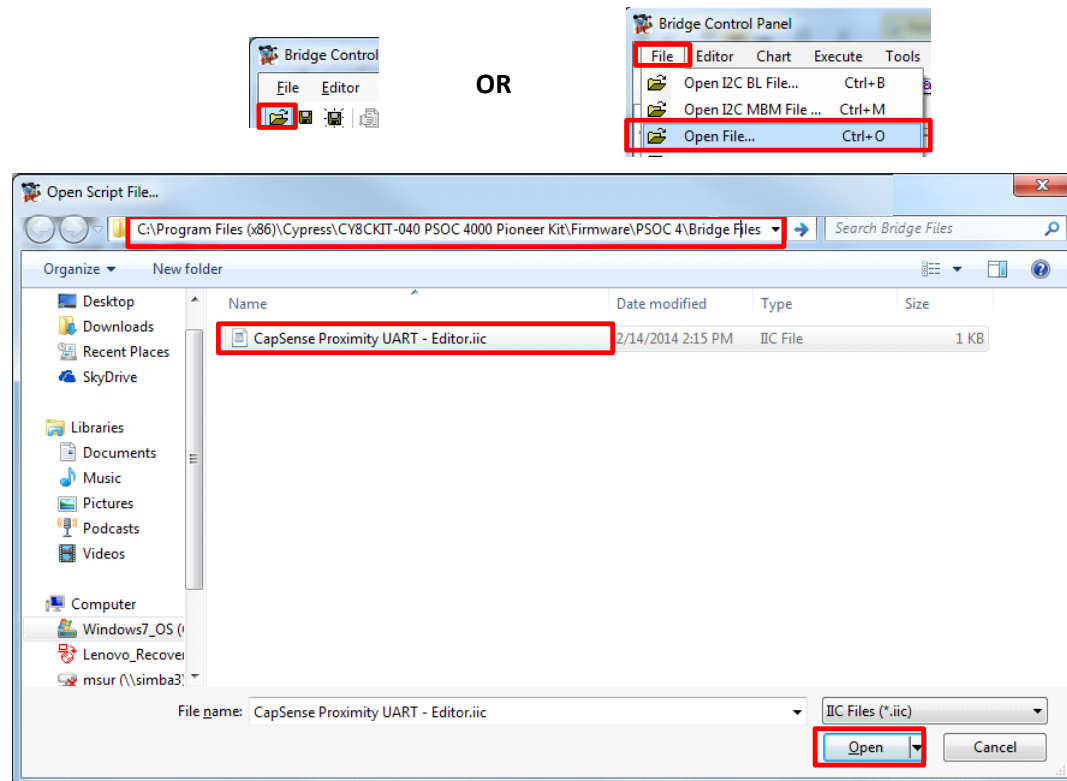

- Click the command line and then click **Repeat**, as shown in [Figure 5-25](#) to start receiving the packets (make sure you have powered the device and programmed with the project's firmware, the TX is connected to the RX line of the COM, and the COM port is selected in the BCP).

Figure 5-25. Bridge Control Panel - Protocol Execution

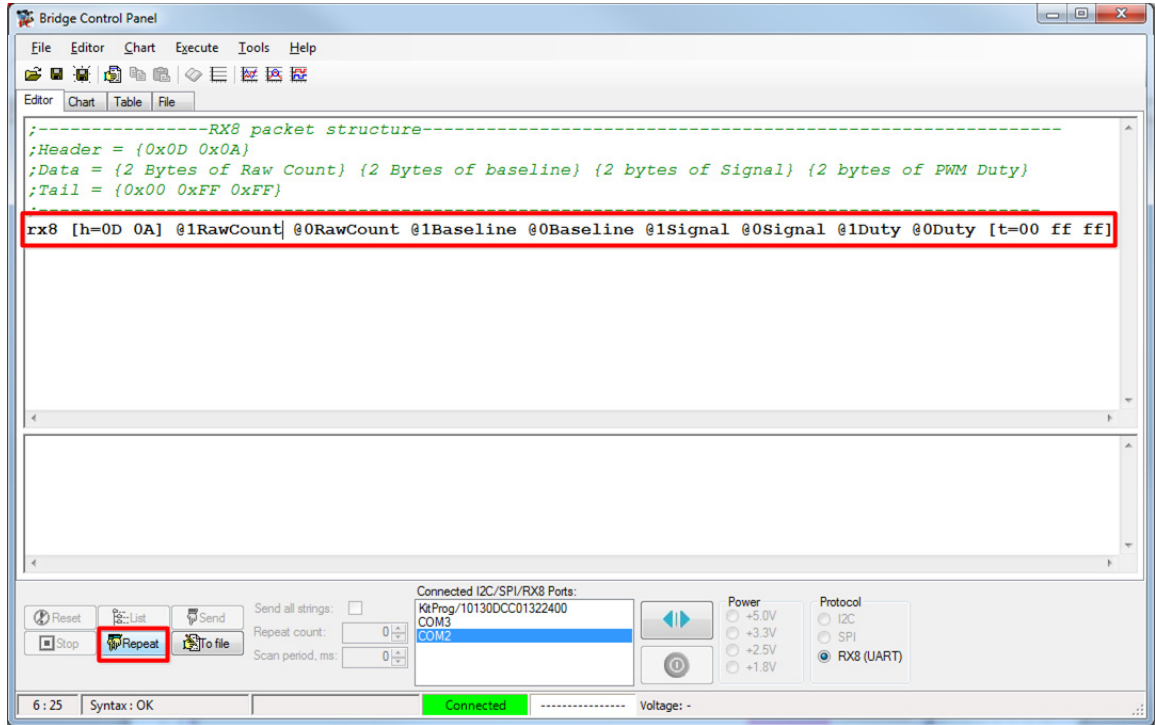

9. You should start receiving data. Click the **Chart** tab to view the graph, as shown in [Figure 5-26](#).

Figure 5-26. Bridge Control Panel - Chart for Viewing Debug Data
Signal

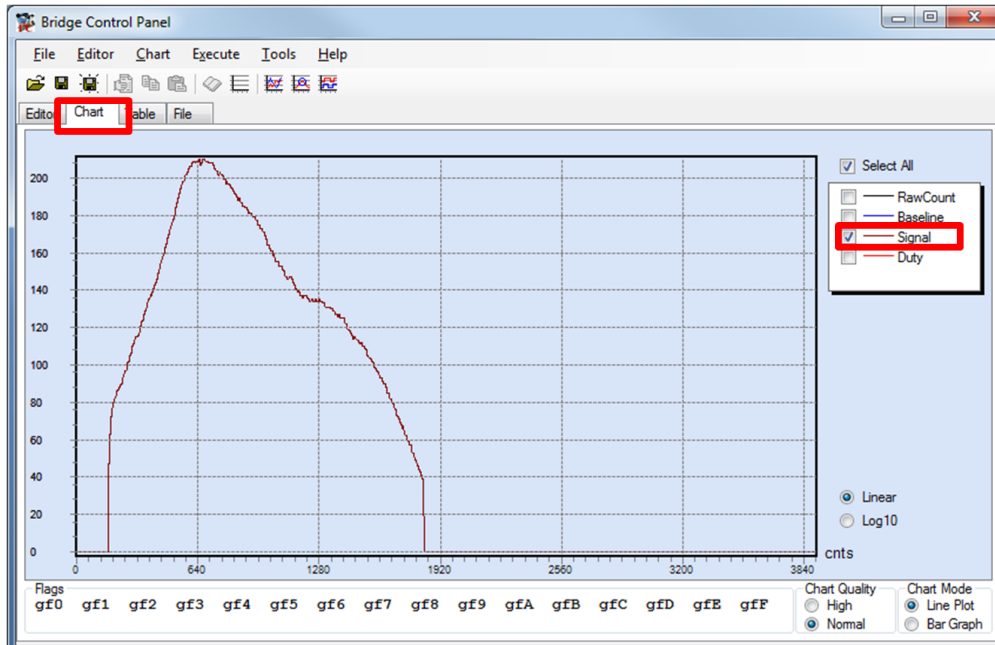

LED Intensity (PRSm duty cycle)

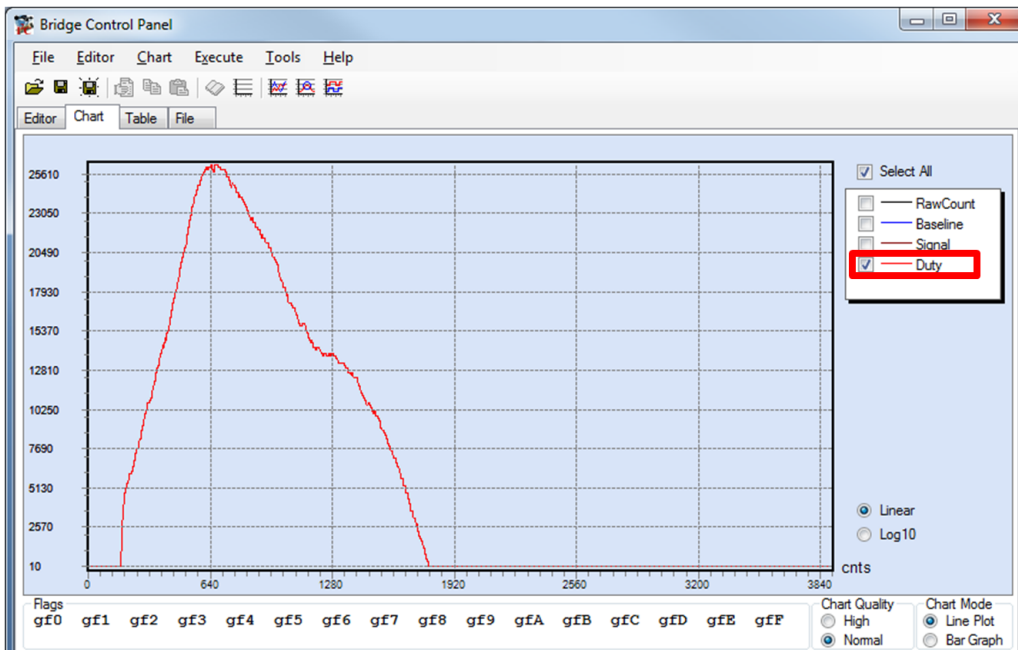

Raw count and Baseline

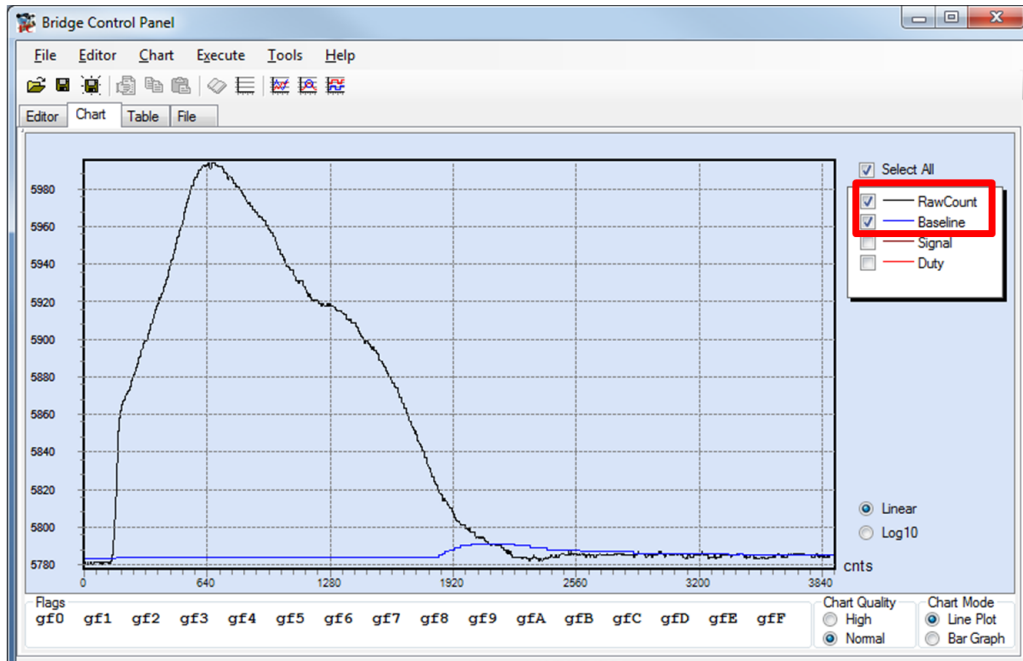

5.4 Project: CapSense Touchpad with I²C Tuner

5.4.1 Project Overview

The project *CY8CKIT_40_CapSense_I2C.cypri* demonstrates the implementation of a CapSense Touchpad using SmartSense and an EzI2C-based CapSense Tuner window for viewing the Trackpad coordinates. The project is a simple implementation using SmartSense (minimal tuning). The EzI2C block of PSoC 4000 is interfaced through the PSoC 5LP based USB-I²C bridge to the PC GUI. The project uses the SmartSense feature, which sets all CapSense parameters to the optimum values automatically. The parameter settings can be monitored in the GUI but cannot be altered. In the manual tuning method, parameter settings can be changed in the GUI, and the resulting output can be seen (refer to the [CapSense Design Guide](#) and CapSense Component datasheet for more details on manual tuning).

Note: This project requires the Trackpad shield board to be plugged into the PSoC 4000 Pioneer Kit baseboard, as shown in [Figure 5-27](#).

Figure 5-27. Kit Setup With Trackpad

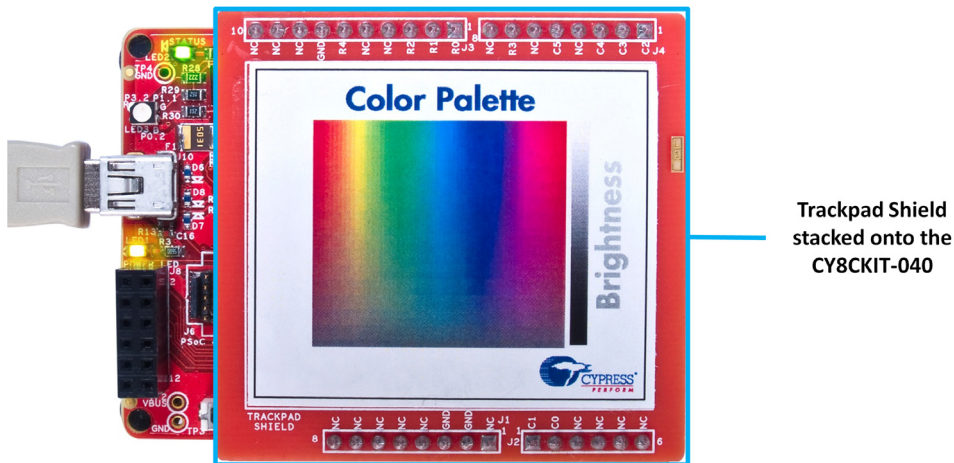
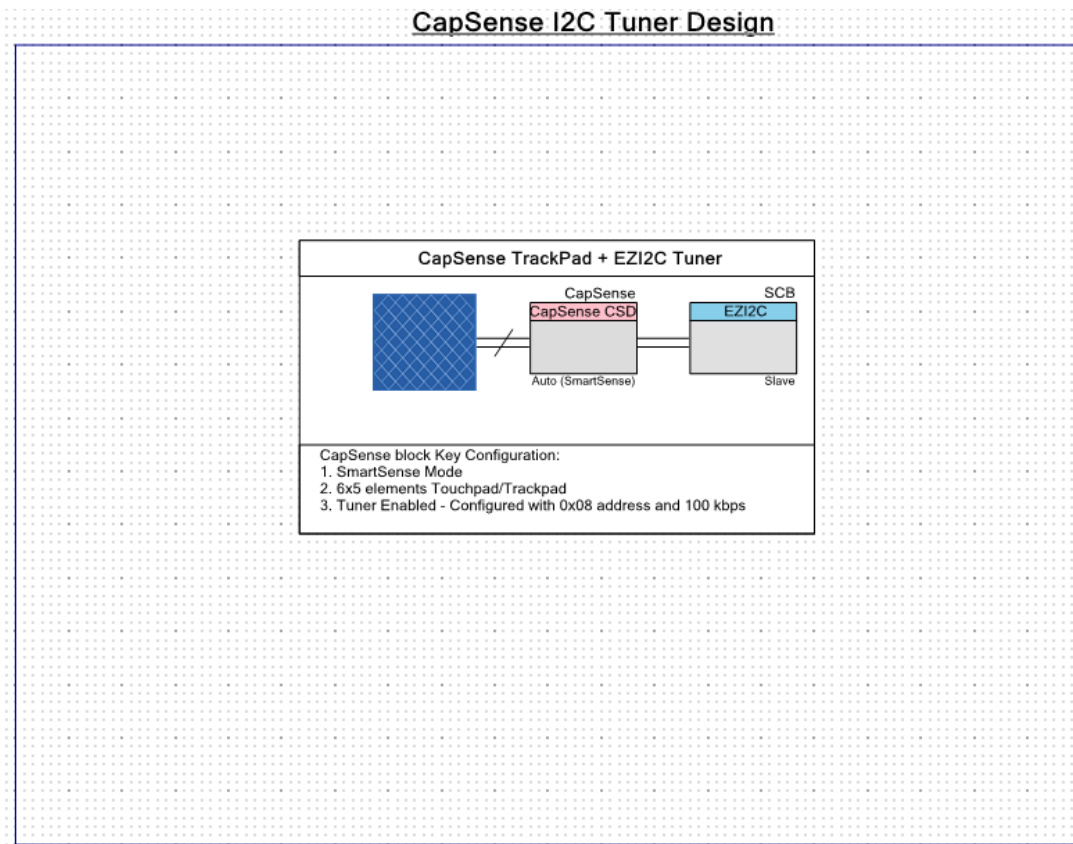

Figure 5-28. PSoC Creator Schematic Design of CapSense Trackpad Project with I²C Tuner



5.4.2 Project Description

5.4.2.1 PSoC Creator Component Configuration

CapSense

The CapSense Component is configured in SmartSense Auto-tuning mode with a 6x5 CapSense touchpad widget for the design, according to the parameters given in [Table 5-9](#).

Table 5-9. CapSense Component Parameters

Parameter	Tab Present	Value	Rationale
Tuning method	General	Auto(SmartSense)	Automatically adjust sensitivity for different system environments.
Threshold mode		Automatic	Enable run-time threshold calculation for 5:1 SNR
Raw data noise filter		First Order IIR 1/4	Filter out noise or unwanted spikes in raw count. This setting can be tweaked based on requirement.
TouchPad0	Widgets Config	-	Add and configure the touchpad as shown in Figure 5-29 .
Analog switch drive source	Advanced	PRS-Auto	Reduce EMI emission and enhance EMC immunity.
Sensor auto-reset		Disabled	Not required in the design. Add if required by the application.
Low baseline reset		5	System-dependent number. Configure according to user needs.
Inactive sensor connection		Ground	Make the proximity loop not pick up any charge when not scanned.
Shield		Disabled	Not used in the design.
Guard sensor		Disabled	Not used in the design.
Cmod precharge		Precharge by Vref buffer	Vref is enough for precharging, as there is only one sensor. Cmod voltage will not drop too low for a fast GPIO precharge.
Sensitivity	Scan Order	5	Select all the sensors by pressing and holding [CTRL] or [Shift] key and clicking on all the sensors. When selected, enter a value in the Sensitivity field.
Enable Tuner helper	Tune helper	Enabled/Checked	Name = 'SCB'

Figure 5-29. CapSense Touchpad Parameters

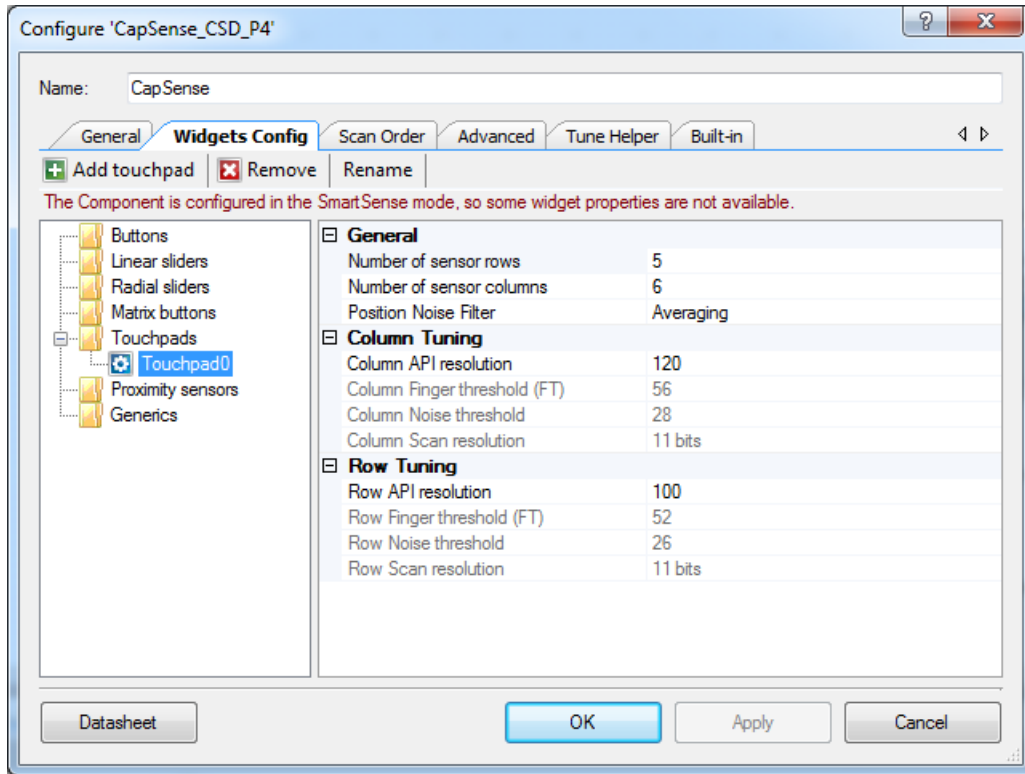

SCB (EzI2C Mode)

The Serial Communication Block (SCB) configured in EzI2C mode is used for the CapSense Tuner. The parameters of the component are shown in Figure 5-30.

Figure 5-30. SCB (EZI2C Mode) Component Parameters

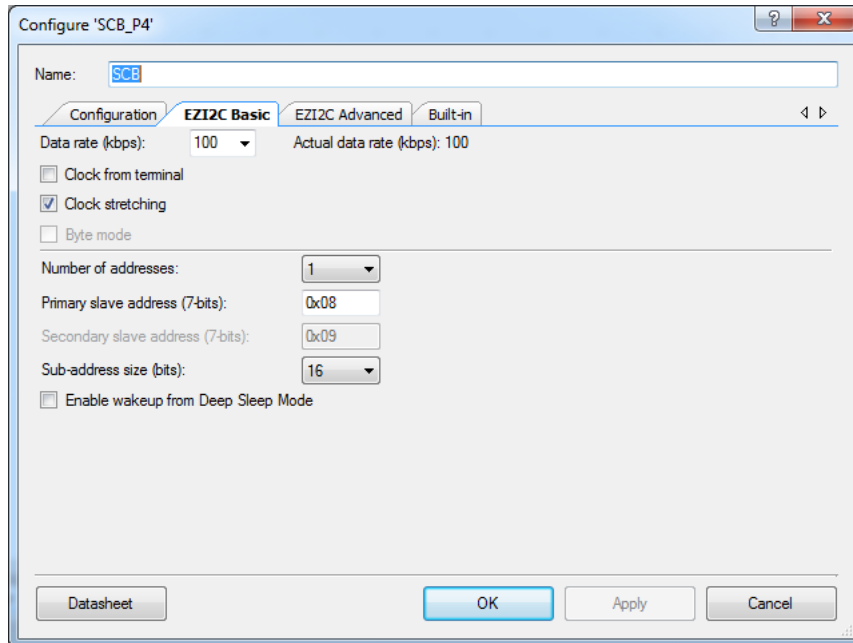

5.4.2.2 Firmware Details

Figure 5-31 shows the flow chart of code implemented in *main.c*.

Figure 5-31. CapSense Touchpad With I²C Tuner Project Flow Chart

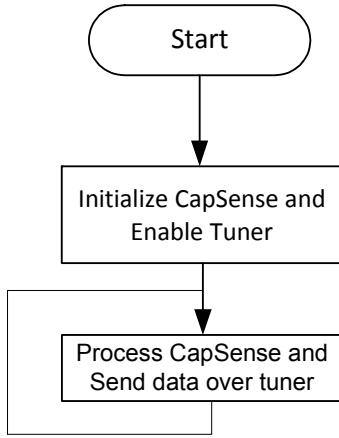

5.4.2.3 Hardware Connections

Plug the Trackpad shield board into the Arduino headers of the kit, as shown in [Figure 5-27](#). Other connections are hardwired on the board.

Open *CY8CKIT_040_CapSense_I2C.cydwr* in the **Workspace Explorer** and select the suitable pin.

Table 5-10. Pin Connection¹

Pin Name	Port Name
CMOD	P0_4
Trackpad_X0	P0_3
Trackpad_X1	P0_7
Trackpad_X2	P0_6
Trackpad_X3	P0_5
Trackpad_X4	P0_0
Trackpad_X5	P0_1
Trackpad_Y0	P1_4
Trackpad_Y1	P1_5
Trackpad_Y2	P1_6
Trackpad_Y3	P1_0
Trackpad_Y4	P1_7
I2C_SCL	P1_2
I2C_SDA	P1_3

1. Trackpad_X0 (Touchpad0_Col0_TP) to Trackpad_X5 (Touchpad0_Col5_TP) maps to COL5 to COL0 of the Trackpad so as to make the Trackpad x-axis left aligned.

Figure 5-32. Pin Selection for CapSense I²C Project

Alias	Name	Port	Pin	Lock
Cmod	\CapSense:Cmod\	P0[4] CSD:c_mod, SRSS:ext_clk, TCPWM:tr_in[4], CSD:comp	5	<input checked="" type="checkbox"/>
Touchpad0_Col0_TP	\CapSense:Sns[0]\	P0[3] TCPWM:tr_in[3]	4	<input checked="" type="checkbox"/>
Touchpad0_Col1_TP	\CapSense:Sns[1]\	P0[7]	11	<input checked="" type="checkbox"/>
Touchpad0_Col2_TP	\CapSense:Sns[2]\	P0[6]	10	<input checked="" type="checkbox"/>
Touchpad0_Col3_TP	\CapSense:Sns[3]\	P0[5]	9	<input checked="" type="checkbox"/>
Touchpad0_Col4_TP	\CapSense:Sns[4]\	P0[0] TCPWM:tr_in[0]	1	<input checked="" type="checkbox"/>
Touchpad0_Col5_TP	\CapSense:Sns[5]\	P0[1] TCPWM:tr_in[1], CSD:comp	2	<input checked="" type="checkbox"/>
Touchpad0_Row0_TP	\CapSense:Sns[6]\	P1[4] TCPWM:tr_underflow	16	<input checked="" type="checkbox"/>
Touchpad0_Row1_TP	\CapSense:Sns[7]\	P1[5] TCPWM:tr_overflow	17	<input checked="" type="checkbox"/>
Touchpad0_Row2_TP	\CapSense:Sns[8]\	P1[6] TCPWM:tr_overflow, TCPWM:line_out_compl, TCPWM:tr_underflow, CSD:comp	18	<input checked="" type="checkbox"/>
Touchpad0_Row3_TP	\CapSense:Sns[9]\	P1[0]	12	<input checked="" type="checkbox"/>
Touchpad0_Row4_TP	\CapSense:Sns[10]\	P1[7] SRSS:ext_clk, TCPWM:tr_compare_match	19	<input checked="" type="checkbox"/>
	\SCB:scl\	P1[2] SCB:i2c_scl	14	<input checked="" type="checkbox"/>
	\SCB:sda\	P1[3] SCB:i2c_sda	15	<input checked="" type="checkbox"/>

5.4.3 Verify Output

Build and program the code example and reset the device. Launch the CapSense Tuner window as explained in the following steps.

5.4.3.1 Launching Tuner Window

The Tuner window from PSoC Creator must be up and running for the code example to work. To launch the GUI, follow these steps:

1. Go to the project's *TopDesign.cysch* file, as shown in [Figure 5-33](#).

Figure 5-33. Top Design File

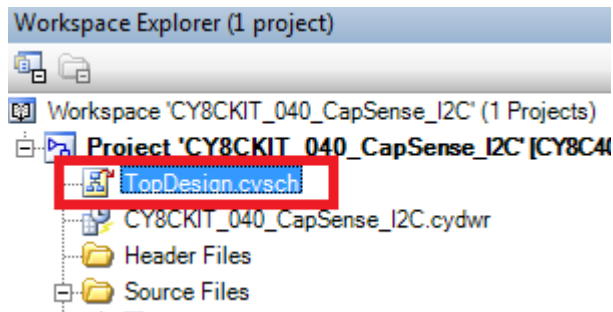

- To launch the Tuner, right-click the CapSense Component in PSoC Creator and click **Launch Tuner**, as shown in [Figure 5-34](#).

Figure 5-34. Launch Tuner

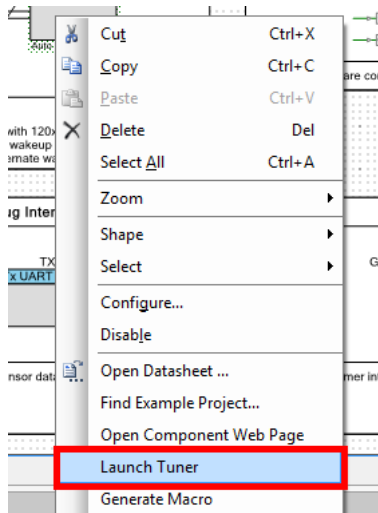

- The Tuner window opens. Click **Configuration** to open the configuration window, as shown in [Figure 5-35](#).

Figure 5-35. Tuner Window

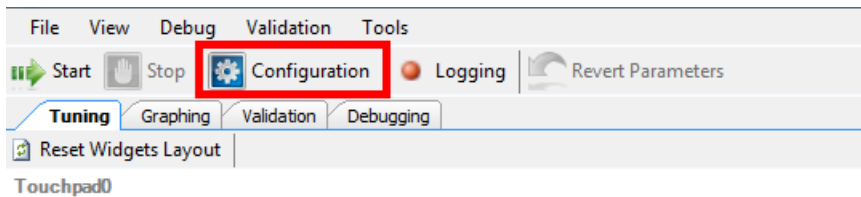

- Set the I²C communication parameters, as shown in [Figure 5-36](#).

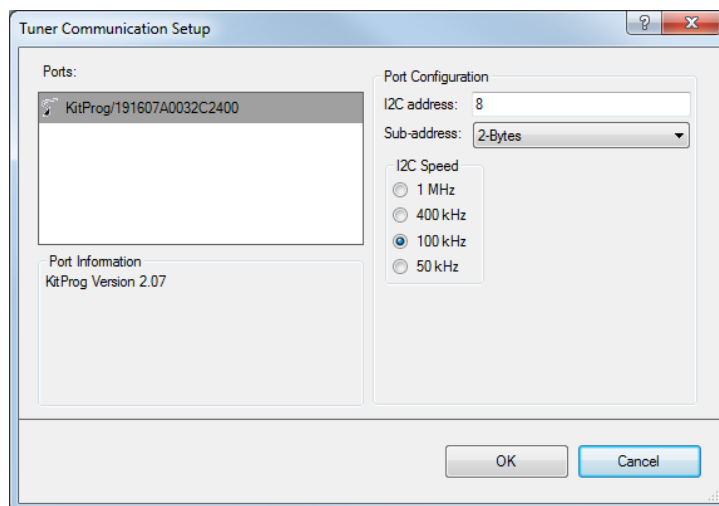
Figure 5-36. I²C Communication

- Click **OK** to apply the settings.

5.4.3.2 Verify Output

- To start the scanning and communication process, click **Start** in the Tuner window, as shown in Figure 5-37.

Figure 5-37. Start Communication

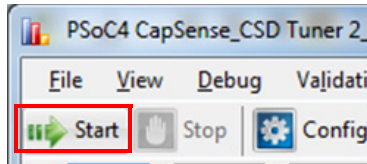

- Select a sensor in the **Tuning** tab. A red outline is displayed on the selected sensor. Different CapSense parameters are shown on the bottom right. You cannot edit the settings because auto-tuning is used in this project; auto-tuning automatically sets all the parameters. Touch the selected sensor and observe the response in the Tuner window.

Figure 5-38. Widget Testing

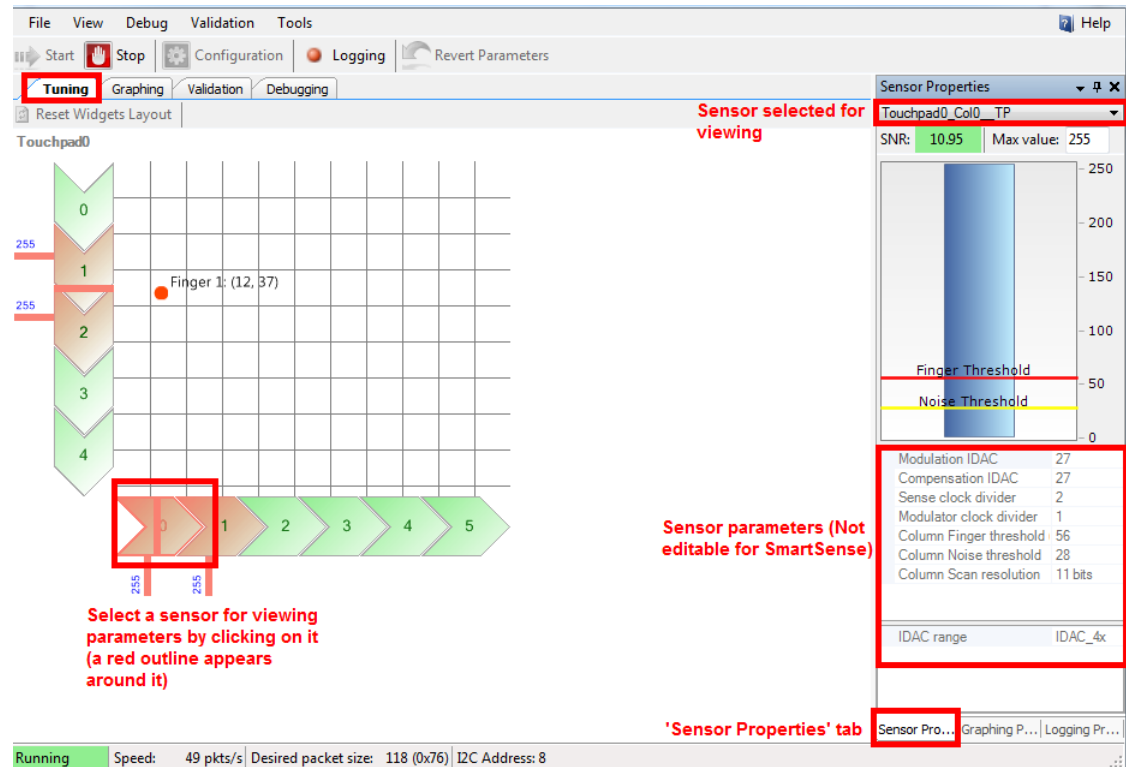

- In the **Graphing** tab, the CapSense data – Raw counts, Baseline, and Signal (difference count) for each sensor are represented as a graph.

- Select the sensor parameters to observe, as shown in [Figure 5-39](#). The graph of the selected parameters appears.

Figure 5-39. Sensor Parameter Graph

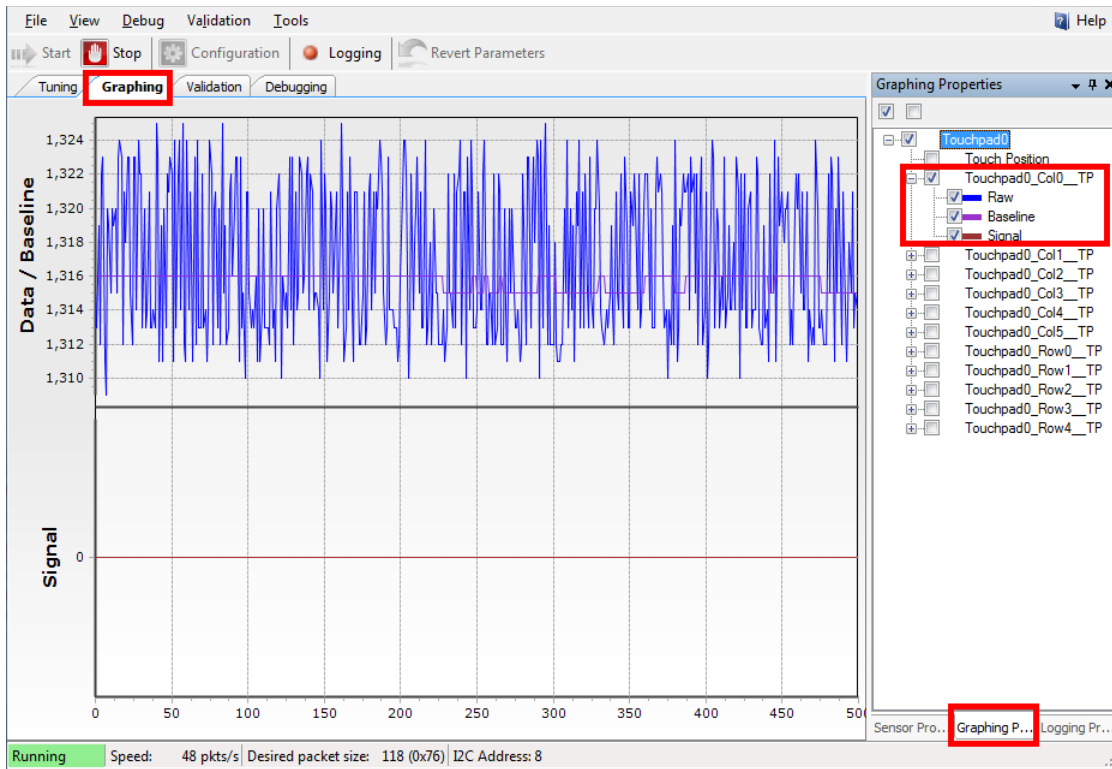

5. Touch a sensor or slider element and see the increase in Raw count and Signal, as shown in Figure 5-40.

Figure 5-40. Raw Count Increase

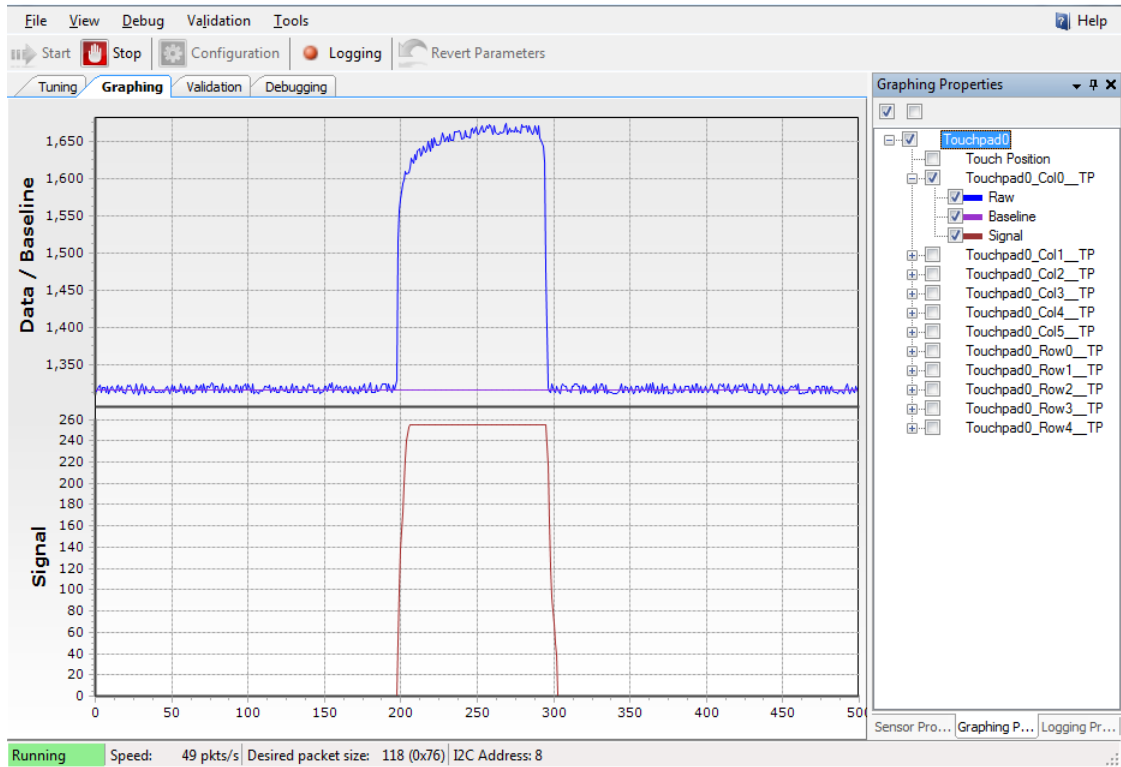

5.5 Project: Color Palette

5.5.1 Project Overview

The project *CY8CKIT_040_Color_Palette.cypri* demonstrates the capability of PSoC 4000 device to interface with a capacitive Trackpad and control an RGB LED based on the color selected by touching the sticker on top of the Trackpad. The sticker will also include a slider area (part of Trackpad), which will control the color brightness of the RGB LED. The project will demonstrate the proximity sensing capability of the device using a wire. The LED intensity control is done using software Precision Illumination Signal Modulator (PrISM). The project details are discussed in [Firmware Details on page 91](#). [Figure 5-41](#) shows the top design schematic of the project.

Figure 5-41. PSoC Creator Schematic Design of Color Palette Project

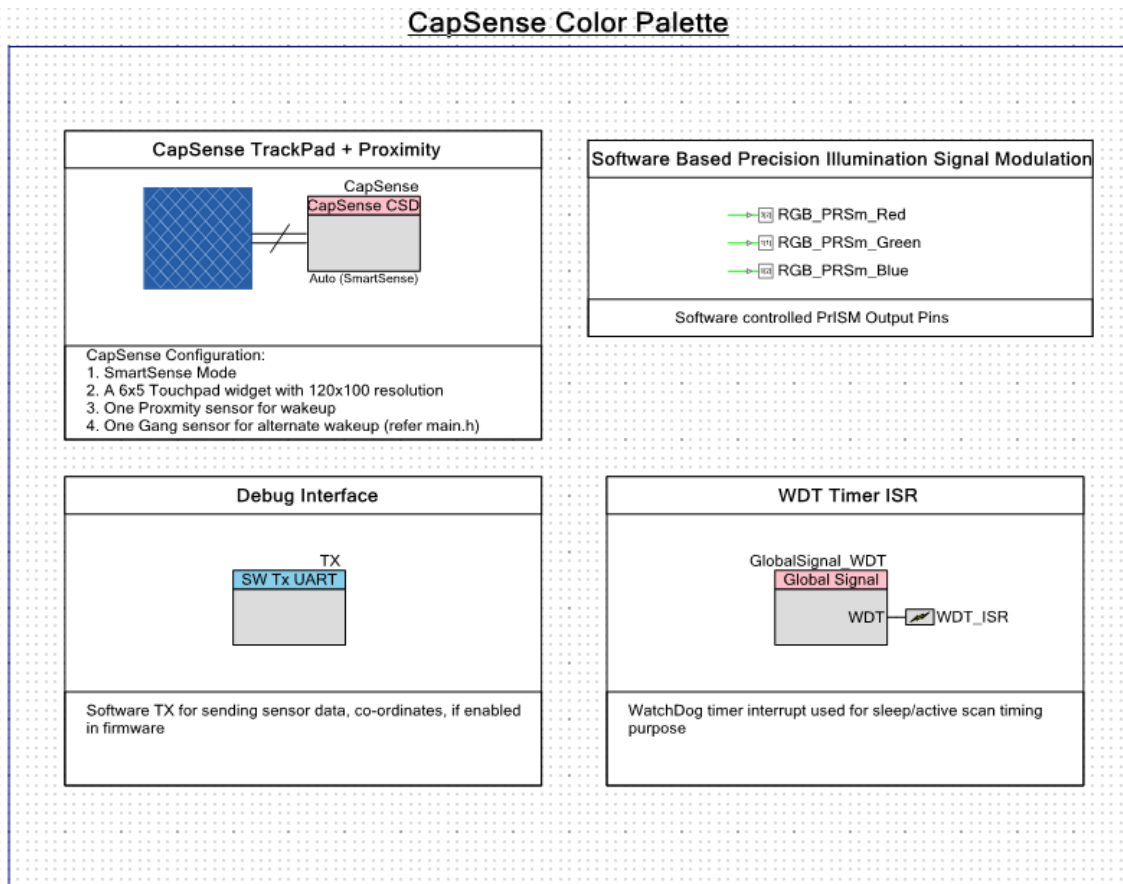

5.5.2 Project Description

5.5.2.1 PSoC Creator Component Configuration

CapSense:

The CapSense Component is configured in SmartSense Auto-tuning mode with one 6x5 touchpad, one dedicated proximity sensor, and a dummy/gang proximity sensor for the design with the parameters shown in [Table 5-11](#).

Refer to the [PSoC 4 CapSense Design Guide](#) or the [CapSense component datasheet](#) for details on various widgets used and parameters.

Table 5-11. CapSense Component Parameters

Parameter	Tab Present	Value	Rationale
Tuning method	General	Auto(SmartSense)	Automatically adjust sensitivity for different system environments.
Threshold mode		Automatic	Enable run-time threshold calculation for 5:1 SNR.
Raw data noise filter		First Order IIR 1/8	Filter out noise/unwanted spikes in raw count. This setting can be tweaked based on requirement.
TouchPad0	Widgets Config	–	Add and configure the touchpad as shown in Figure 5-42 .
ProximitySensor 0		–	Add and configure a proximity sensor as shown in Figure 5-42 .
ProximitySensor 1		–	Add and configure a proximity sensor (Gang) as shown in Figure 5-42 . Note that this sensor is a dummy sensor, which is ganged with the row elements of the touchpad for wakeup.
Analog switch drive source	Advanced	PRS-Auto	For reduced EMI emission and enhanced EMC immunity.
Sensor auto reset		Disabled	Not required in the design. Can be added if required by the application.
Low baseline reset		5	System dependent number. Can be configured as per the user needs.
Inactive sensor connection		Ground	Make sure the proximity loop does not pick up any charge when not scanned.
Shield		Disabled	Not used in the design.
Guard sensor		Disabled	Not used in the design.
Cmod pre-charge		Precharge by Vref buffer	Vref is enough for precharging here, as there is only one sensor, Cmod voltage will not drop too low for a fast GPIO precharge.
Sensitivity	Scan Order	4	Select all the sensors by pressing and holding [CTRL] or [Shift] and clicking on all the touchpad sensors. When selected, enter the value in the Sensitivity field.
		1	Click ProximitySensor0 and set sensitivity as '1' for maximum range.
		5	Click ProximitySensor1 and set sensitivity as '5' for minimum resolution of scan during sleep scan for reduced power consumption.
Sensor ganging		-	Gang the touchpad row elements to ProximitySensor1 as shown in Figure 5-43 .
Enable Tuner helper	Tuner Helper	Disabled/unchecked	No tuner used.

Figure 5-42. CapSense Touchpad Parameters

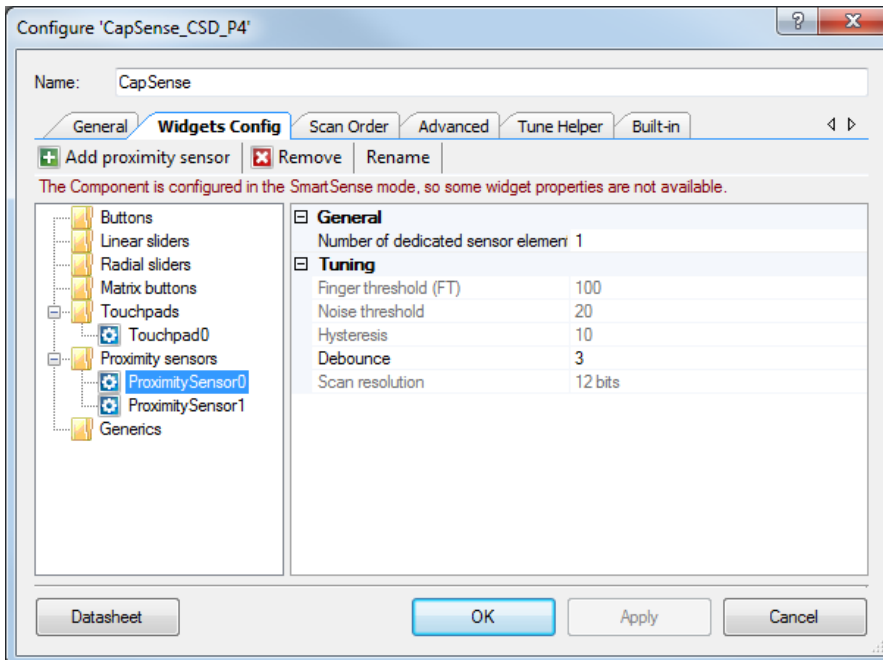
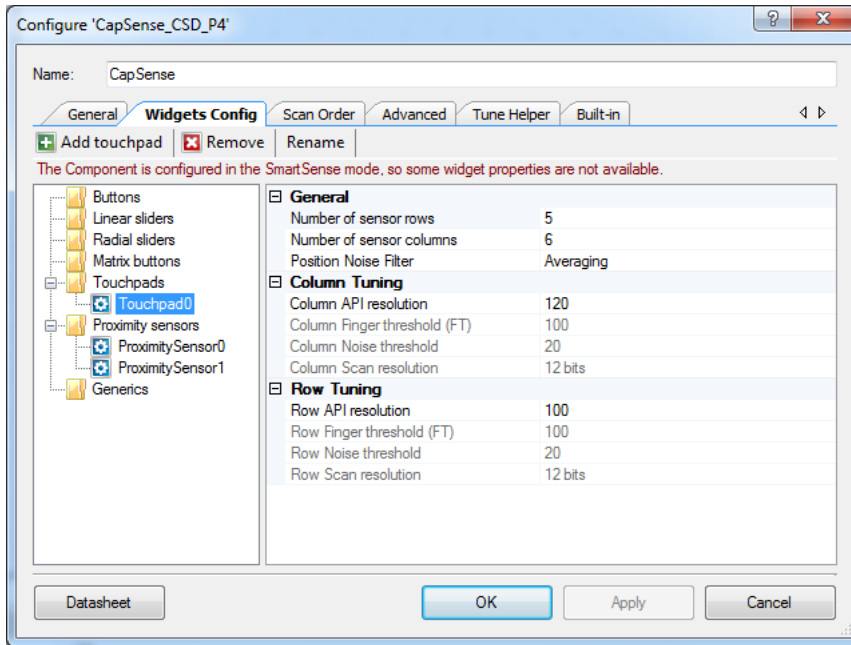

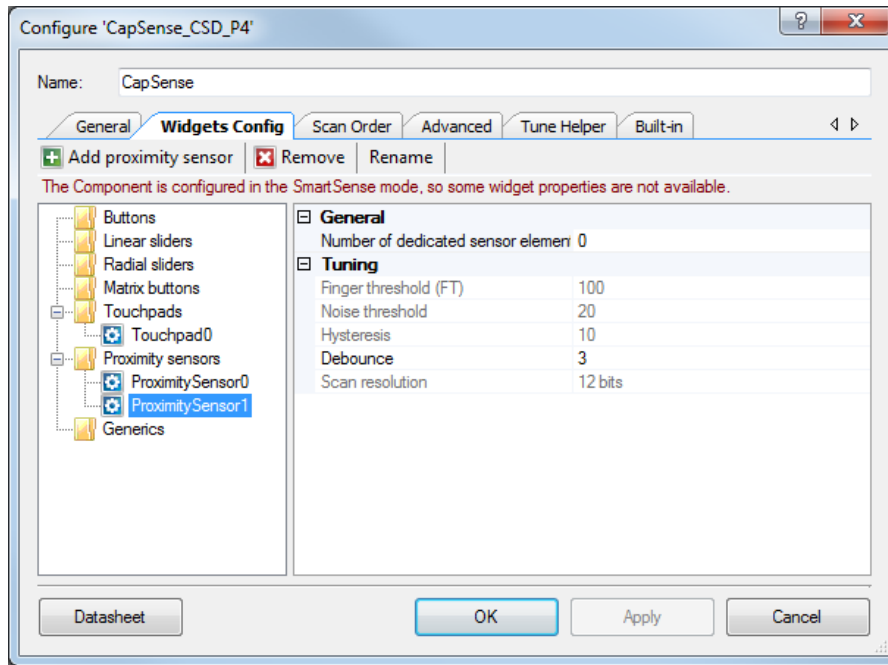
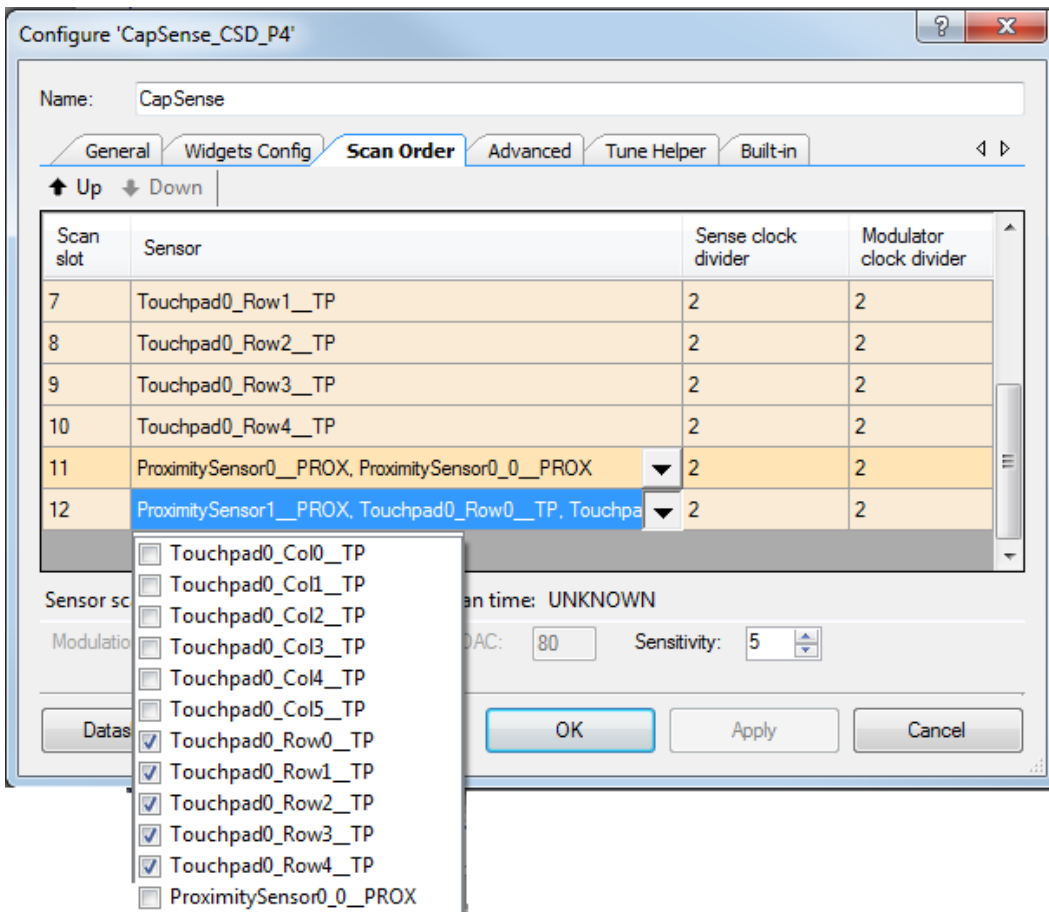

Figure 5-43. Scan Order Tab in CapSense Component Configure Window



TX (SW TX UART)

The software transmit TX is used to send out sensor data for debugging if enabled in firmware (refer to *main.h* in the project). The configuration for the component is shown in [Figure 5-44](#). The SW TX can be sent over to PC using either an RS-232 connector (with a voltage level translator in between) or through USB-UART bridge available in CY8CKIT-040 PSoC 5 LP UART Bridge or CY3240 bridge configured as UART bridge, as documented in [AN2397](#). The TX pin, if enabled, is configured in firmware through TX_PORT and TX_PIN macro available in *main.h*.

Note: By default, P3[0] is used for TX in firmware and P3[0] is hardwired in CY8CKIT-040 to the PSoC 5LP USB-UART bridge's RX line. So SWD debug cannot be used if P3[0] is used for TX and is enabled in firmware. Refer to the last step in [Programming the Example Projects on page 51](#) for details on how to use SWD debug and TX in the same project.

Figure 5-44. Software UART TX Component Parameters

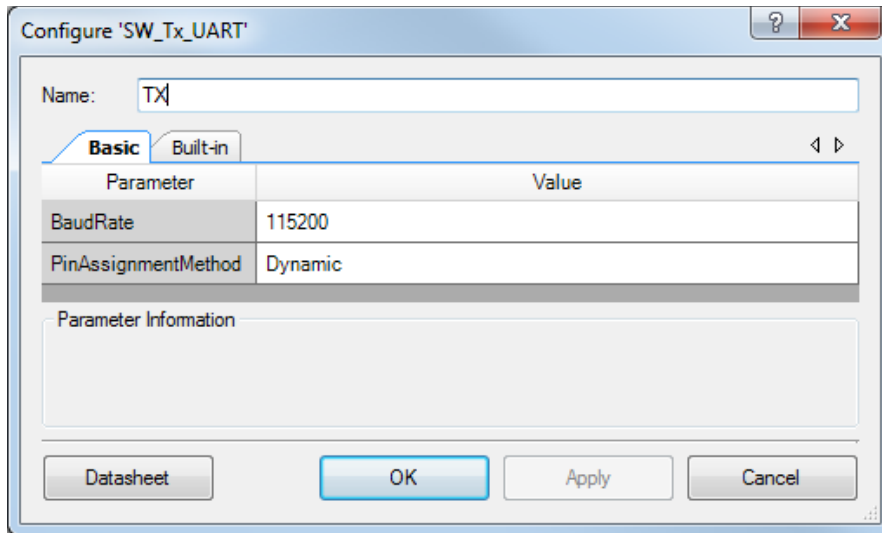

RGB_PRSm_<Color> (Digital Output Pin)

To drive the software PRISM output to the respective <color> LEDs. It is a standard strong drive firmware controlled output pin.

GlobalSignal_WDT (Global Signal Reference with ISR)

This component is used to route the WDT ISR to an ISR Component. This ISR is then configured in firmware for generating periodic wakeup signal using WDT during Sleep_Scan mode.

5.5.2.2 *Firmware Details*

Firmware Structure

The color palette firmware is written in a modular format with different aspects of the functionality provided in separate functions, source, and header files. This enables users to understand the firmware structure better and to modify the firmware easily to meet the application requirements. The key aspects of the firmware can be modified to meet a different application requirement using various macros defined in the *main.h* file.

Table 5-12. Source Files and Header Files in the Color Palette Project

File Names	Purpose
RGB_PRSm.c, RGB_PRSm.h	These files contain the implementation of the software PRS modulator, which controls the LED intensity.
main.c	This file contains all the function definitions used in the firmware.
main.h	This file contains all the macro definitions, imported variables, and exported function declarations. Key aspects of the firmware can be modified by changing the macro values in this file.

Firmware Flow Chart

Figure 5-45 shows the flow chart of code implemented in main.c.

Figure 5-45. Color Palette Project Flow Chart

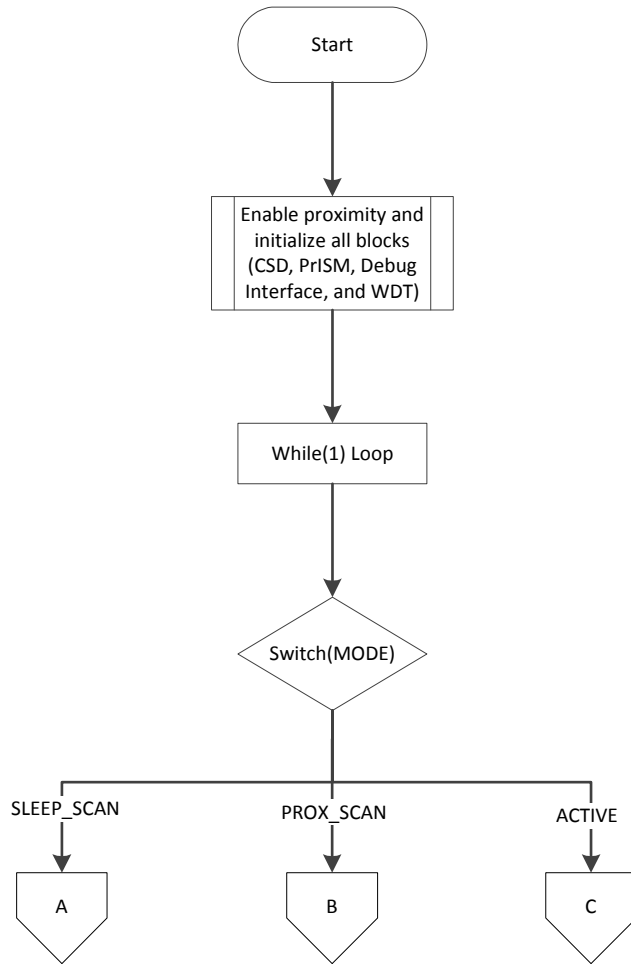

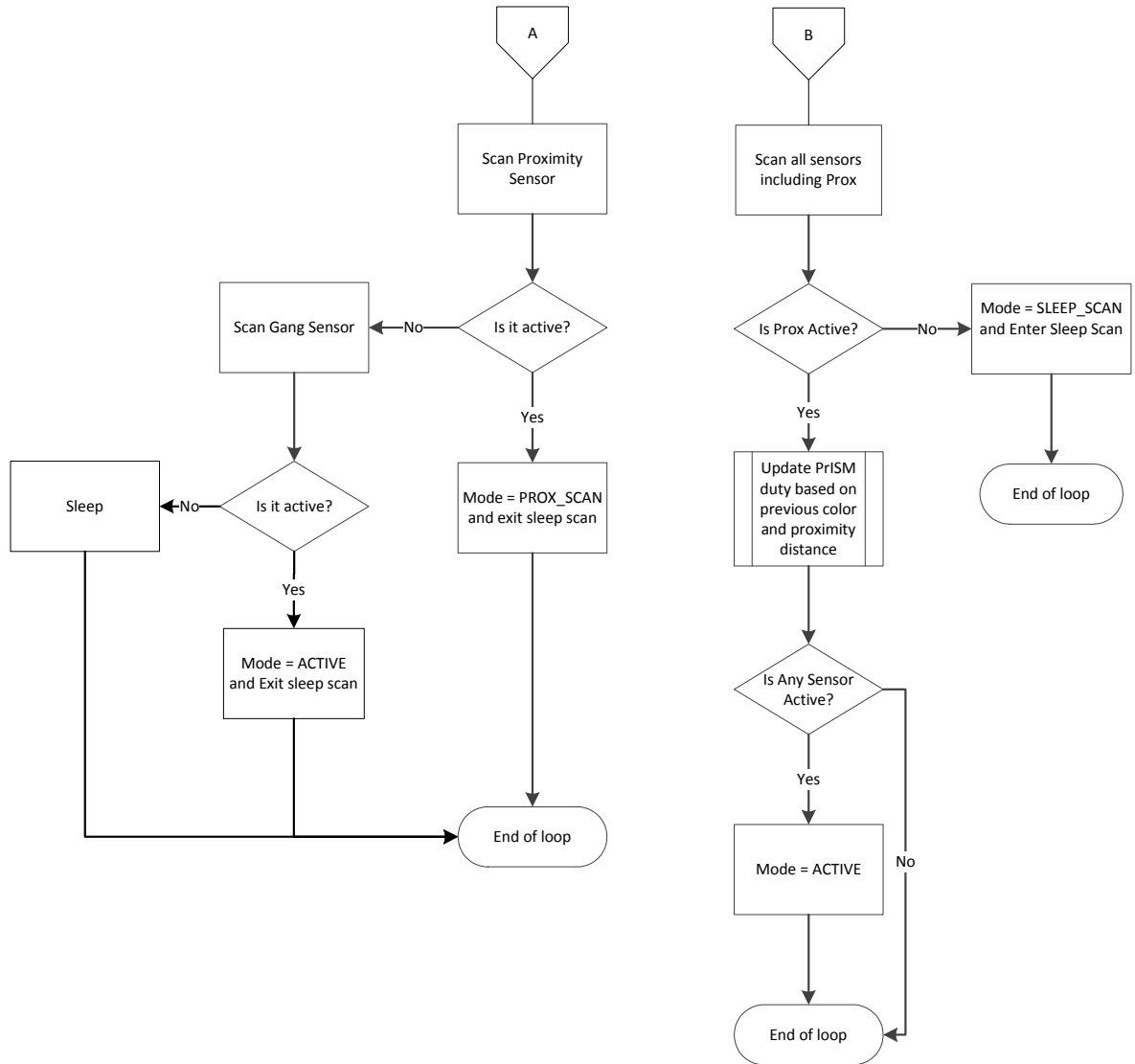

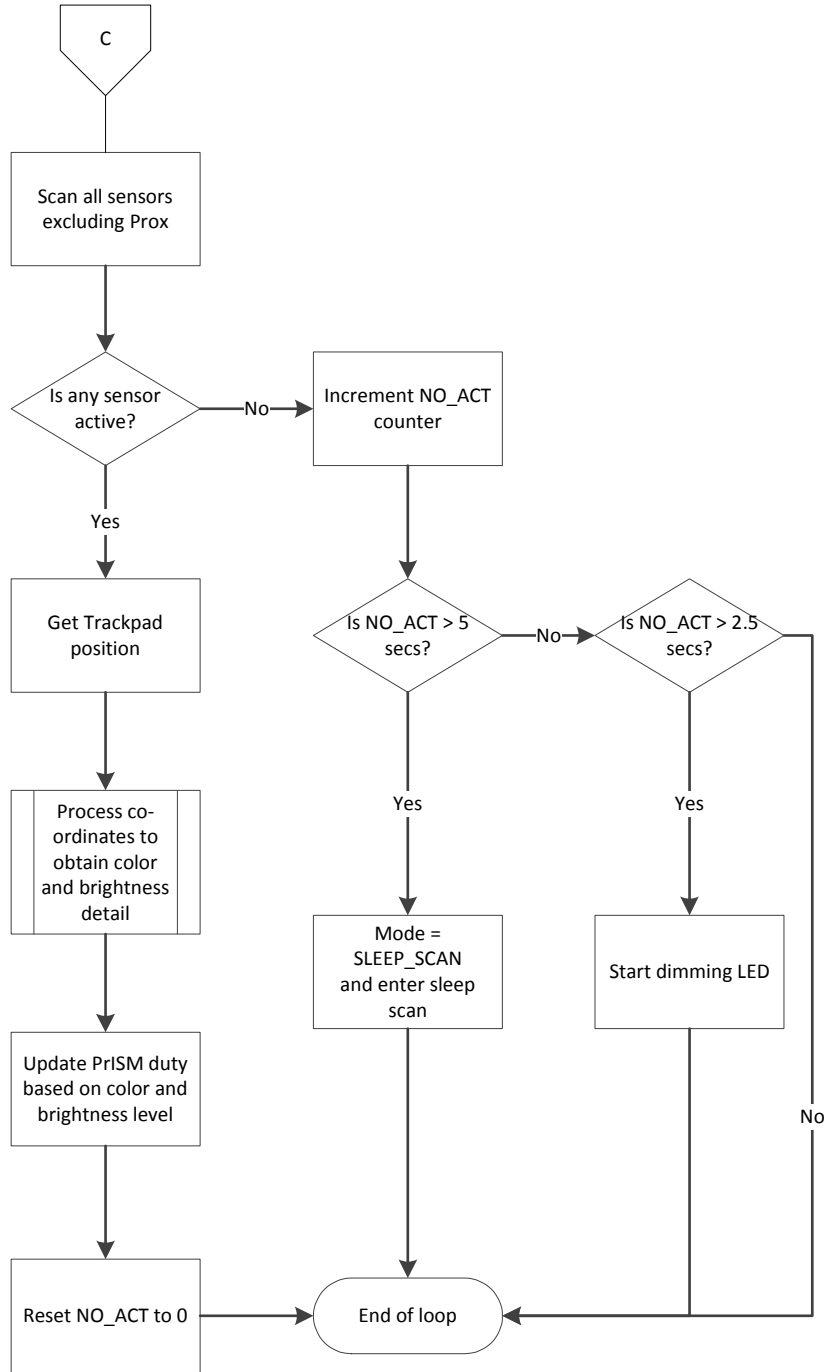

Firmware Implementation Details

The firmware consists of three different modes: active scanning (ACTIVE_SCAN), sleep scanning (SLEEP_SCAN), and proximity scanning (PROX_SCAN)

- Active Scanning: Active scanning primarily performs two tasks:
 - Scans the touchpad
 - Updates the color based on touchpad activity

Scanning the touchpad sensors along with the proximity sensor, if enabled, in turn performs two sub-tasks:

- Keeps the device in active scan mode
- Calculates the touch coordinate itself

Any activity on the touchpad or proximity sensor keeps the device in active scanning mode. If all activity ceases, the firmware will fade off the RGB color displayed and enter sleep scanning mode. The timeline at which the LED fades from last detected touch/proximity activity is defined by the macro LED_DIM_THRESHOLD. The LED_DIM_RATE macro defines the rate at which LED dimming is done. Refer to the *main.h* file for details on various macros used and their usage.

Figure 5-46 and Figure 5-47 show the two different color selection models implemented in the project. The two options are selectable using DO_SATURATION macro defined in *main.h*.

Figure 5-46. Hue and Brightness Control Implementation Model (default model)

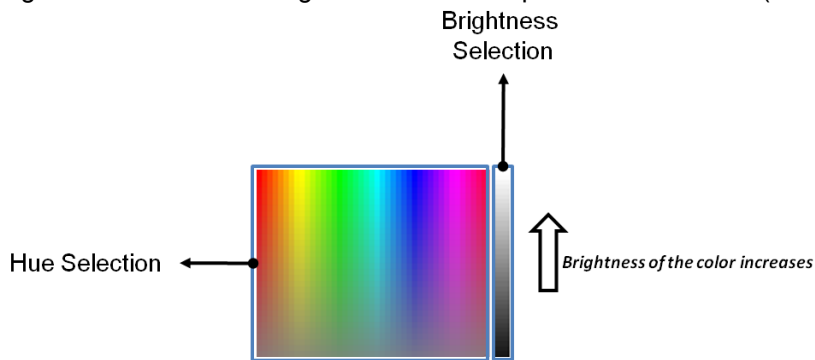

Figure 5-47. Hue, Saturation and Value (HSV) Implementation Model

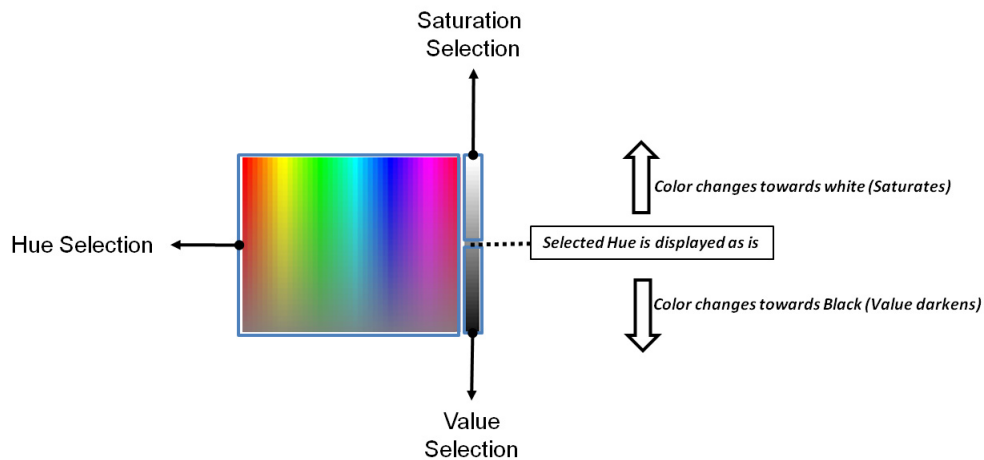

Figure 5-48 through Figure 5-51 explain the process of generating the intensity levels for the RGB LEDs. The color palette and the saturation slider are both part of the Trackpad area. The following steps summarize the flow.

1. The Trackpad coordinates are obtained as shown in the mapping in Figure 5-48. Figure 5-49 shows various macro definitions used in the firmware (main.h) with respect to the Trackpad/color palette area.

Figure 5-48. Trackpad Coordinate Selection

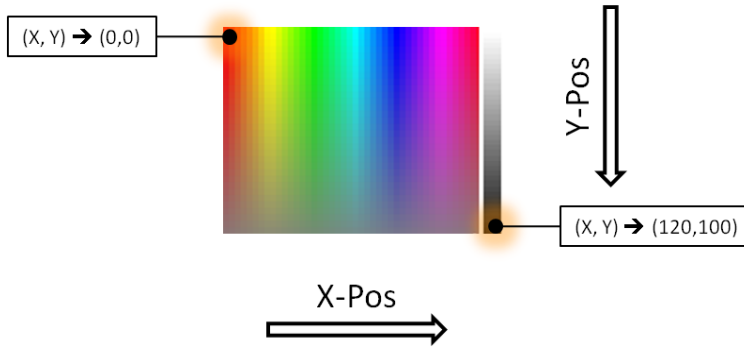
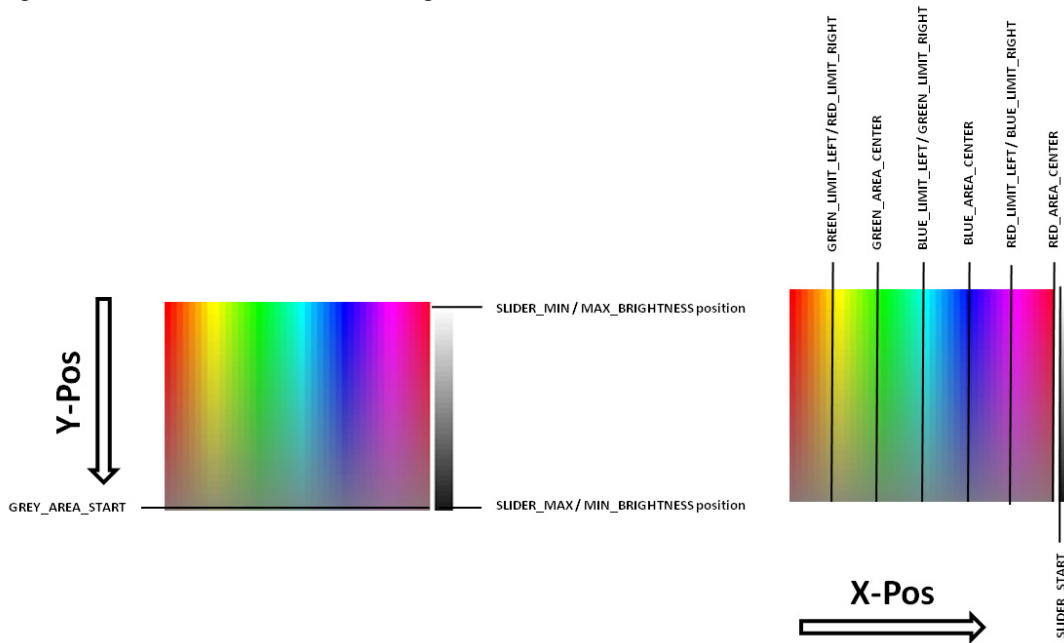

Figure 5-49. Macro Definitions Along X-Y Axis



2. Intensity levels of the RGB colors, before applying saturation, are calculated as shown in Figure 5-50. Along the X-Pos, the color palette is divided into six windows. In each window, one color is at maximum brightness, one is at minimum brightness, and one moves from maximum to minimum or vice versa. The macros shown in Figure 5-49 mark these window boundaries. <color>_AREA_CENTER marks the center of a <color> window on whose either side the <color> will be at maximum intensity. <color>_LIMIT_LEFT/<color>_LIMIT_RIGHT macros mark the edge of each <color>'s area inside which it is at maximum intensity.

Along Y-Pos, each color's intensity moves towards half-intensity level (50 percent) from the intensity level selected along X-Pos (x percent). The color levels are first calculated along the X-Pos using the window rule and X coordinate. The color thus obtained is then processed with the Y coordinate.

Figure 5-50. Intensity Calculation Based on X and Y in Color Palette

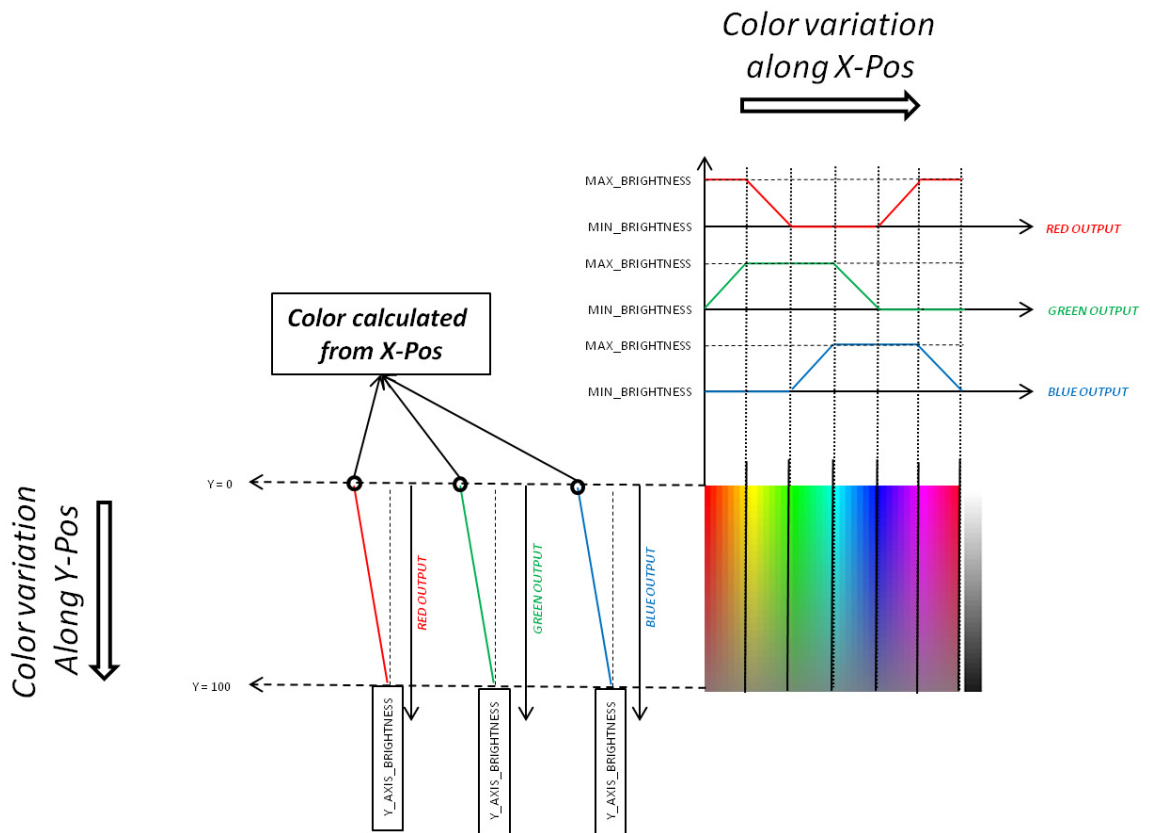

3. After the primary color intensities (from the color palette) are derived from step 2, either the brightness level or the saturation level selected by the slider is applied. The selection between brightness and saturation is done using DO_SATURATION macro defined in *main.h*.
 - a. Disabling/commenting out the DO_SATURATION macro applies brightness control on the color. Brightness control is a simple scaling of the three color intensities, derived at step 2, using slider output. Default brightness value at power on is 100% or maximum.
 - b. Enabling the DO_SATURATION macro applies saturation as explained in [Figure 5-51](#). In saturation control, if the slider output is at half value, the intensities are retained. If it is less than half value, all the intensities move towards the minimum intensity (black/darker). If it is more than half value, all the intensities move towards the maximum intensity (white/brighter). Default saturation value at power ON is 50 percent or HALF_SATURATION value. The amount by which each color darkens or brightens is proportional to the slider position's relative difference from its center. See [Figure 5-51](#).

Figure 5-51. Saturation Calculation Based on Slider Output

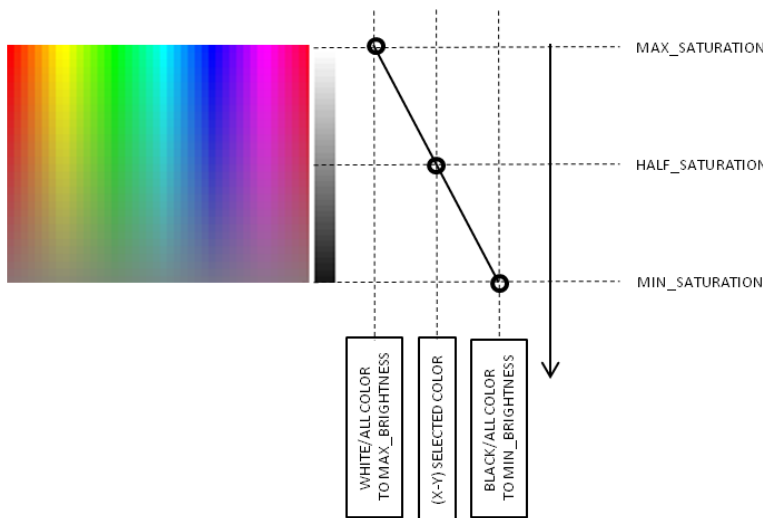

■ Sleep-Scan Mode

In the sleep-scan mode, the firmware scans either the proximity sensor or the gang sensor (sensors in touchpad row elements ganged together) or both. This option is configurable during project compilation by commenting out the ENABLE_PROXIMITY or ENABLE_GANG macros. Keeping both will scan both the sensors in sleep, and disabling both will keep the device in active scanning mode always.

- If a proximity sensor is used in sleep-scan mode and the device detects any proximity activity on the sensor, the device will enter proximity scanning mode.
- If a gang sensor is used in sleep-scan mode and the device detects activity on the Trackpad during its scan, the device enters active scanning mode directly.

The rate at which the device scans in the sleep-scan mode is configurable by changing the macro SLEEP_TIMER_PERIOD defined in *main.h*.

- Proximity Scanning Mode:

In proximity scanning mode, the device primarily scans the proximity sensor, and the touchpad sensors are scanned for activity. The previously selected RGB color is turned on with intensity proportional to the proximity signal strength. The device enters active scanning mode when a Trackpad element is touched. It stays in proximity scanning mode as long as there is some activity on the proximity sensor. If the hand moves out of proximity range, the device will return to sleep-scan mode.

Output Interfaces

- Optional TX Interface

The firmware also features an optional UART TX interface, which can be enabled or disabled based on need. To enable or disable the TX interface, uncomment or comment TX_ENABLE macro present in *main.h*. The firmware also provides an option to select between two types of packets that are transmitted over the TX line. One packet contains the raw count, baseline, and signal data of all the sensors in the system in multichart format (refer to [AN2397](#) for details on the multichart charting tool). Another type of packet sends out just the Trackpad coordinates. To select between these two types of packets, you can use the MINIMAL_TX macro. If the macro is commented out, then the first type of packet is transmitted. If the macro is present, then the second type of packet is sent.

Note: To view the MINIMAL_TX data, you can use BCP (as explained in [UART Data Viewing on page 69](#)) with *CapSense Color Palette (Minimal TX) - Commands.iic* and *CapSense Color Palette (Minimal TX) - Variables.ini* files available under `...\Firmware\PSoc 4\Bridge Files` folder. [AN2397](#)'s Multichart tool can be used to view the first type of packet because of the packet size.

- Software PrISM for LED Intensity Control

The firmware uses a software implemented 7-bit PRS for controlling the LED intensity through Precision Illumination Signal Modulation (PrISM). The implementation uses the SysTick timer available as part of Cortex-M0 CPU subsystem. The SysTick timer generates the interrupt where the PRS computations are performed to generate the Pseudo Random signal at the output of the LED pins. The implementation details can be found in *RGB_PRSm.h* and *RGB_PRSm.c* files available as part of the project. The polynomial used to generate the PRS is fixed to [7,6,5,2]. The period or repeat rate of the PRS is 127 counts. With SysTick timer generating an ISR at 20 kHz, this will result in a ~150 Hz output. Because the output is not a fixed pulse-width signal and is, a high-frequency signal (with a maximum frequency of 10 kHz and average of around 5 kHz), the signal easily gets filtered out avoiding any flickers usually noticed with PWM signals at this frequency.

5.5.2.3 Hardware Connections

The example requires the CapSense Trackpad shield connection, as explained in [Project: CapSense Touchpad with I2C Tuner on page 76](#). The RGB LED and CMOD connections are hard-wired on the board. Optionally, a proximity loop can be connected, as shown in setup 1 in [Figure 5-52](#). To use the firmware efficiently, the proximity loop can be formed as a loop around the Trackpad, as shown in [Figure 5-53](#). With setup 2, the LED turns on to show the previous color as the hand approaches the Trackpad.

Note: For the proximity loop, the wire shipped with the kit (4 inches in length) can be wound to form a loop of 1 to 2 inch diameter; the range obtained will be approximately the same as the loop diameter for a fast approaching hand. To obtain a higher range, use a longer wire/bigger loop.

Figure 5-52. Setup 1

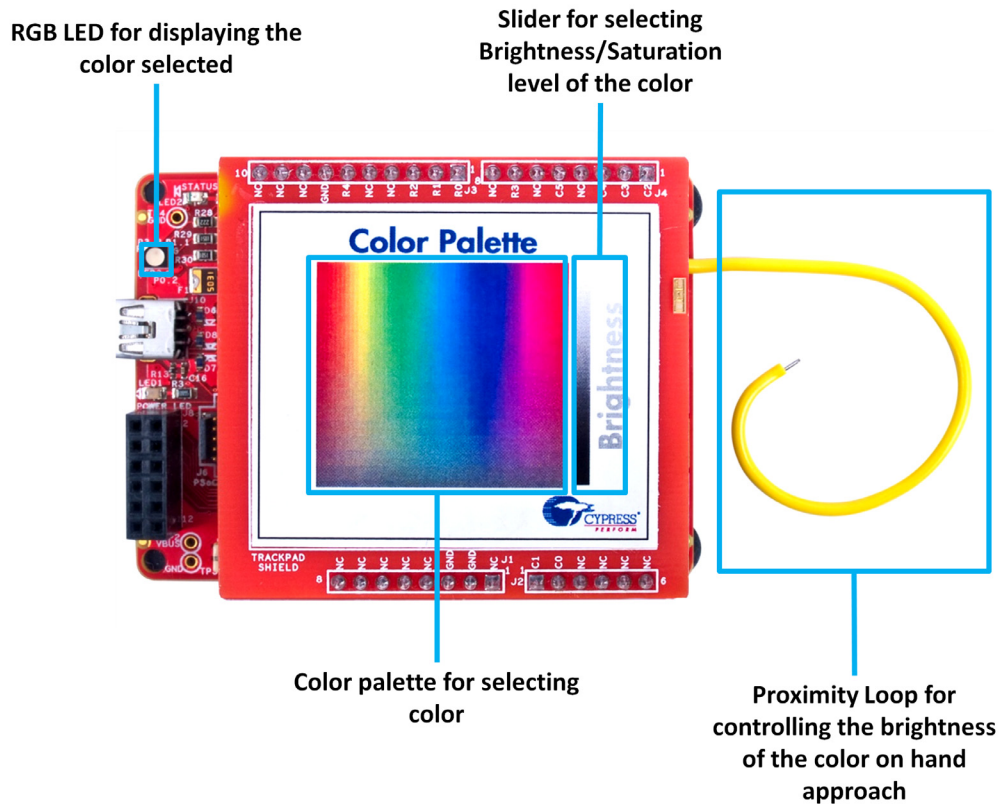
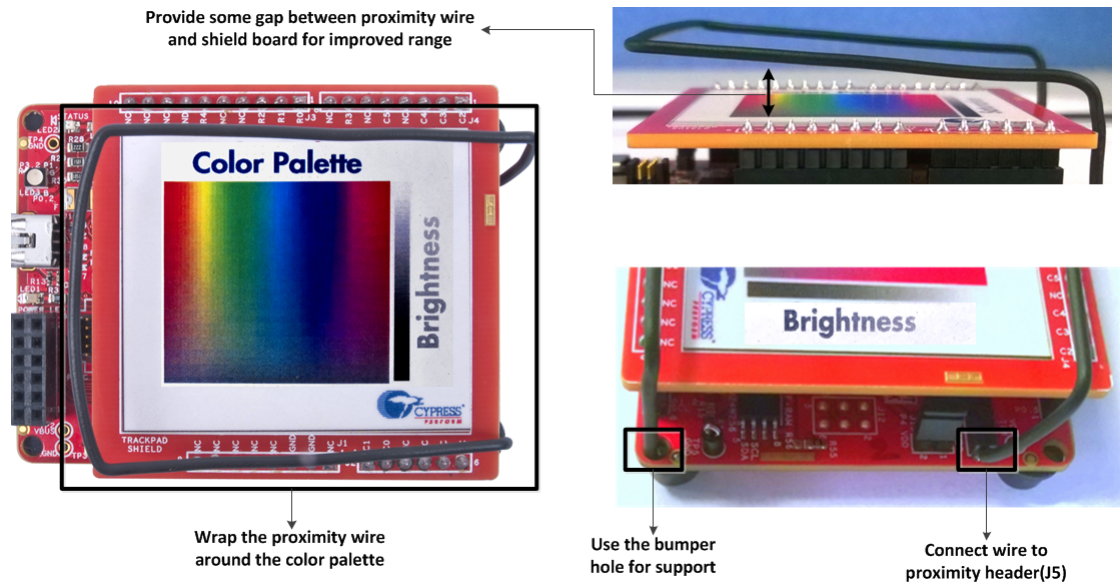

Figure 5-53. Setup 2



Open *CY8CKIT_040_Color_Palette.cydwr* under the **Source** vertical tab in the **Workspace Explorer** and select the suitable pin.

Table 5-13. Pin Connection¹

Pin Name	Port Name
Trackpad_X0	P0_3
Trackpad_X1	P0_7
Trackpad_X2	P0_6
Trackpad_X3	P0_5
Trackpad_X4	P0_0
Trackpad_X5	P0_1
Trackpad_Y0	P1_4
Trackpad_Y1	P1_5
Trackpad_Y2	P1_6
Trackpad_Y3	P1_0
Trackpad_Y4	P1_7
CMOD	P0_4
Proximity	P2_0
Red LED	P3_2
Green LED	P1_1
Blue LED	P0_2
UART TX	P3_0 ²

1. Trackpad_X0 (Touchpad0_Col0_TP) to Trackpad_X5 (Touchpad0_Col5_TP) maps to COL5 to COL0 of the Trackpad so as to make the Trackpad x-axis left aligned.
2. Selected in firmware (refer to main.h)

Figure 5-54. Pin Selection for Color Palette Project

Alias	Name /	Port	Pin
Cmod	\CapSense:Cmod\	P0[4] CSD:c_mod, SRSS:ext_clk, TCPWM:tr_in[4], CSD:comp	5
Touchpad0_Col0_TP	\CapSense:Sns[0]\	P0[3] TCPWM:tr_in[3]	4
Touchpad0_Col1_TP	\CapSense:Sns[1]\	P0[7]	11
Touchpad0_Col2_TP	\CapSense:Sns[2]\	P0[6]	10
Touchpad0_Col3_TP	\CapSense:Sns[3]\	P0[5]	9
Touchpad0_Col4_TP	\CapSense:Sns[4]\	P0[0] TCPWM:tr_in[0]	1
Touchpad0_Col5_TP	\CapSense:Sns[5]\	P0[1] TCPWM:tr_in[1], CSD:comp	2
Touchpad0_Row0_TP	\CapSense:Sns[6]\	P1[4] TCPWM:tr_underflow	16
Touchpad0_Row1_TP	\CapSense:Sns[7]\	P1[5] TCPWM:tr_overflow	17
Touchpad0_Row2_TP	\CapSense:Sns[8]\	P1[6] TCPWM:tr_overflow, TCPWM:line_out_compl, TCPWM:tr_underflow, CSD:comp	18
Touchpad0_Row3_TP	\CapSense:Sns[9]\	P1[0]	12
Touchpad0_Row4_TP	\CapSense:Sns[10]\	P1[7] SRSS:ext_clk, TCPWM:tr_compare_match	19
ProximitySensor0_0_PROX	\CapSense:Sns[11]\	P2[0]	20
	RGB_PRSm_Blue	P0[2] CSD:c_sh_tank, TCPWM:tr_in[2]	3
	RGB_PRSm_Green	P1[1] TCPWM:line_out	13
	RGB_PRSm_Red	P3[2] TCPWM:line_out	23

5.5.3 Verify Output

Build and program the code example onto the device. The default color for the RGB LEDs is blue. Therefore, when you move over the proximity sensor before touching the Trackpad, the RGB LED turns blue. Follow these steps to verify the code.

1. Touch the color palette on the Trackpad, as shown in [Figure 5-55](#). The color touched will be displayed in the RGB LEDs.

Note: Because the LED is bigger (compared to pixels in displays and paper), the individual color/LED may be visible at some points. An extra diffuser such as a thin paper can be placed on top of the RGB LED, to see proper color mixing. In addition, the LEDs can exhibit different maximum brightness levels depending on the maximum current that can flow through them and the maximum luminosity they can generate (brightness = current × luminosity-to-current-ratio). For instance, red can be brighter than blue for a given series resistance, because of higher luminosity to current ratio and lower voltage drop across them, which results in higher current. For such cases, the brighter color's intensity can be limited to ensure proper mixing. An example for the same is also presented in the example project by limiting the intensity of the red LED to ~85 percent.

Note that when the brightness slider is set to minimum/zero brightness, touches on the color area are not displayed on the LED.

Figure 5-55. Color Palette Output in Active Scanning Mode

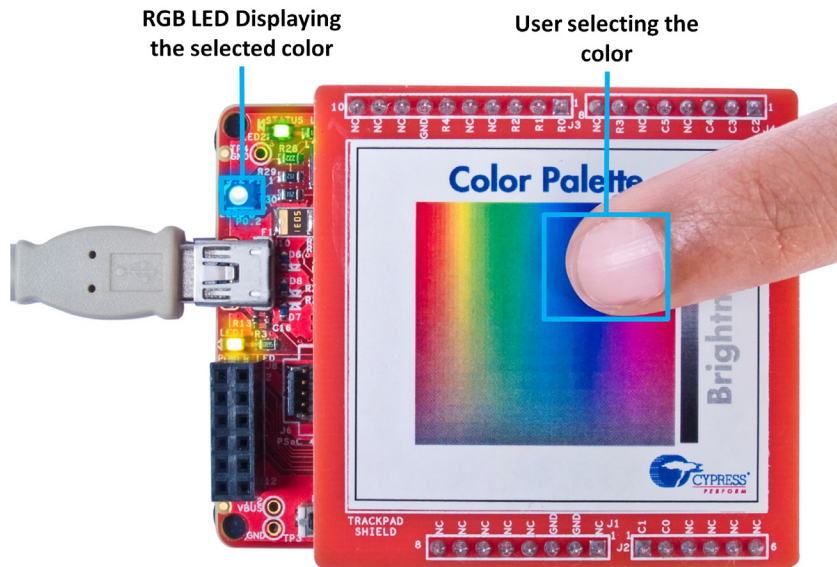

2. Move through the slider area provided at the right corner of the Trackpad to adjust the brightness level of the color. Observe the color varying from Off to full brightness from one end to other.

Note: When moving from the color selection area to the slider area, remove your finger from the Trackpad and place it back on the slider for it to work normally. This is implemented to prevent accidental touches to the slider area when selecting color near the slider area.

3. Move away from the Trackpad and observe the color shown in the LED gradually ramp down after 2-3 seconds and go off after approximately 5 seconds.

- When the LEDs are off, moving your hand towards the proximity loop will slowly ramp up the brightness of the LED as the hand enters the proximity range, and brightness will be at the maximum when it is near the Trackpad. The color on the LED will be the previously selected Trackpad color, as shown in [Figure 5-56](#).

Figure 5-56. Color Palette Output in Proximity Scanning Mode

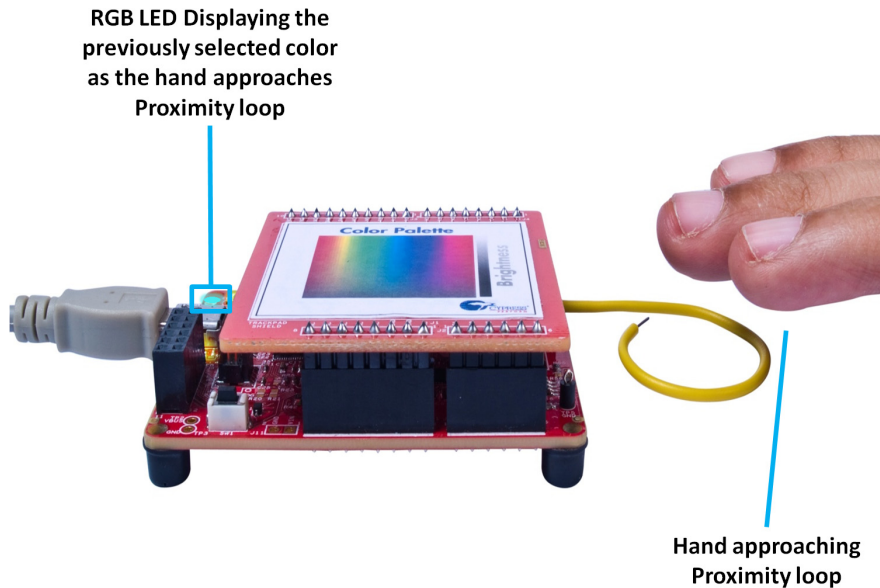

5.6 ADC in PSoC 4000

Starting with PSoC Creator 3.2, an ADC component (CSD_ADC) for PSoC 4000 family is included in component catalog. There are two examples that are included with PSoC Creator to get started with the component. Both the examples make use of CY8CKIT-040 and some external passive components (resistors and wires) for the implementation. This section provides info on how to access the code example and use it with CY8CKIT-040. **ADC_VoltageInp** example is used in the section as reference for explanation.

5.6.1 Using PSoC Creator Code example: ADC_VoltageInput

Follow these steps to open and use the PSoC Creator CSD_ADC code example.

- Launch PSoC Creator from **Start > All Programs > Cypress > PSoC Creator <version> > PSoC Creator <version>**. Note that the CSD_ADC component is supported in PSoC Creator 3.2 or higher.

- On the **Start** page, click **Find Example Project...** under **Examples and Kits**, as shown in [Figure 5-57](#).

Figure 5-57. Open Code Example from PSoC Creator

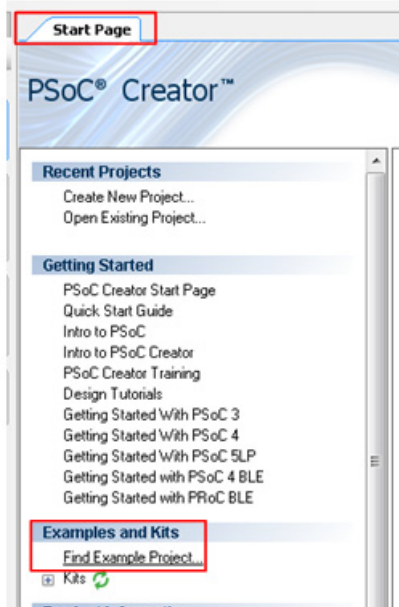

- In the **Find Example Project** window, set the **Device family** to **PSoC 4000** and **Keyword** to **CSD_ADC** as shown in [Figure 5-58](#).

Figure 5-58. Setting the Find Example **Filter Options** and Selecting **ADC_VoltageInp** example

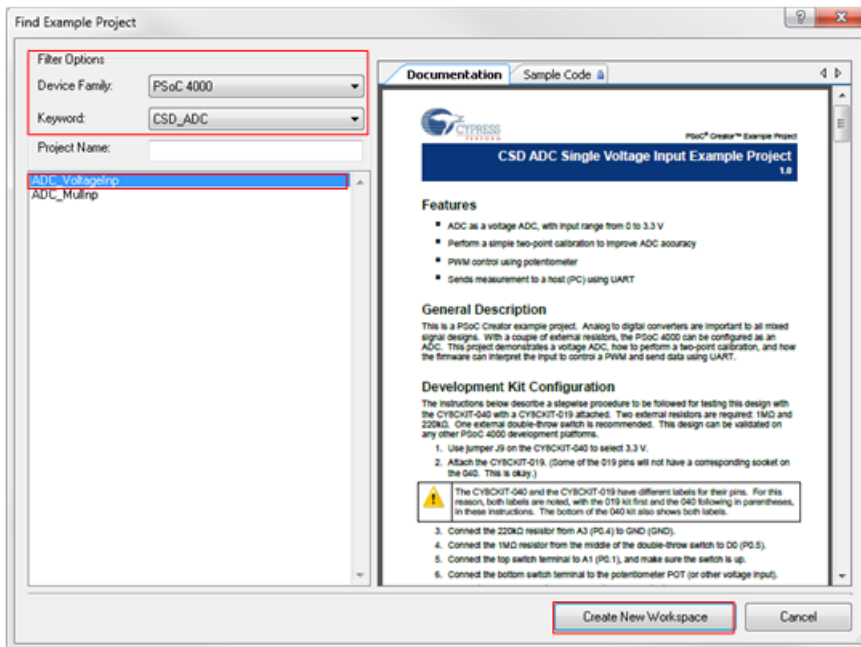

- Two examples for **CSD_ADC** list as shown in [Figure 5-58](#). We will select the **ADC_VoltageInp** example for reference.

5. Select **ADC_VoltageInput** and click the **Create New Workspace** button. Save the workspace to a desired location.
6. This example demonstrates a voltage ADC implementation in PSoC 4000. The example also explains how to perform a two-point calibration for improved accuracy. The firmware controls a PWM output based on ADC output and the ADC data is sent out through UART as well. To learn more about the project, refer to the **ADC_VoltageInput.pdf** file that opens when creating the project. The file is also available in the **Workspace Explorer** see [Figure 5-59](#).

Figure 5-59. Project Datasheet for ADC_VoltageInp Example

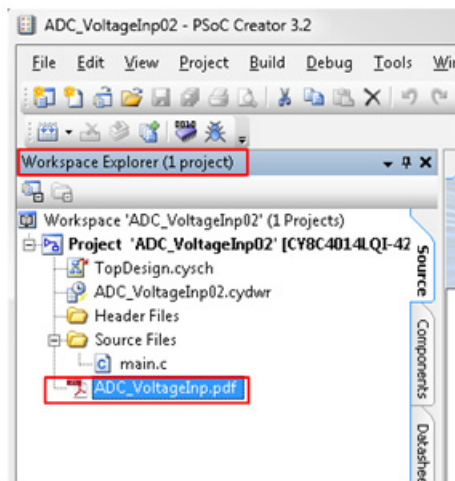

7. The example project is already tested with CY8CKIT-040; follow the **Development Kit Configuration** section in the **ADC_VoltageInput.pdf** file for configuring the kit to use with the example. Note that the current implementation of the CSD_ADC component uses the CapSense hardware. Hence simultaneous use of CapSense along with ADC is not possible. Refer to the CSD_ADC component datasheet for details.

6. Advanced Topics



This section describes some of the advanced features available in the kit.

Note: For all the new example projects created in this section, please rename the components as shown in associated component screen shots/figures. This is required as the .C files attached with the user guide follow the component names as shown in screen shots.

6.1 Using PSoC 5LP as a USB-I²C Bridge

The PSoC 5LP serves as a USB-I²C bridge, which can be used to communicate with the USB-I²C software running on the PC.

Note: Section [Project: CapSense Touchpad with I2C Tuner on page 76](#) also uses the USB-I²C bridge available in the kit, but with the CapSense Tuner window.

The following steps describe how to use the USB-I²C bridge to communicate between the BCP and the PSoC 4.

1. Create a new project targeting the PSoC 4 device in PSoC Creator, as shown in [Figure 6-1](#).

Figure 6-1. Create a New Project in PSoC Creator

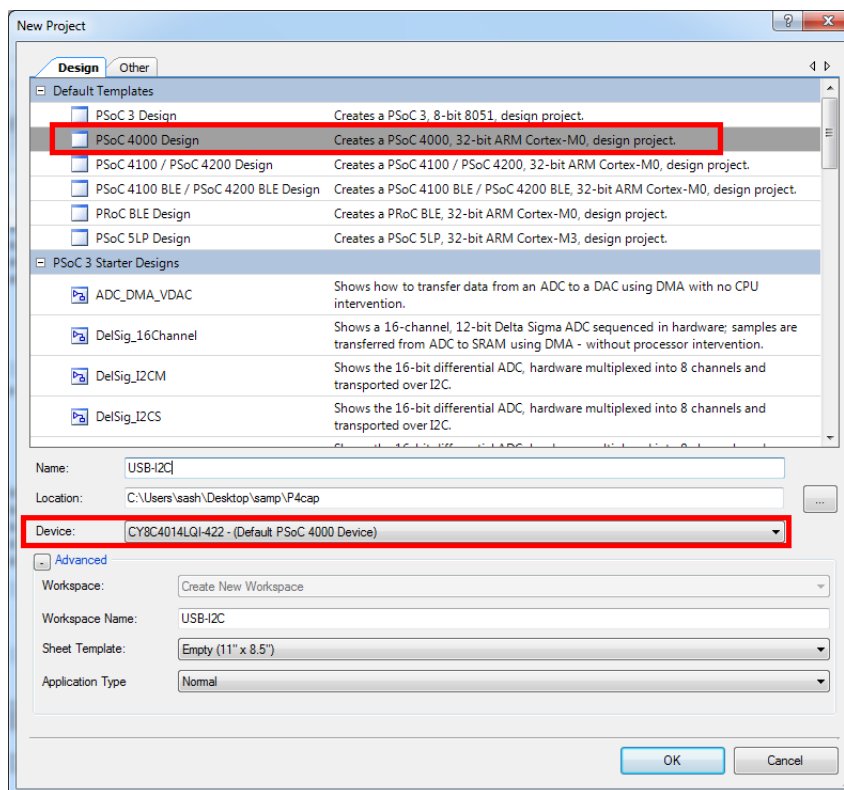

2. Drag and drop an I²C Component to the top design, as shown in Figure 6-2.

Figure 6-2. I²C Component in Component Catalog

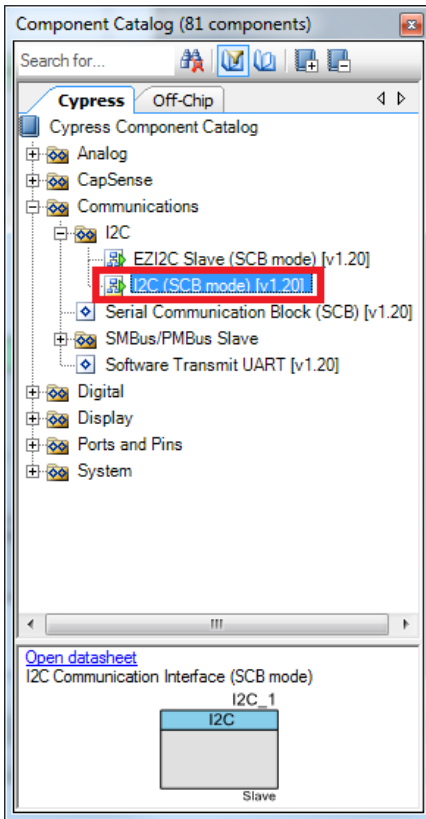

3. To configure the I²C Component, double-click or right-click the I²C Component and select **Configure**, as shown in Figure 6-3.

Figure 6-3. Open I²C Configuration Window

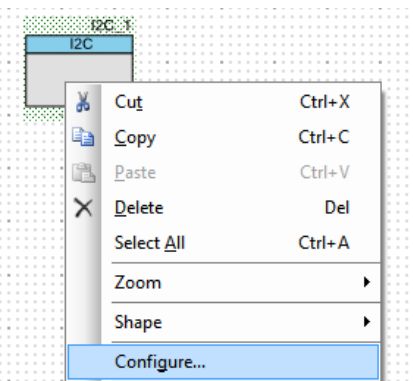

4. Configure the I²C with the settings and click **OK**, as shown in [Figure 6-4](#) and [Figure 6-5](#).

Figure 6-4. I²C 'Configuration' Tab

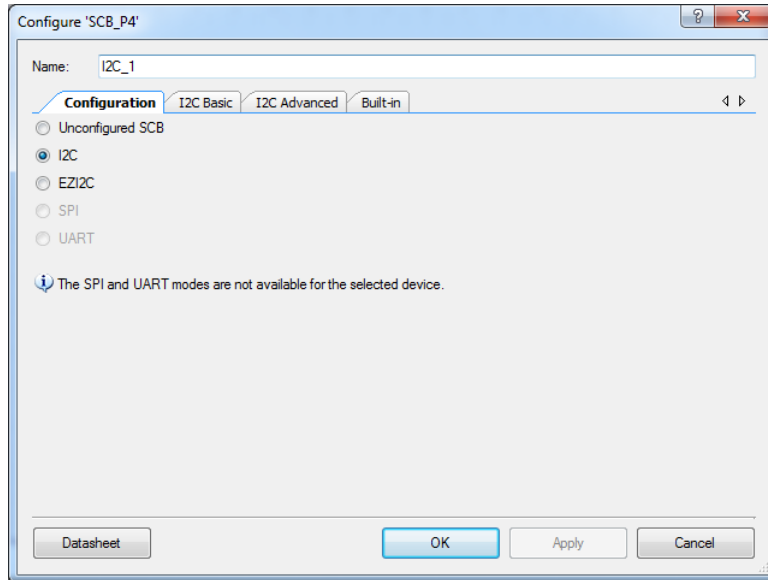
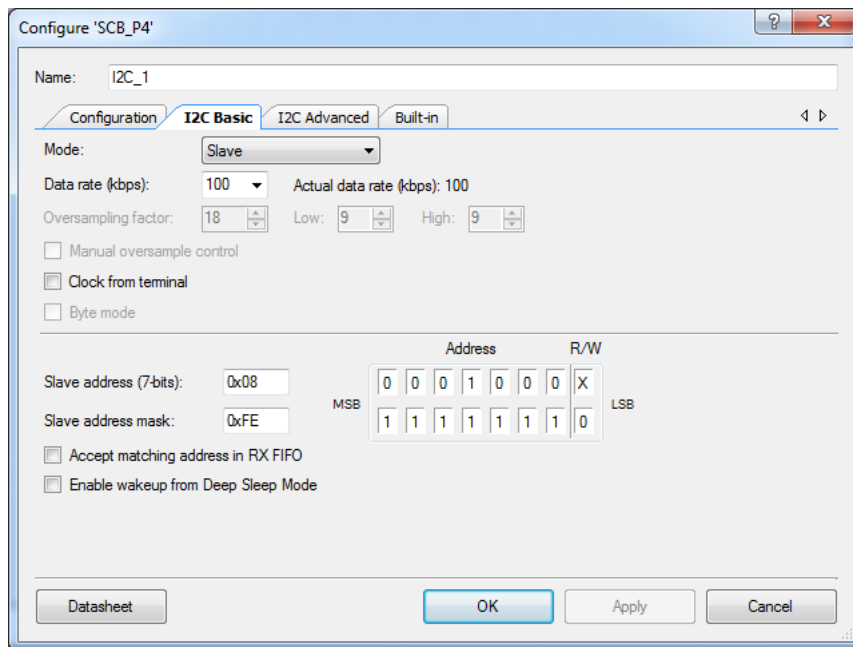
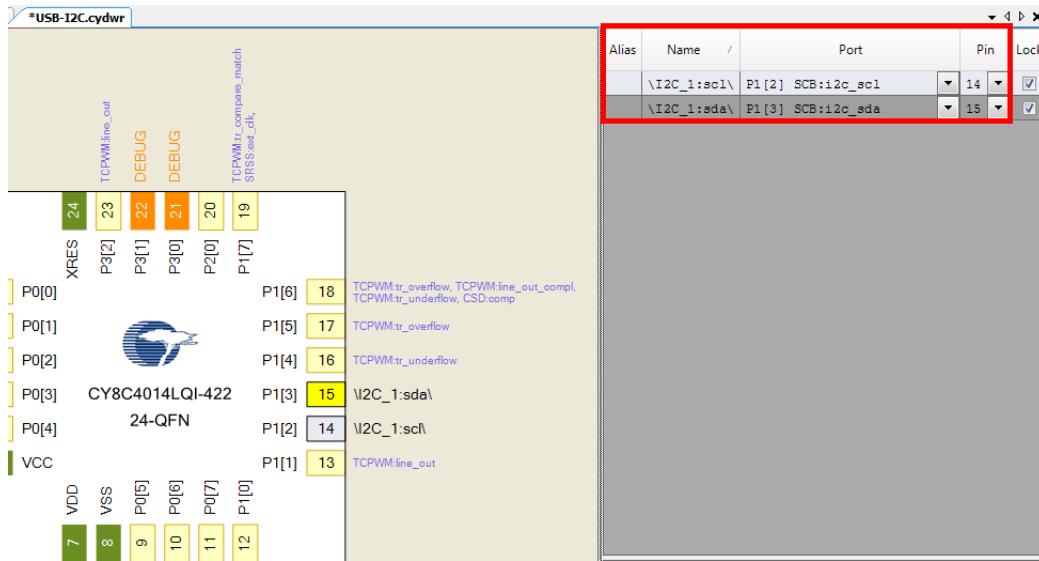

Figure 6-5. 'I²C' Tab



5. Select pin P1[2] for the I²C SCL and pin P1[3] for the I²C SDA in the Pins tab of <project.cydwr>, as shown in Figure 6-6.

Figure 6-6. Pin Selection



6. Place the code available in *USB_I2C-main.c*, which is attached to this PDF document, in your *main.c* project file. This code enables the PSoC 4 device to transmit and receive I²C data to and from the BCP application.

- Build the project by choosing **Build > Build Project** or pressing **[Shift] [F6]**. After the project is built without errors and warnings, program (**[Ctrl] [F5]**) this code onto the PSoC 4 through the PSoC 5LP programmer or MiniProg3.

Note: A warning may be displayed on the I²C input clock. This is because to generate a 100-kbps I²C clock, the block needs a 1.6-MHz signal, which cannot be derived from the default HFCLK setting of 12 MHz. To remove the warning, go to `<project_name>.cydwr > Clocks` and double-click **HFCLK**. Set the **IMO** to **32 MHz** and **HFCLK divider** to **'2'** in the window that appears (see [Figure 6-7](#)). This generates a 16-MHz HFCLK; using a divider of 10, the 1.6-MHz clock required for I²C block will be generated.

Figure 6-7. Clock Settings in cydwr File

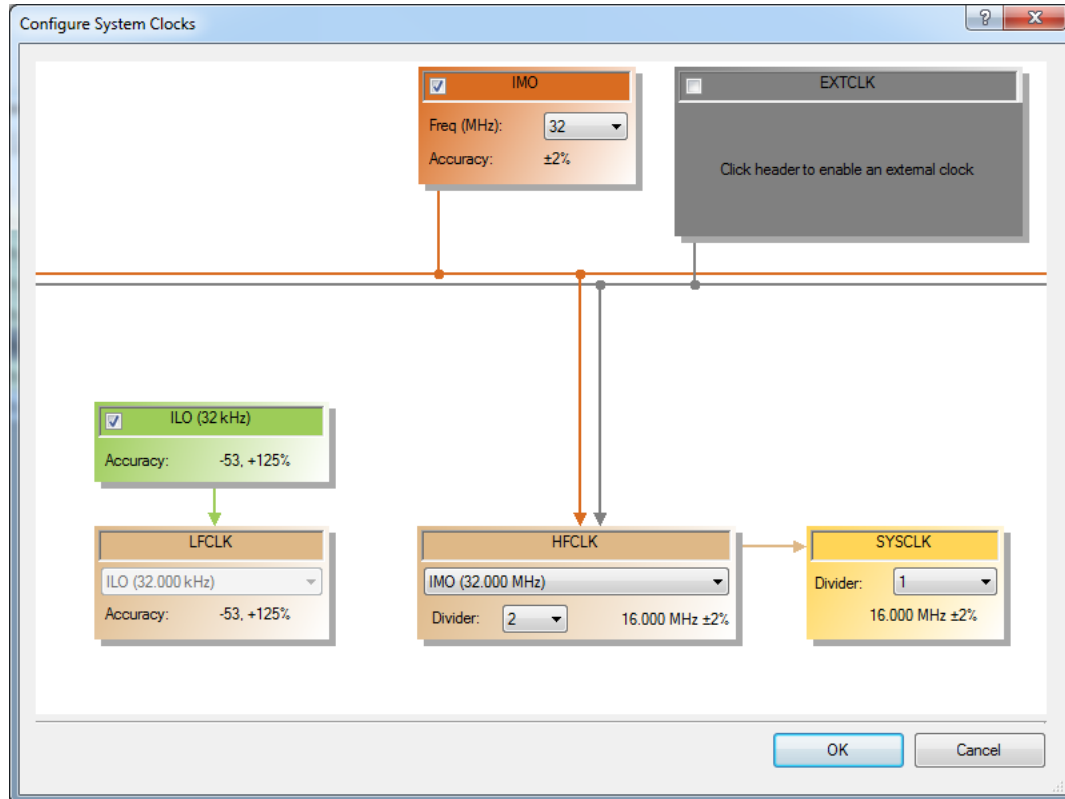

- Open BCP from **Start > All Programs > Cypress > Bridge Control Panel <version number>**.

9. Connect to **KitProg/** under **Connected I²C/SPI/RX8 Ports**, as shown in Figure 6-8.

Figure 6-8. Connect to KitProg/ in BCP

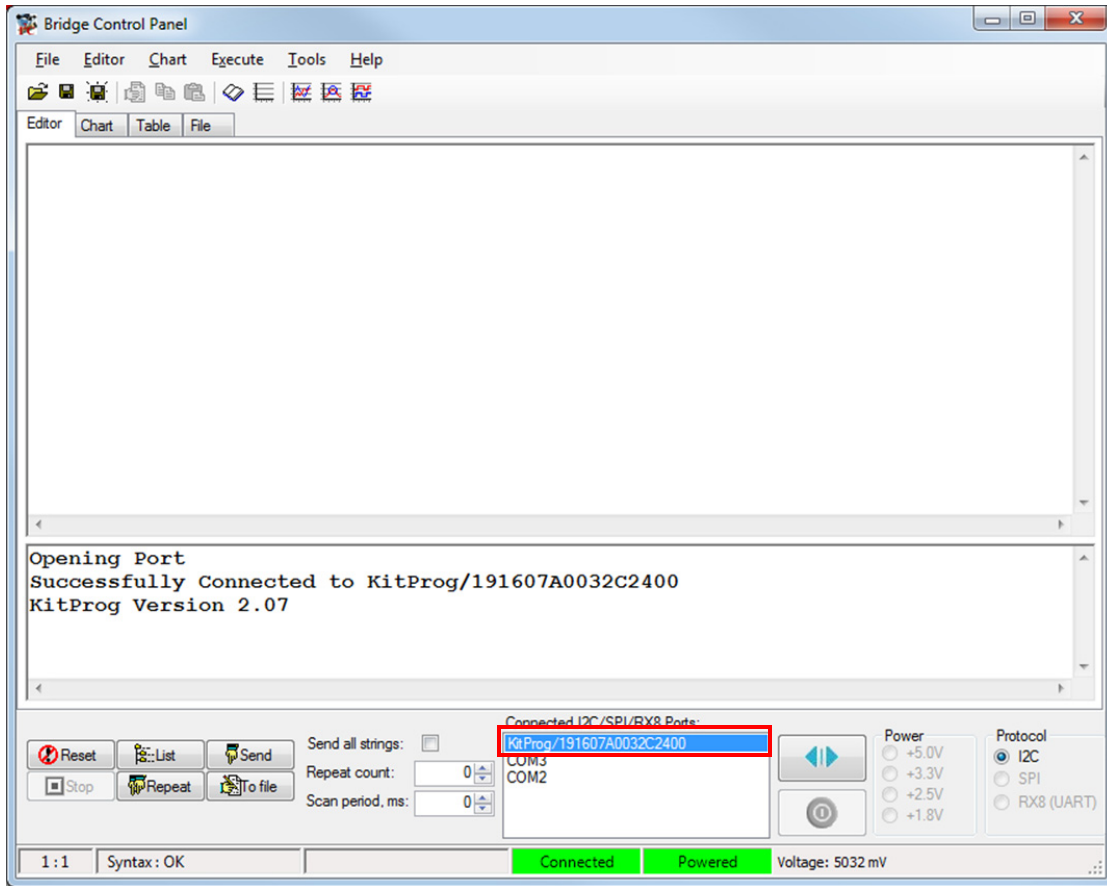

- Open **Protocol Configuration** from the **Tools** menu and select the appropriate **I²C Speed**. Make sure the I²C speed is the same as the one configured in the I²C Component. Click **OK** to close the window, as shown in [Figure 6-9](#).

Figure 6-9. Open Protocol Configuration Window in BCP

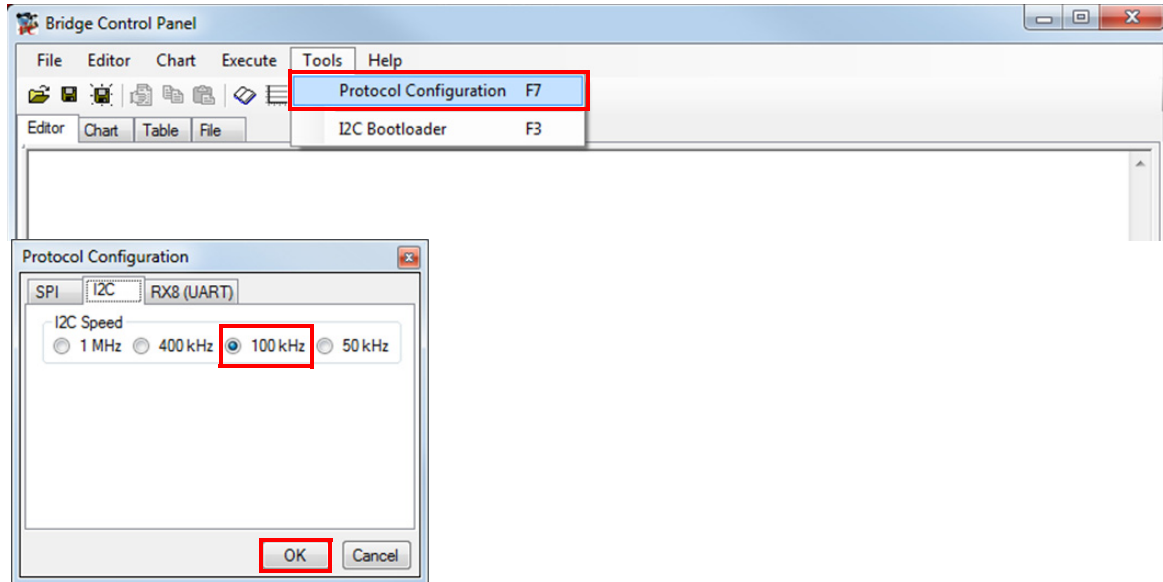

- To transfer data, type the command shown in [Figure 6-10](#) and press **[Enter]** or click the **Send** button in the BCP. The log shows whether the transaction was successful. A "+" indication after each byte indicates that the transaction was successful and a "-" indicates that the transaction was a failure, as shown in [Figure 6-10](#) and [Figure 6-11](#).

Figure 6-10. Enter Commands in BCP

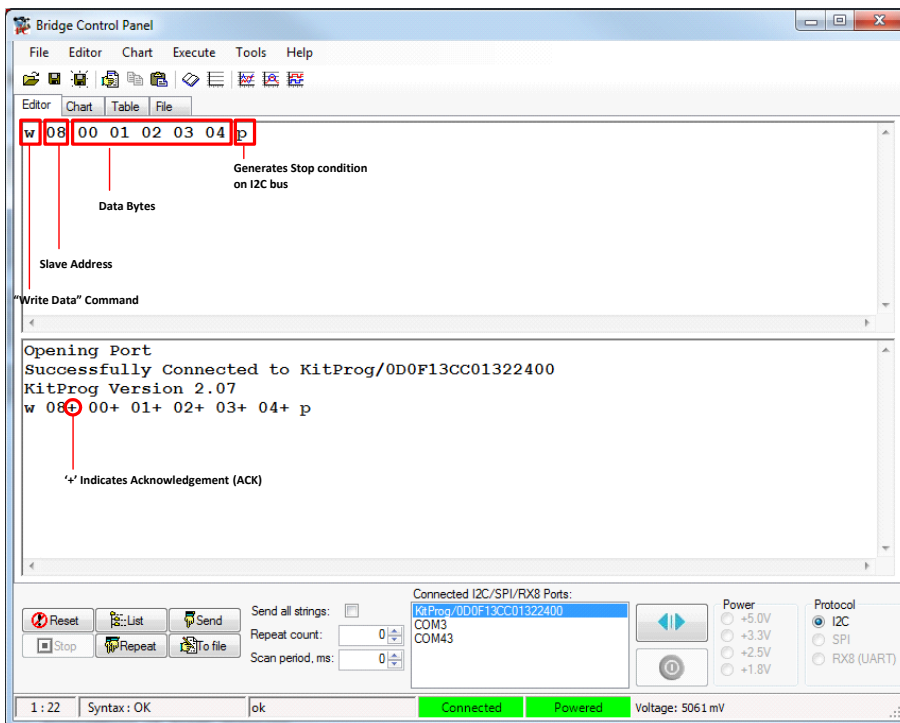
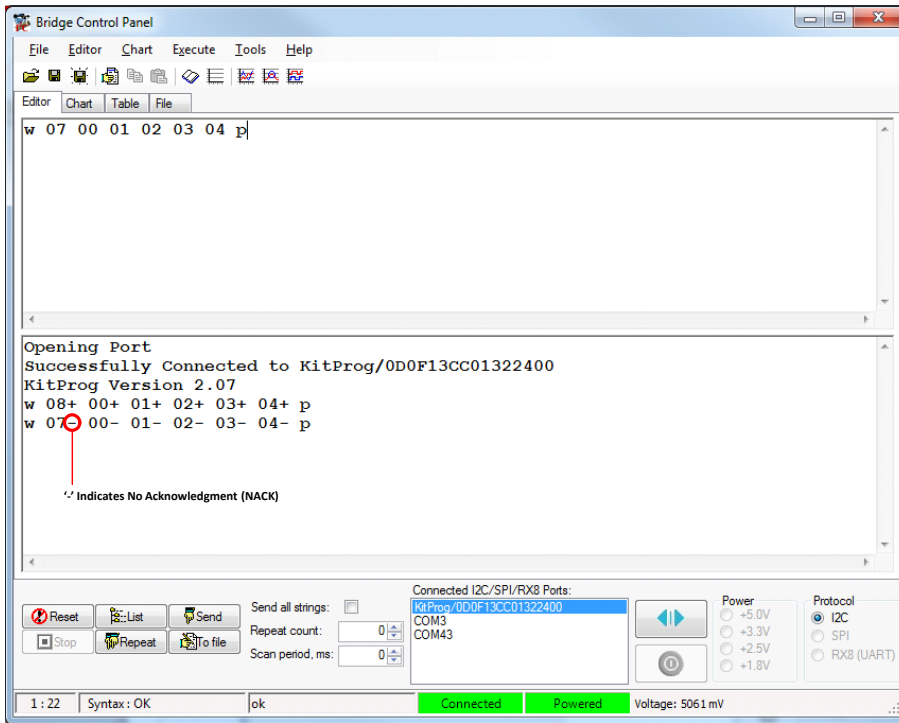
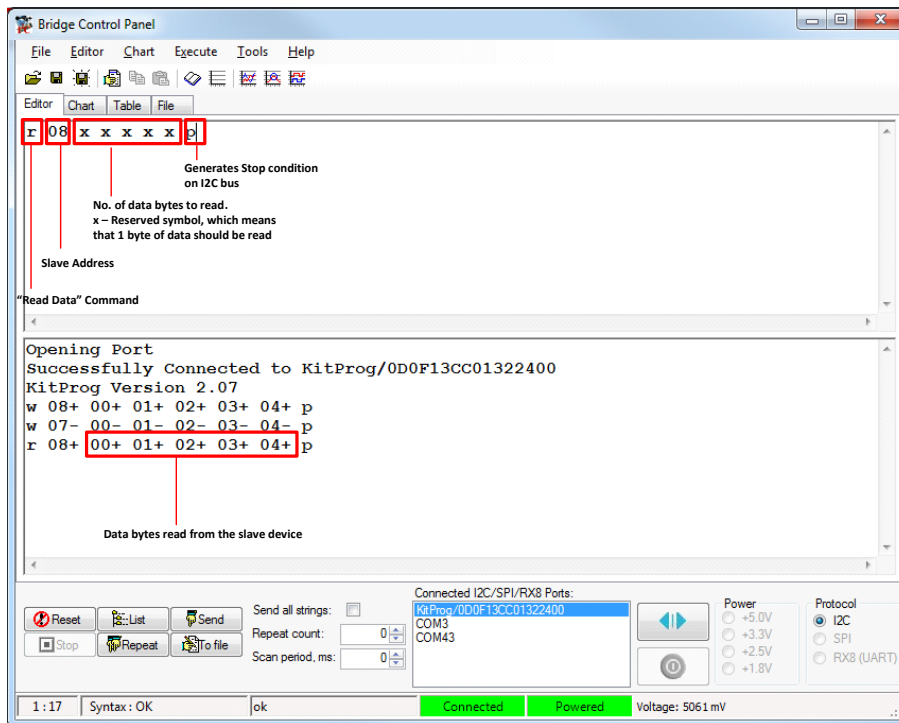

Figure 6-11. NACK Indication in BCP



12. From the BCP, read five bytes of data from the I²C slave device with slave address 0x08, as shown in Figure 6-12. The log shows whether the transaction was successful.

Figure 6-12. Read Data Bytes from the BCP



Note: See **Help Contents** under **Help** in the BCP or press **[F1]** for details of the I²C commands.

6.2 Using FM24W256 F-RAM

The PSoC 4000 Pioneer Kit has an onboard Ferroelectric RAM chip that can hold up to 32 KB of data. Cypress F-RAM products combine the nonvolatile data storage capability of ROM with the benefits of RAM, which include a high number of read and write cycles, high-speed read and write cycles, and low power consumption. F-RAM core memory and integrated products are ideal for applications that require high data integrity and ultra-low power consumption. These products target markets in automotive, industrial, enabling technologies, and networking. F-RAM inherently features high endurance, fast single-cycle, and symmetrical read/write speeds, along with low energy consumption, gamma radiation tolerance, and immunity to electromagnetic noise.

The F-RAM chip provides an I²C communication interface for data access. It is hardwired to the PSoC 4000 I²C lines (P1_2 and P1_3); the same lines are routed to the PSoC 5LP I²C lines as well. Because the F-RAM device is an I²C slave, it can be accessed or shared among various I²C masters on the same line. For more details on the F-RAM device, refer to the [device datasheet](#).

This section describes a simple example on how to set the address of the F-RAM device, use it with an I²C master (PSoC 4000) device, and share the same RAM with the BCP through the PSoC 5LP USB-I²C bridge.

6.2.1 Address Selection

The slave address of the F-RAM device consists of two parts, as shown in [Figure 6-13](#): slave ID and device select. Slave ID is an F-RAM family-specific ID located in the particular F-RAM device data-sheet. For the device used in CY8CKIT-040 (FM24W256-G), the slave ID is 1010b. The device select bits are set using the three physical pins A2-A0 in the device. The setting of these three pins in CY8CKIT-040 is controlled by resistors R19/R18 (A0), R17/R16 (A1), and R15/R14 (A2). See [Cypress Ferroelectric RAM \(F-RAM\) on page 48](#) for details.

Figure 6-13. F-RAM I²C Address Byte Structure

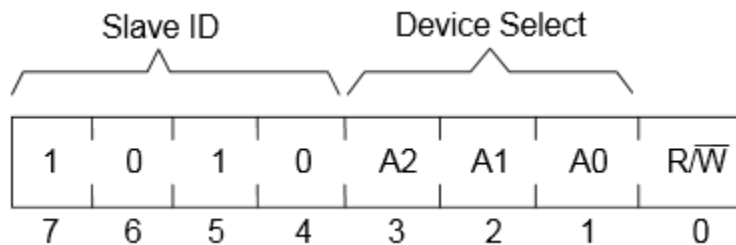

6.2.2 Write/Read Operation

The device's datasheet includes details on how to perform a write/read operation with the F-RAM. [Figure 6-14](#) and [Figure 6-15](#) provide a snapshot of the write/read packet structure as a quick reference.

Figure 6-14. F-RAM Single/Multiple-Byte Write Packet Structure

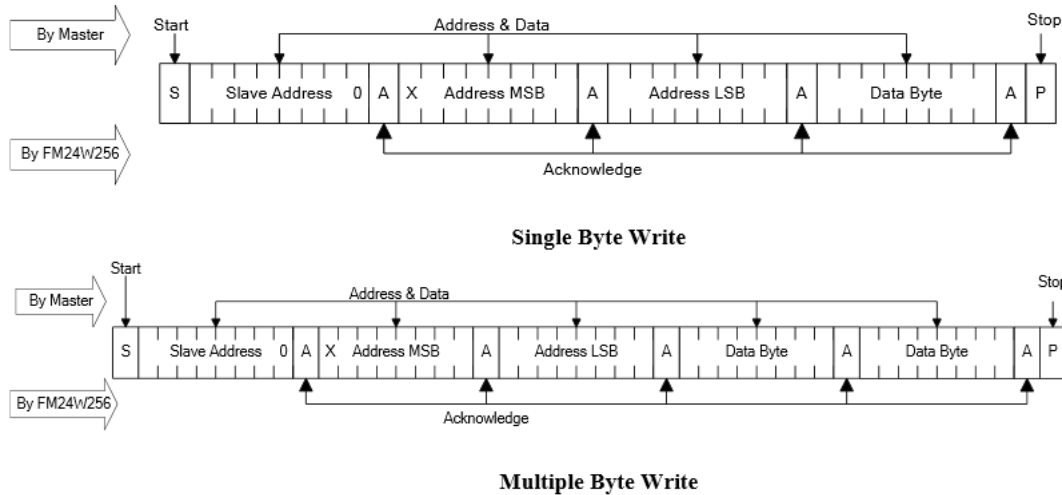
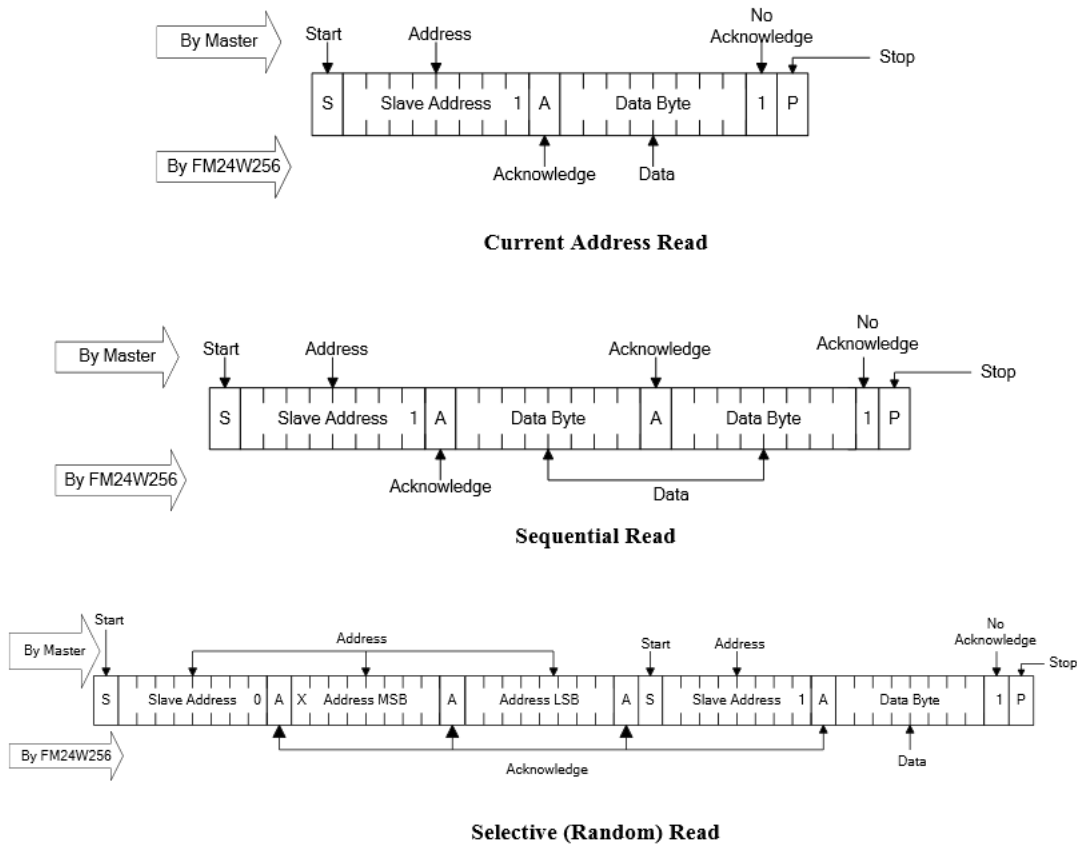

Figure 6-15. F-RAM Single/Multiple-Byte Read Packet Structure



In the previous figures, "Slave Address" denotes the address of the F-RAM slave device. [Address MSB: Address LSB] forms the 16-bit address of the memory location in the F-RAM to be accessed for read/write operation. The first two bytes following the slave address byte during a write operation constitute the initial memory address to be accessed. From there on, each byte accessed (read/write) will increment this address by one and the count wraps around at the boundary (0x7FFF to 0x0000 for a 32 KB device). The value can be reset at any time by doing a write operation with the desired memory address.

6.2.3 Example Firmware

The following steps describe how to create a project with the PSoC 4000 family that uses the onboard F-RAM and shares it with another I²C master (BCP through PSoC 5LP USB-I²C bridge).

1. Open PSoC Creator 3.0 SP1 and create a new PSoC 4000 project, as shown in [Figure 6-16](#).

Figure 6-16. Create a New PSoC 4000 Project in PSoC Creator

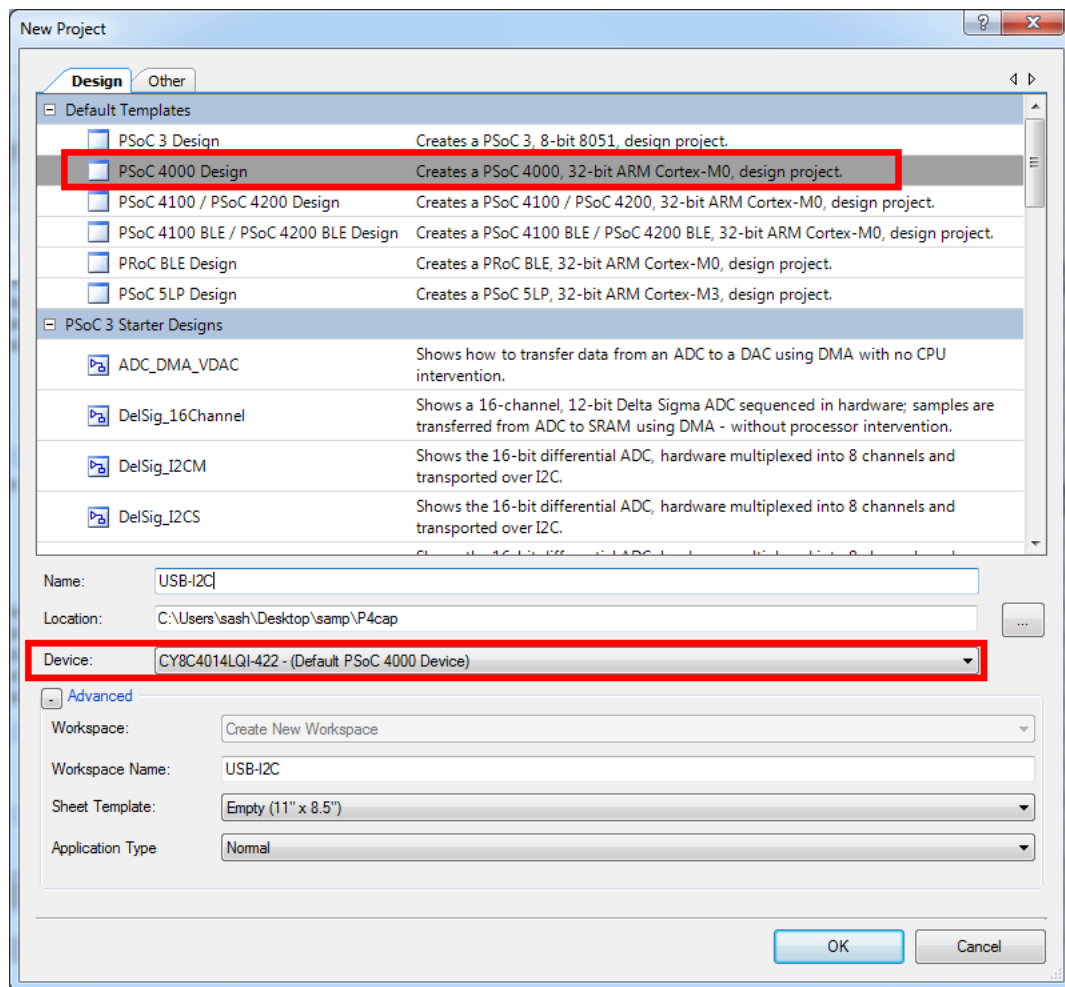

- From the **Components Catalog**, place an **I²C (SCB mode)** Component in the TopDesign from **Communication > I²C > I²C (SCB mode) [<version>]** and configure it as I²C in the **Configuration** tab with the parameters shown in [Figure 6-17](#).

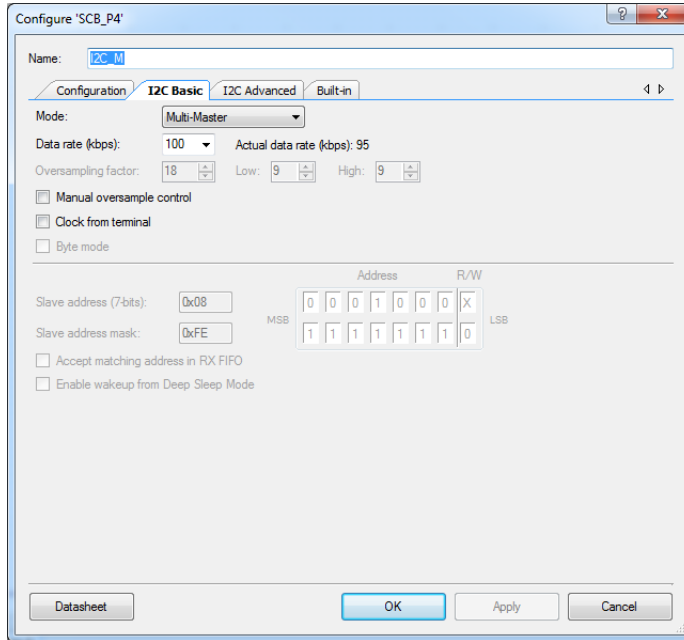
Figure 6-17. I²C Master Configuration

- Select Pins 1[2] and 1[3] as the I²C pins in the **Pins** tab of the .cydwr file, as shown in [Figure 6-18](#).

Figure 6-18. Pin Selection

Alias	Name	Port	Pin	Lock
\I2C_M:scl\	P1[2] SCB:i2c_scl		14	<input checked="" type="checkbox"/>
\I2C_M:sda\	P1[3] SCB:i2c_sda		15	<input checked="" type="checkbox"/>

- Place the code available in *Example_FRAM-main.c*, which is attached to this PDF document, in the *main.c* file.
- Build the project by choosing **Build > Build Project** or pressing **[Shift] F6**. After the project builds without any errors and warnings, program the device by pressing **[Ctrl] F5** through the MiniProg3 or PSoC 5LP programmer in the kit.

Note: A warning may appear on the I²C input clock. This is because to generate a 100-kbps I²C clock, the block needs a 1.6-MHz signal, which cannot be derived from the default HFCLK setting of 12 MHz. To remove the warning, go to `<project_name>.cydwr > Clocks` and then double-click **HFCLK**. Set the **IMO** to **32 MHz** and **HFCLK** divider to '2' in the window that appears (see [Figure 6-7](#)). This generates a 16-MHz HFCLK; using a divider of 10, the 1.6-MHz clock required for I²C block will be generated.

- Open BCP and configure the I²C protocol as defined in [Using PSoC 5LP as a USB-I2C Bridge on page 107](#).

7. In the command window, copy and paste the code from the *F-RAM_BCP_Commands.txt* file attached to this document.
8. By default the F-RAM device is configured with a 0x50 slave address. If the value has been changed as explained in [Address Selection on page 115](#), then change the slave address in the command window (replace “50” with the slave address in hex format).
9. Do a write to the F-RAM device by sending the 'W 50 00 00 01 02' line, which writes to memory location 0x0000 with the value 0x01 and memory location 0x0001 with 0x02. The command sent should be ACKed properly by the slave to make sure the transfer occurred properly, as shown [Figure 6-19](#).

Figure 6-19. Send/Write Data to F-RAM

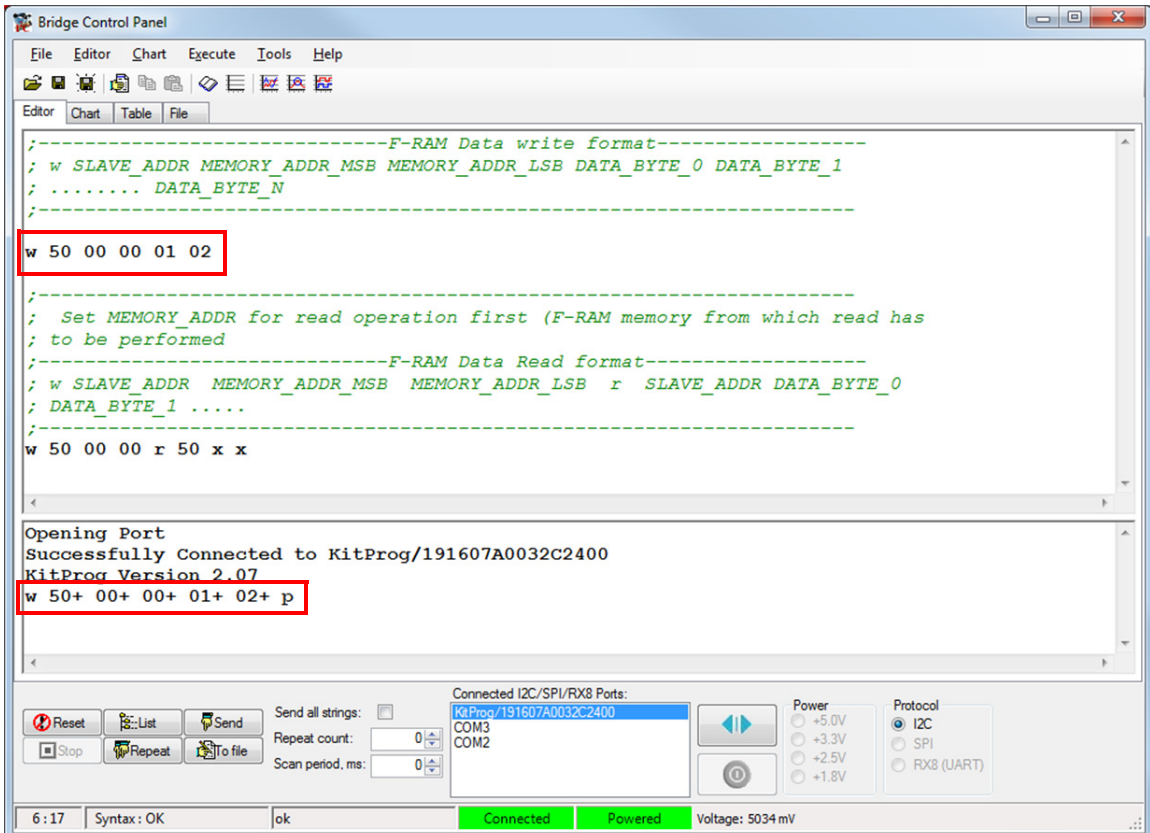

10. If the write transfer is successful, then check back the data using a read command to the same address by sending the second command line, as shown in Figure 6-20. The read command on the same locations will yield a '0' at 0x0000 (flag cleared) and 0xFD at 0x0001 (inverse of 0x02 sent). This shows that the PSoC 4 onboard accessed the bytes and modified them. On writing any byte to 0x0001, as explained in step 9, the inverse of the same will be calculated and stored back at the same location by PSoC 4 if the 0x0000 byte is set to '1'.

Figure 6-20. Read Data From F-RAM

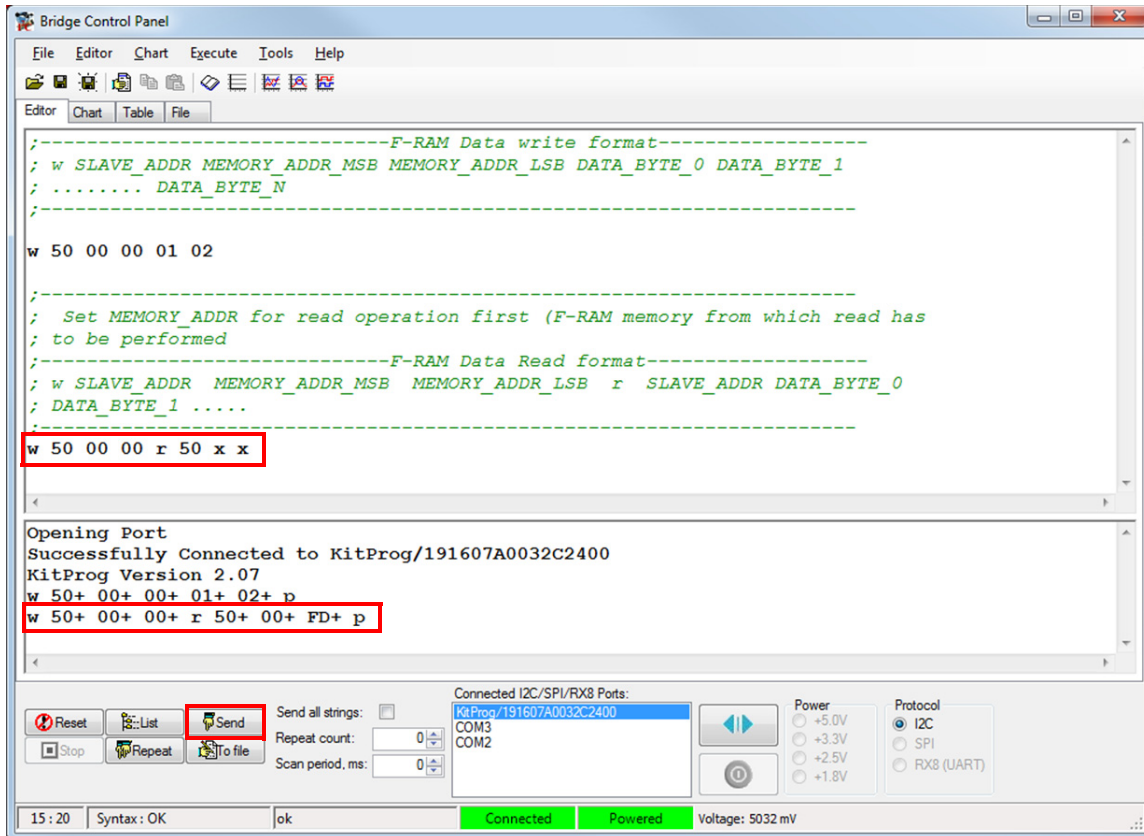

6.3 Using PSoC 5LP as a USB-UART Bridge

The PSoC 5LP serves as a USB-UART bridge, which can communicate with the COM terminal software. This section explains how to use the PSoC 5LP's USB-UART bridge with an external device/board (PSoC 4200 with CY8CKIT-001) with an example.

Note: This project explains how to use the USB-UART bridge of PSoC 5 LP for external UART lines. [Project: CapSense Proximity and UART on page 59](#) can be used as reference for using the USB-UART bridge with the PSoC 4000 family featured on the board. The PSoC 4000 family supports only a software UART transmit line, which is explained in [Project: CapSense Proximity and UART on page 59](#).

Users who have a Windows operating system that does not have HyperTerminal can use an alternative terminal software such as [PuTTY](#).

1. Create a new PSoC 4 project in PSoC Creator, as shown in [Figure 6-21](#). Select an appropriate location for your project and rename it as required.

Figure 6-21. Create a New Project From PSoC Creator

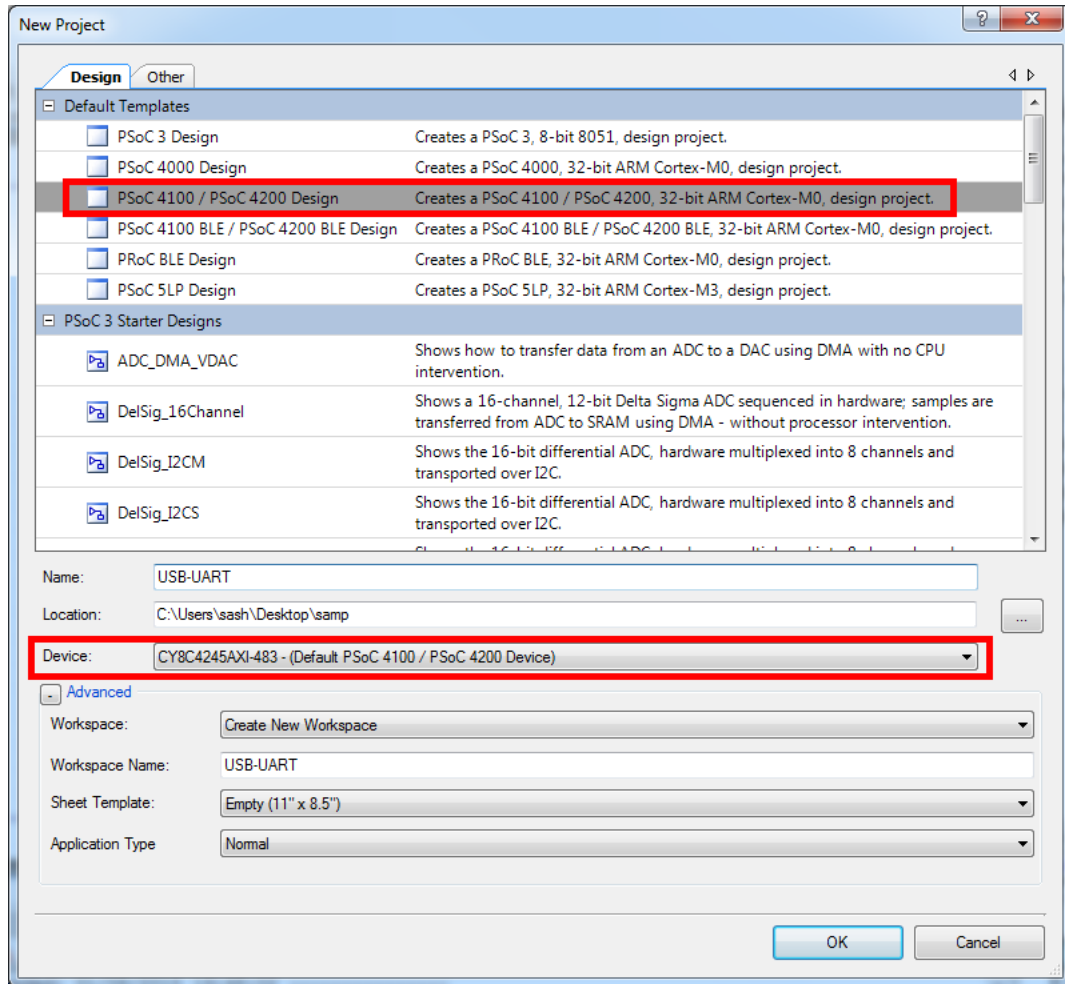

2. Drag and drop a UART (SCB) component from the **Component Catalog** shown in [Figure 6-22](#) to the top design.

Figure 6-22. UART Component Under Component Catalog

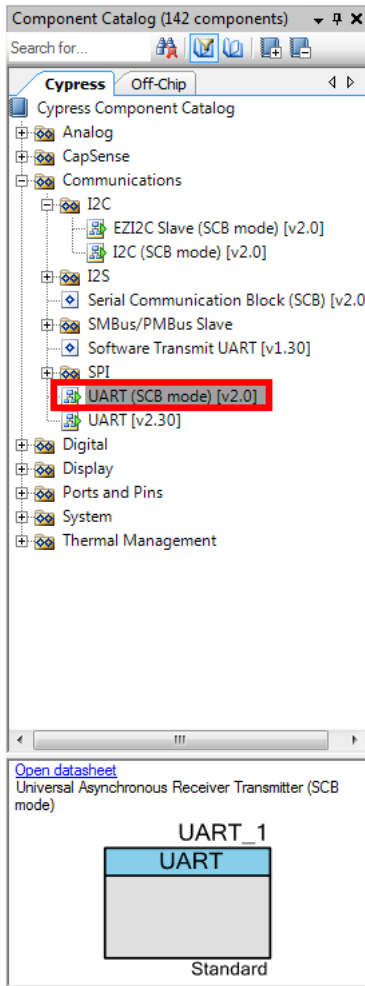

3. To configure the UART, double-click or right-click the UART Component and select **Configure**, as shown in [Figure 6-23](#).

Figure 6-23. Open UART Configuration Tab

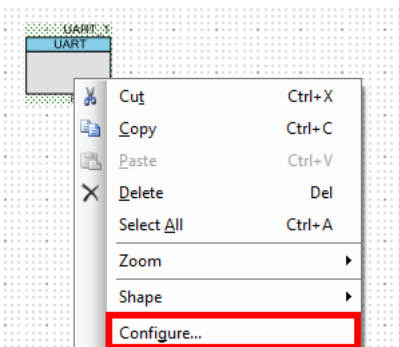

4. Configure the UART as shown in [Figure 6-24](#), [Figure 6-25](#), and [Figure 6-26](#) and then click **OK**.

Figure 6-24. 'Configuration' Tab

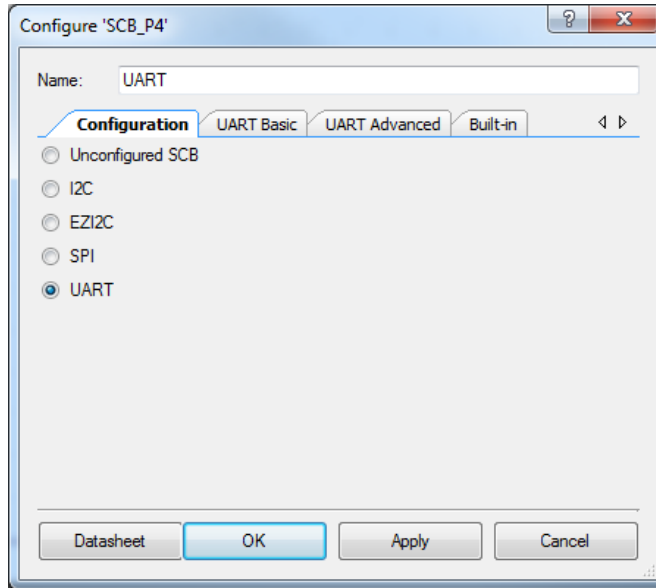

Figure 6-25. 'UART Basic' Tab

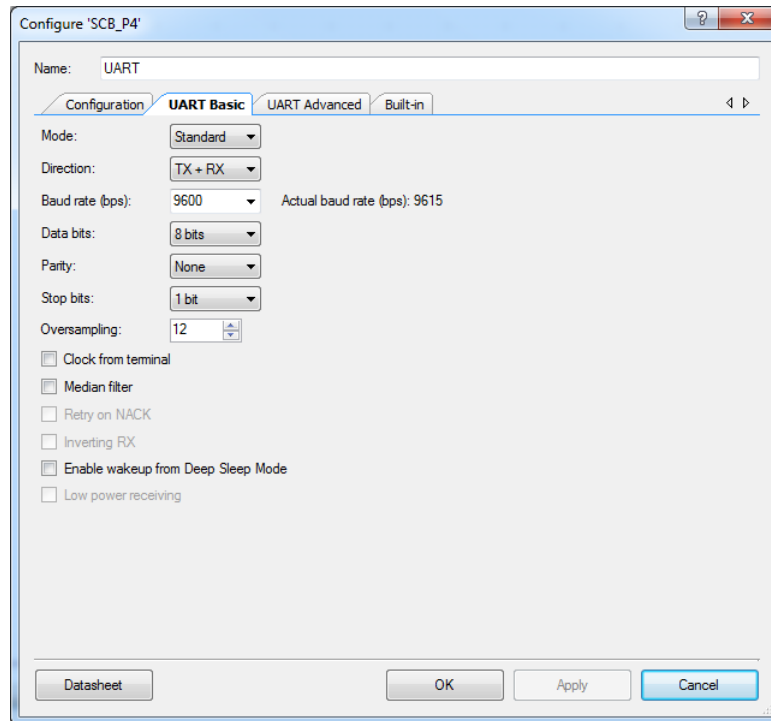
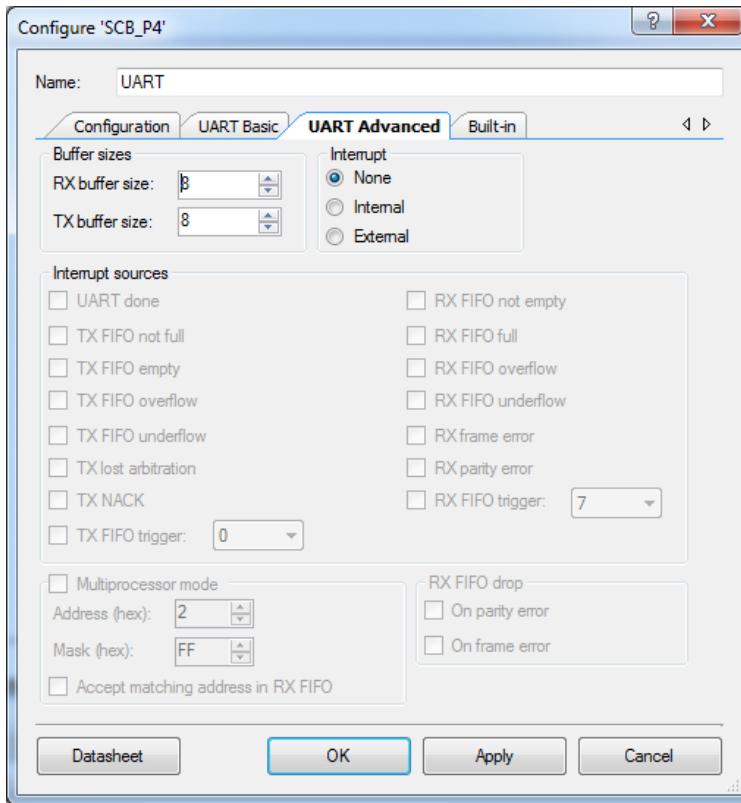

Figure 6-26. 'UART Advanced' Tab



5. Select P4[0] for UART RX and P4[1] for UART TX in the **Pins** tab of `<Project_Name>.cydwr`, as shown in [Figure 6-27](#).

Figure 6-27. Pin Selection

Alias	Name /	Port	Pin	Lock
\UART:rx\	P4[0] SCB0:uart_rx, SCB0:i2c_scl, SCB0:spi_mosi		20	<input checked="" type="checkbox"/>
\UART:tx\	P4[1] SCB0:uart_tx, SCB0:i2c_sda, SCB0:spi_miso		21	<input checked="" type="checkbox"/>

6. Place the code available in `USB_UART-main.c`, which is attached to this PDF document, in your `main.c` project file. The code will echo any UART data received.
7. Build the project by choosing **Build > Build {Project Name}** or pressing [Shift] [F6]. After the project is built without errors and warnings, program (by choosing **Debug > Program**) the project to PSoC 4 through MiniProg3.

8. Connect the RX line of the PSoC 4 to J8_10 and the TX line of the PSoC 4 to J8_9, as shown in Figure 6-28 and Figure 6-29.

Notes:

- Before connecting the RX line, remove R57 connecting P3[0] of the PSoC 4000 device to the PSoC 5LP RX line. This makes sure the PSoC 4000 device can be programmed/debugged while using the RX line for external bridge.
- The setup with CY8CKIT-001, CT8CKIT-038, and CY8CKIT-040 is provided for reference only on how to use the USB-UART bridge for connecting to an external UART interface.

Figure 6-28. UART Connection Between PSoC 4 and PSoC 5LP

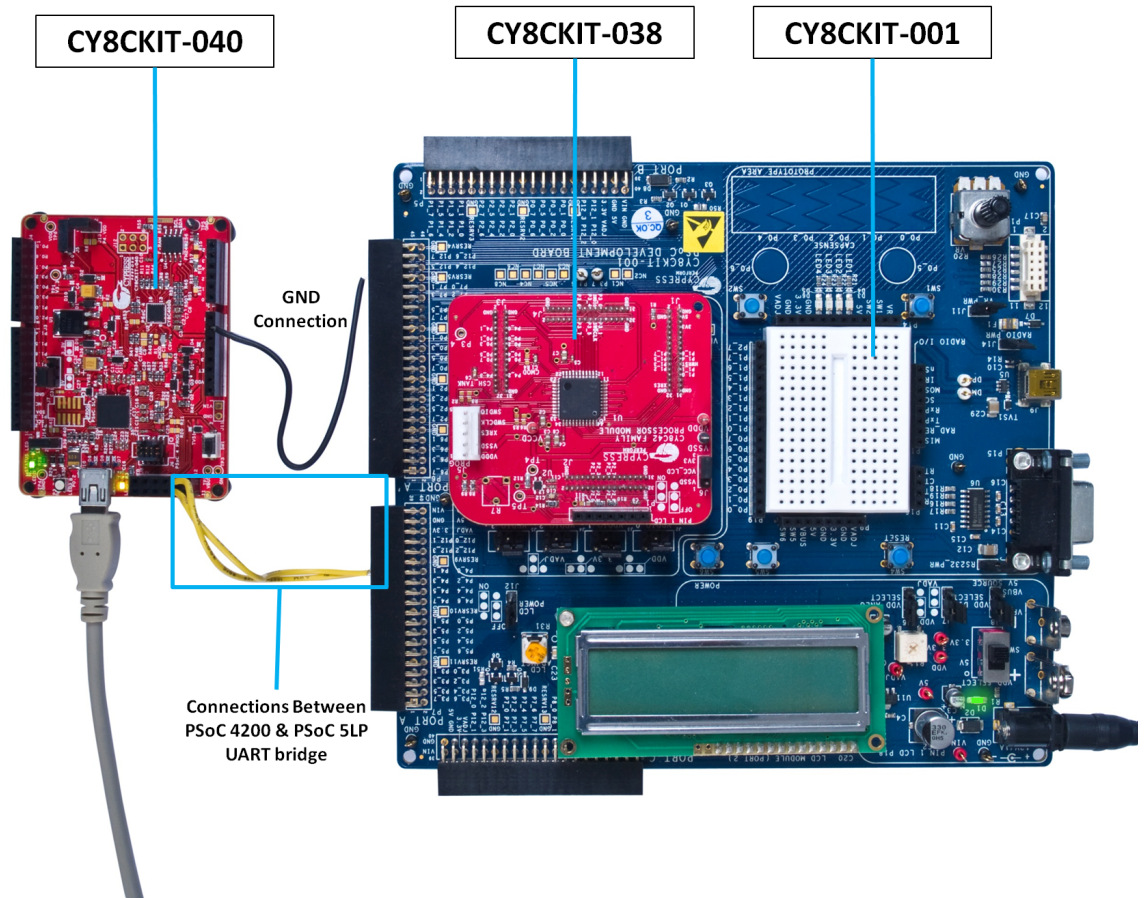
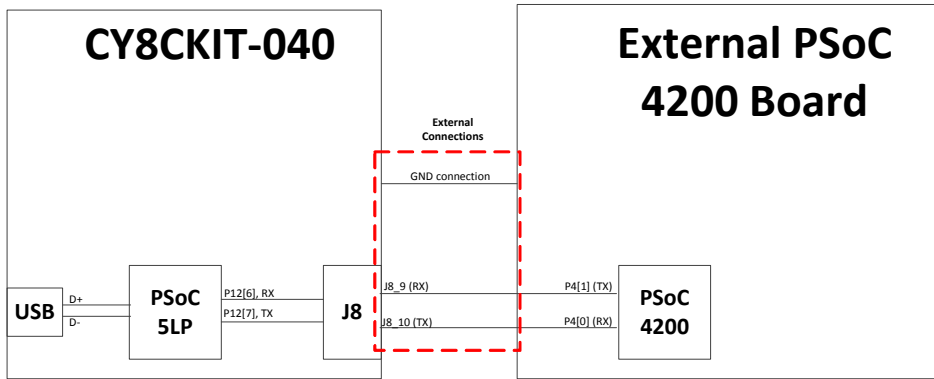

Figure 6-29. Block Diagram of UART Connection Between PSoC 4 and PSoC 5LP



Note: UART RX and UART TX can be routed to any digital pin on PSoC 4 based on the configuration of the UART Component. An SCB implementation of the UART will route the RX and TX pins to either one of the following subsets: (P0[4], P0[5]) or (P3[0],P3[1]) or (P4[0],P4[1]).

To communicate with the PSoC 4 from the terminal software, follow this procedure:

1. Connect USB Mini-B to J10. The kit enumerates as a KitProg USB-UART and is available in the **Device Manager**, under **Ports (COM & LPT)**. A communication port is assigned to the KitProg USB-UART, as shown in [Figure 6-30](#).

Figure 6-30. KitProg USB-UART in Device Manager

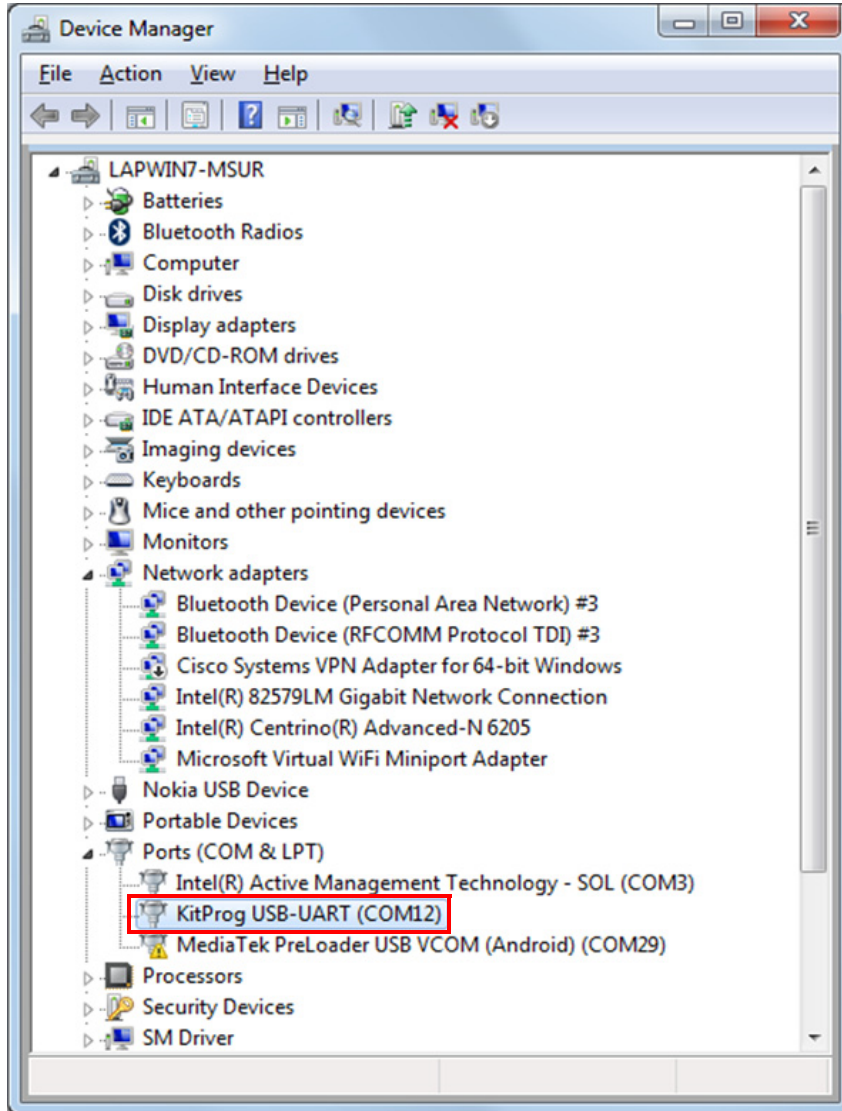

2. Open HyperTerminal, choose **File > New Connection**, enter a name for the new connection, and click **OK**, as shown in [Figure 6-31](#).

Figure 6-31. Open New Connection HyperTerminal

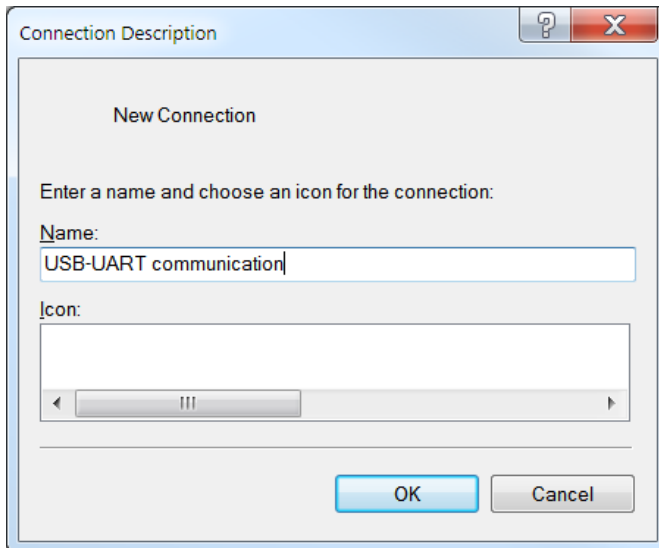

3. For PuTTY, double-click the PuTTY icon and select **Serial** under **Connection**, as shown in [Figure 6-32](#).

Figure 6-32. Open New Connection in PuTTY

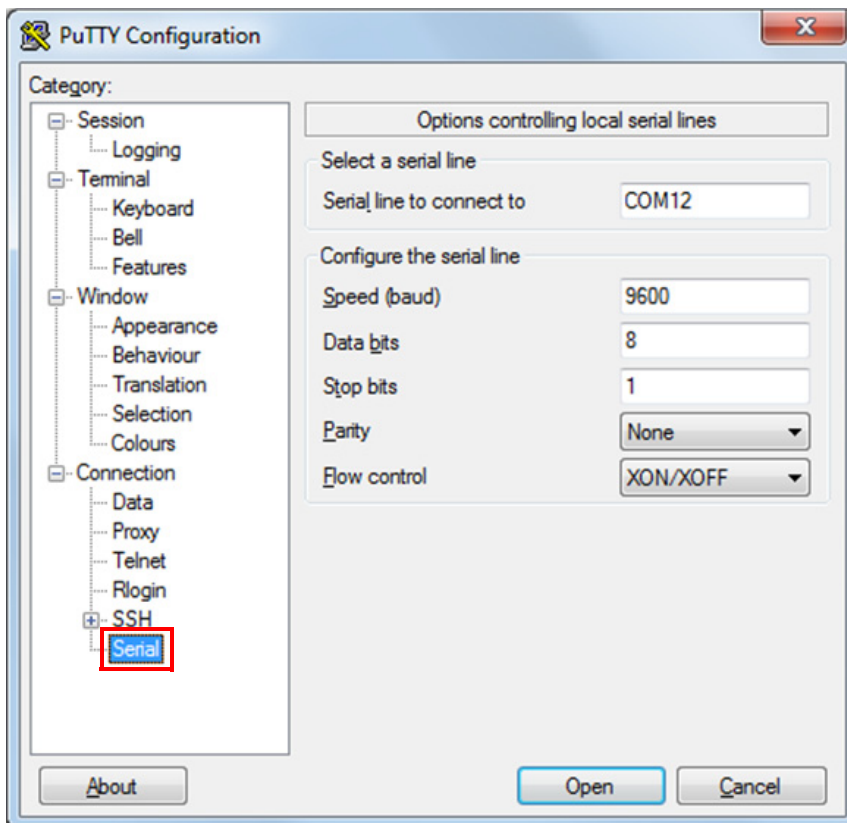

4. A new window opens, where you can select the communication port, as shown in [Figure 6-33](#).
 - a. In HyperTerminal, select COMx (or the specific communication port that is assigned to the Kit-Prog USB-UART) in **Connect using** and click **OK**. This code example uses **COM12**.
 - b. In PuTTY, enter COMx in **Serial line to connect to**. This code example uses **COM12**.

Figure 6-33. Select Communication Port - HyperTerminal and PuTTY

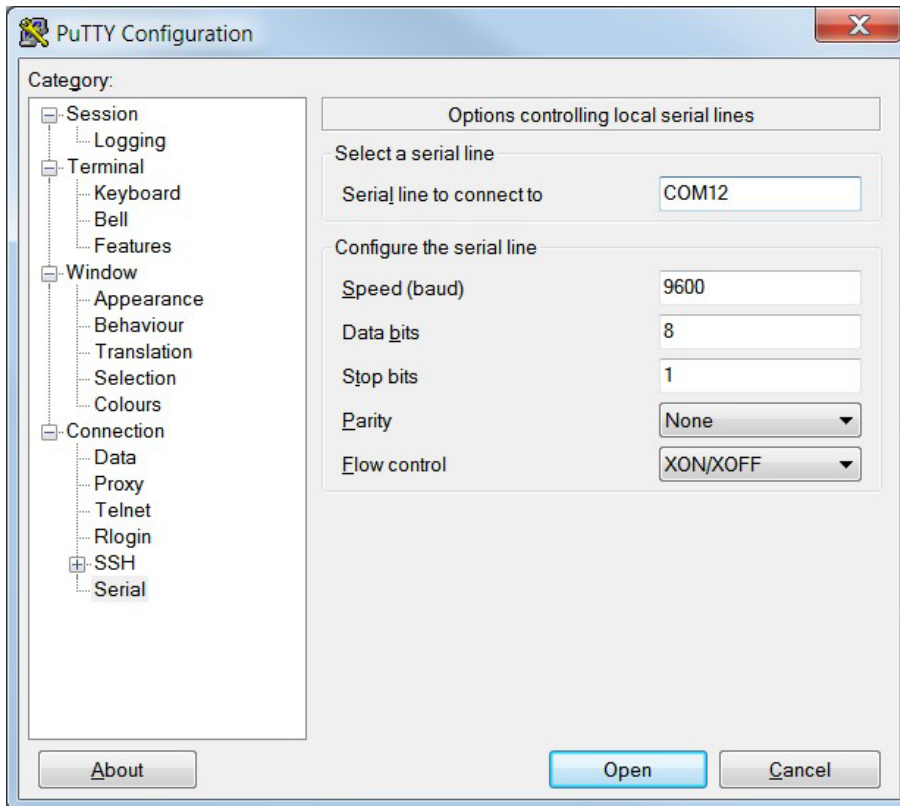
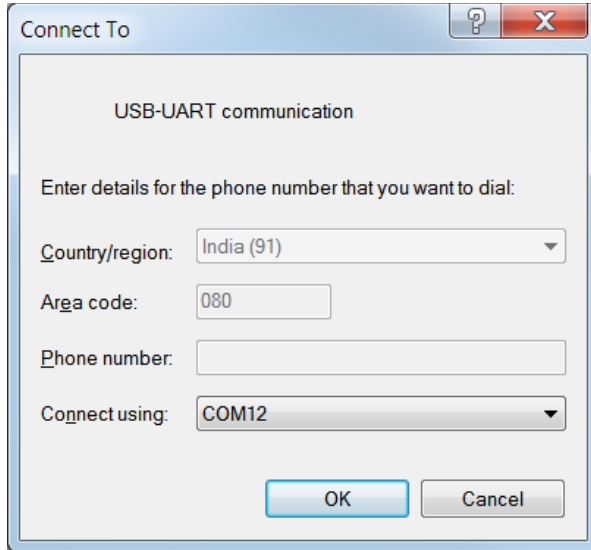

5. In HyperTerminal, select **Bits per second**, **Data bits**, **Parity**, **Stop bits**, and **Flow control** under **Port Settings** and click **OK**, as shown in [Figure 6-34](#). Make sure that the settings are identical to the UART settings configured for PSoC 4.

In PuTTY, select **Speed (baud)**, **Data bits**, **Stop bits**, **Parity**, and **Flow control** under **Configure the serial line** shown in [Figure 6-33](#) (second image). Click **Session** and select **Serial** under **Connection type**, as shown in [Figure 6-35](#). **Serial line** shows the communication port (COM12), and **Speed** shows the baud rate selected. Click **Open** to start the communication.

Figure 6-34. Configure Communication Port in HyperTerminal

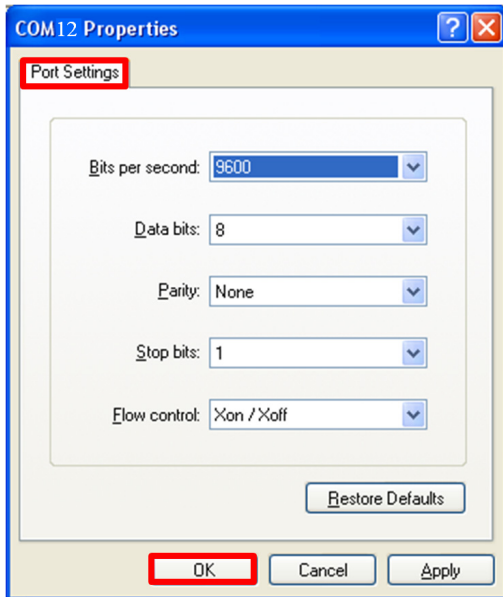
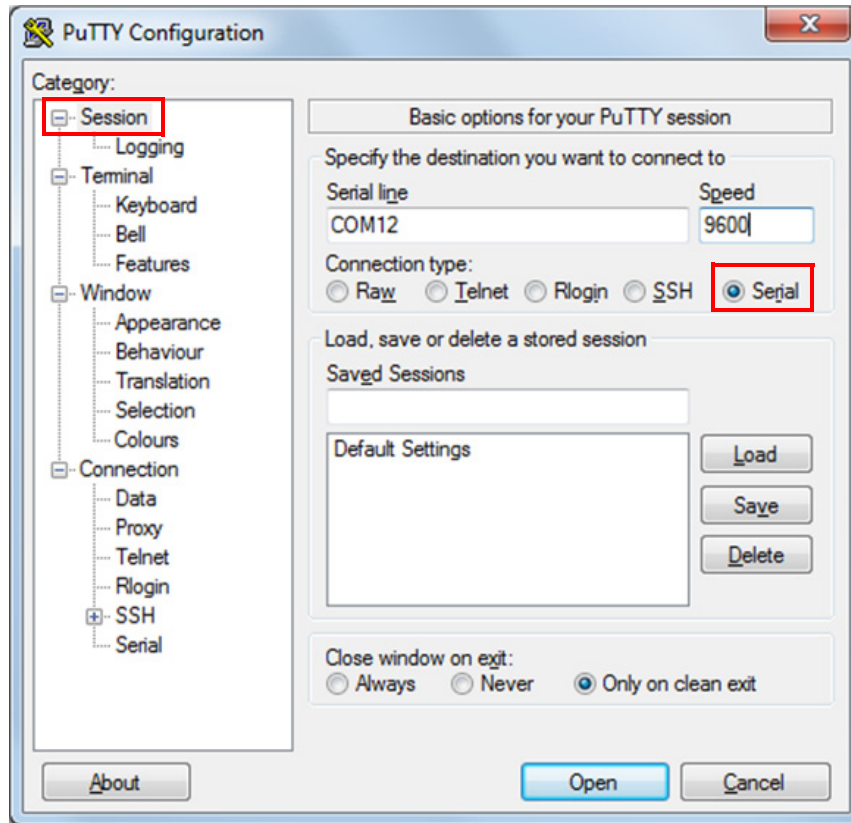

Figure 6-35. Select Communication Type in PuTTY



6. Enable **Echo typed characters locally** under **File > Properties > Settings > ASCII Setup** to display the typed characters in HyperTerminal, as shown in [Figure 6-36](#). In PuTTY, enable **Force on** under **Terminal > Line discipline options** to display the typed characters in PuTTY, as shown in [Figure 6-37](#).

Figure 6-36. Enable Echo of Typed Characters in HyperTerminal

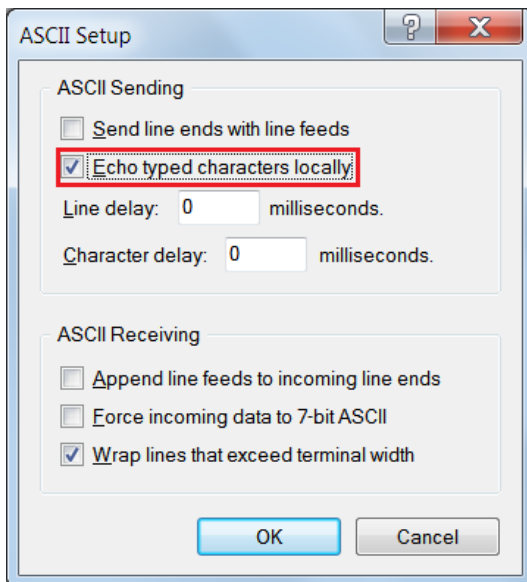
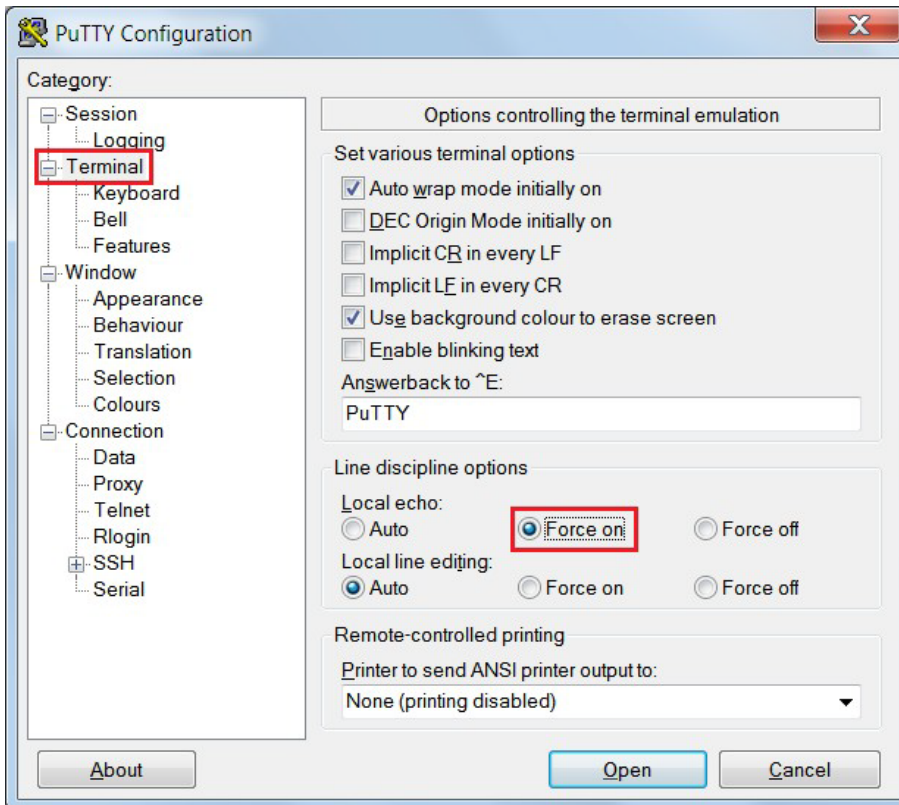

Figure 6-37. Enable Echo of Typed Characters in PuTTY



7. The COM terminal software displays both the typed data and the echoed data from the PSoC 4 UART, as shown in Figure 6-38 and Figure 6-39.

Figure 6-38. Data Displayed on HyperTerminal

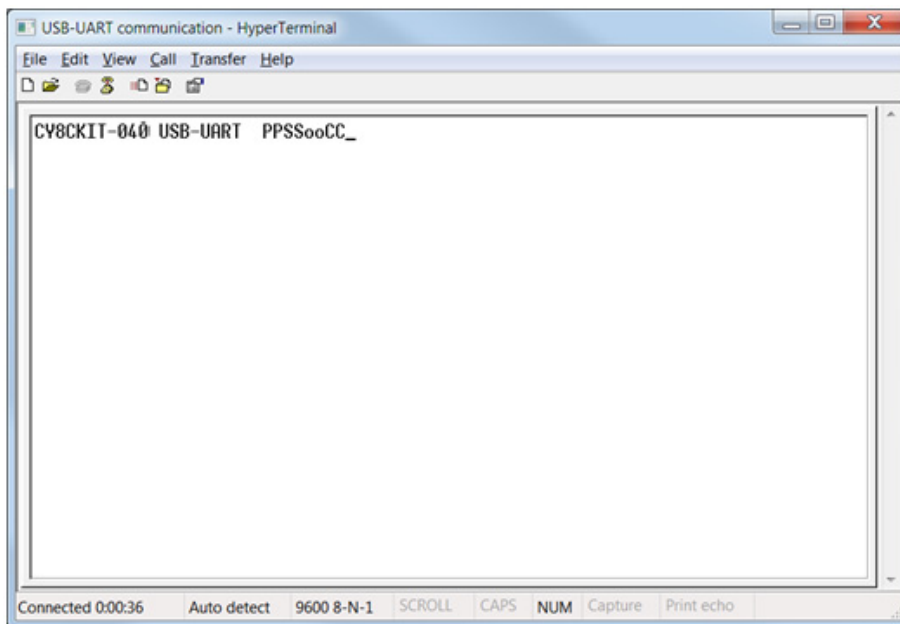
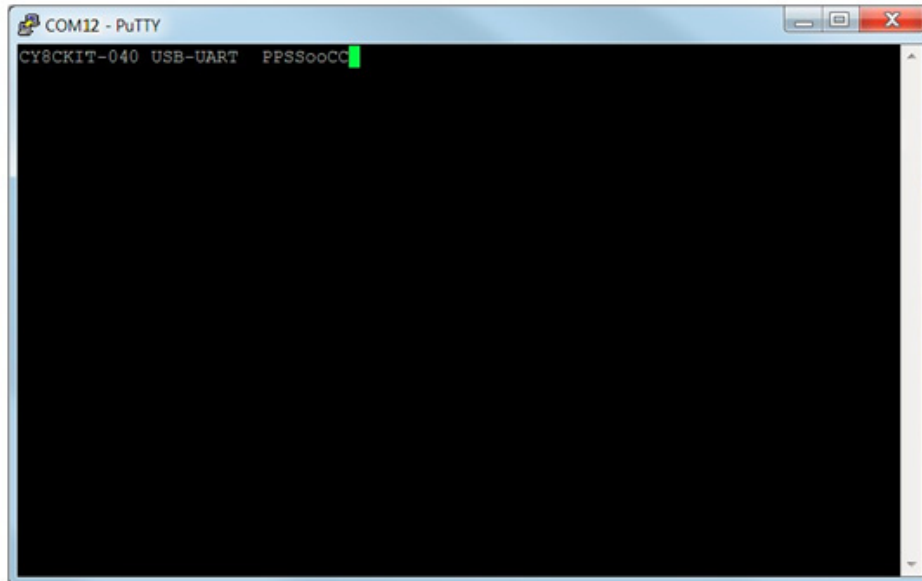

Figure 6-39. Data Displayed on PuTTY



6.4 Developing Applications for PSoC 5LP

The PSoC 4000 Pioneer Kit has an onboard PSoC 5LP whose primary function is that of a programmer and a bridge. You can build either a normal project or a bootloadable project using the PSoC 5LP.

The PSoC 5LP connections on the board are summarized in [Figure 6-40](#). J8 is the I/O connector (see [A.2.2 PSoC 5LP GPIO Header \(J8\)](#)). The USB (J10) is connected and used as the PC interface. However, you can still use this USB connection to create customized USB designs.

The programming header (J7) is meant for standalone programming. This header needs to be populated. See the "No Load Components" section in [A.6 Bill of Materials](#).

Figure 6-40. PSoC 5LP Block Diagram

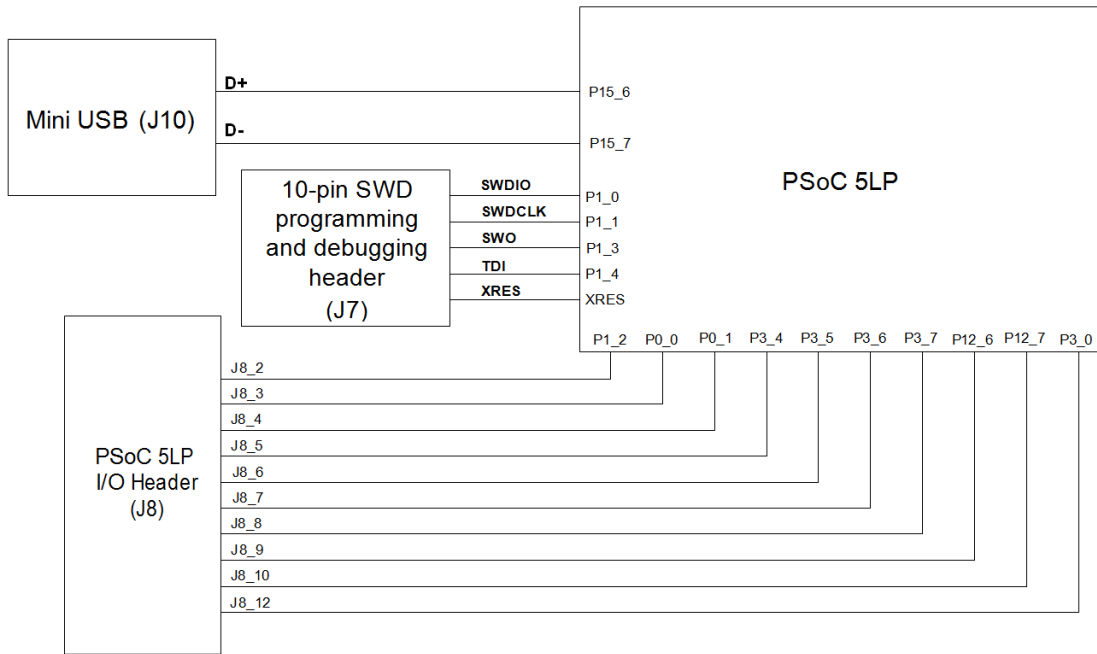

6.4.1 Building a Bootloadable Project for PSoC 5LP

All bootloadable applications developed for the PSoC 5LP should be based on the bootloader hex file, which is programmed onto the kit. The bootloader hex file is available in the kit files or can be downloaded from the kit web page.

The hex files are included in the following kit installer directory, as illustrated in Figure 6-41:

```
<Install_Directory>\CY8CKIT-040 PSoC 4000 Pioneer Kit\<version>\Firmware\Programmer\KitProg_Bootloader
```

Figure 6-41. KitProg Bootloader Hex File Location

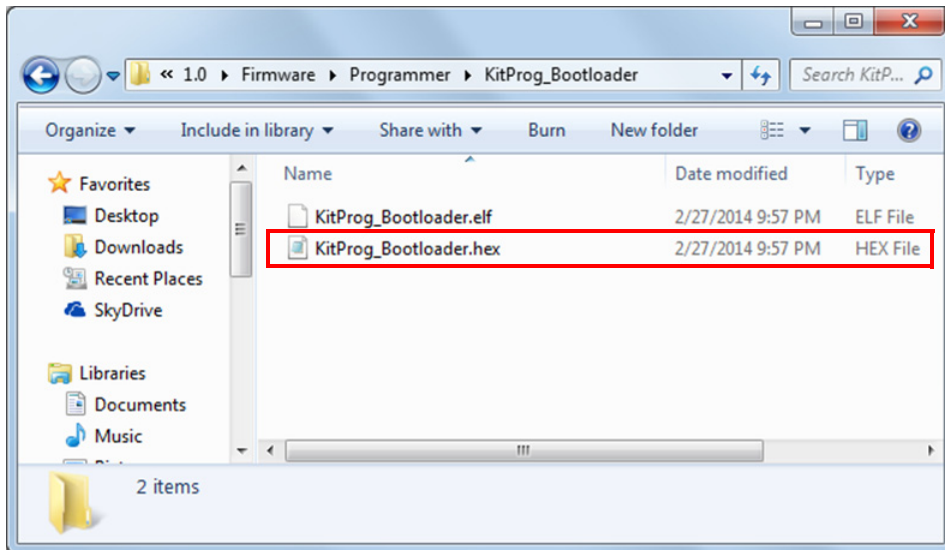

To build a bootloadable application for the PSoC 5LP, follow this procedure:

1. In PSoC Creator, choose **New > Project > PSoC 5LP**; click the expand button adjacent to Advanced and select the **Device** as **CY8C5868LTI-LP039**, as shown in [Figure 6-42](#). Select the **Application Type** as **Bootloadable** from the drop-down list.

Figure 6-42. Create a New Project in PSoC Creator

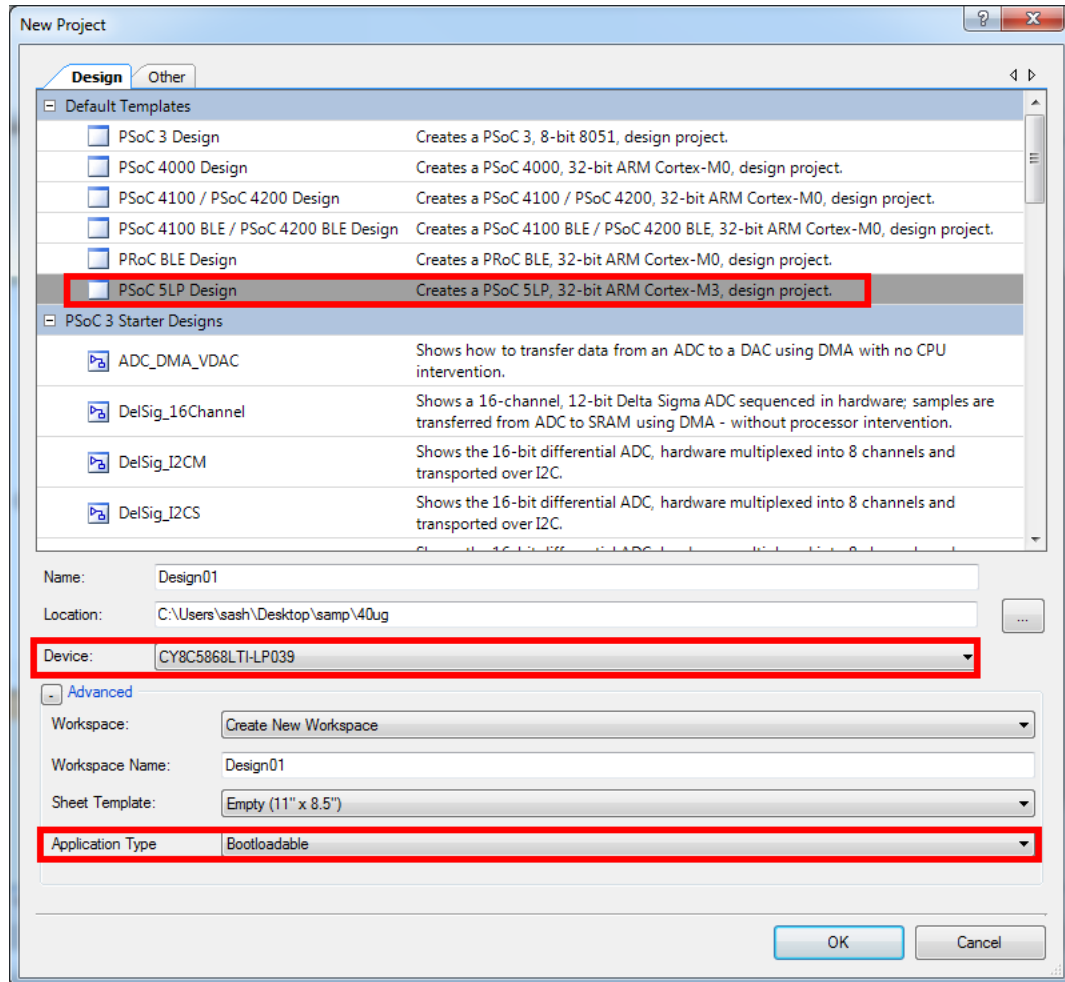

2. Navigate to the schematic view and drag and drop a **Bootloadable** Component on the TopDesign.

Figure 6-43. Bootloadable Component in Component Catalog

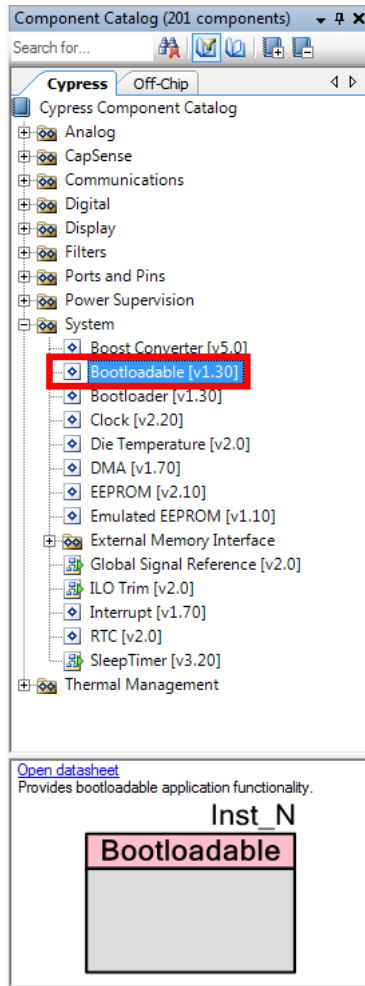

- Set the dependency of the Bootloadable Component by selecting the **Dependencies** tab in the configuration window and clicking the **Browse** button, as shown in [Figure 6-44](#). Select the *KitProg_Bootloader.hex* and *KitProg_Bootloader.elf* files; click **Open**, as shown in [Figure 6-45](#) and [Figure 6-46](#) and then click **OK** on the Configuration window.

Figure 6-44. Configuration Window of Bootloadable Component

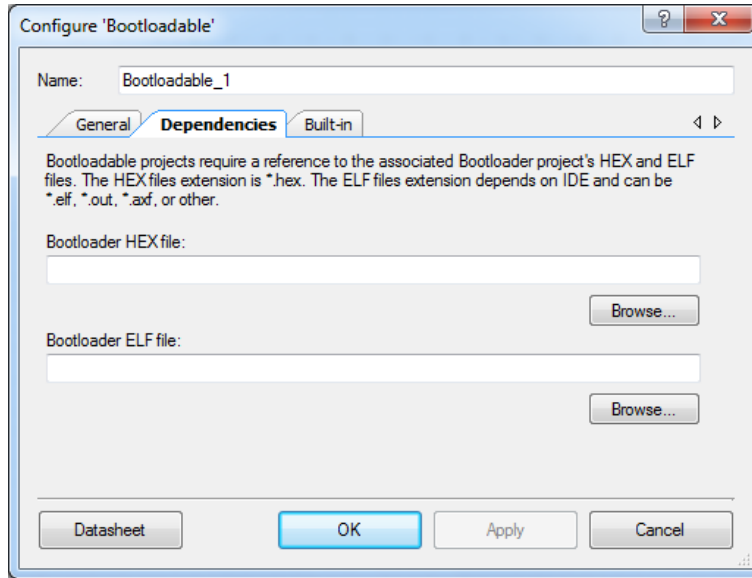

Figure 6-45. Select KitProg Bootloader Hex File

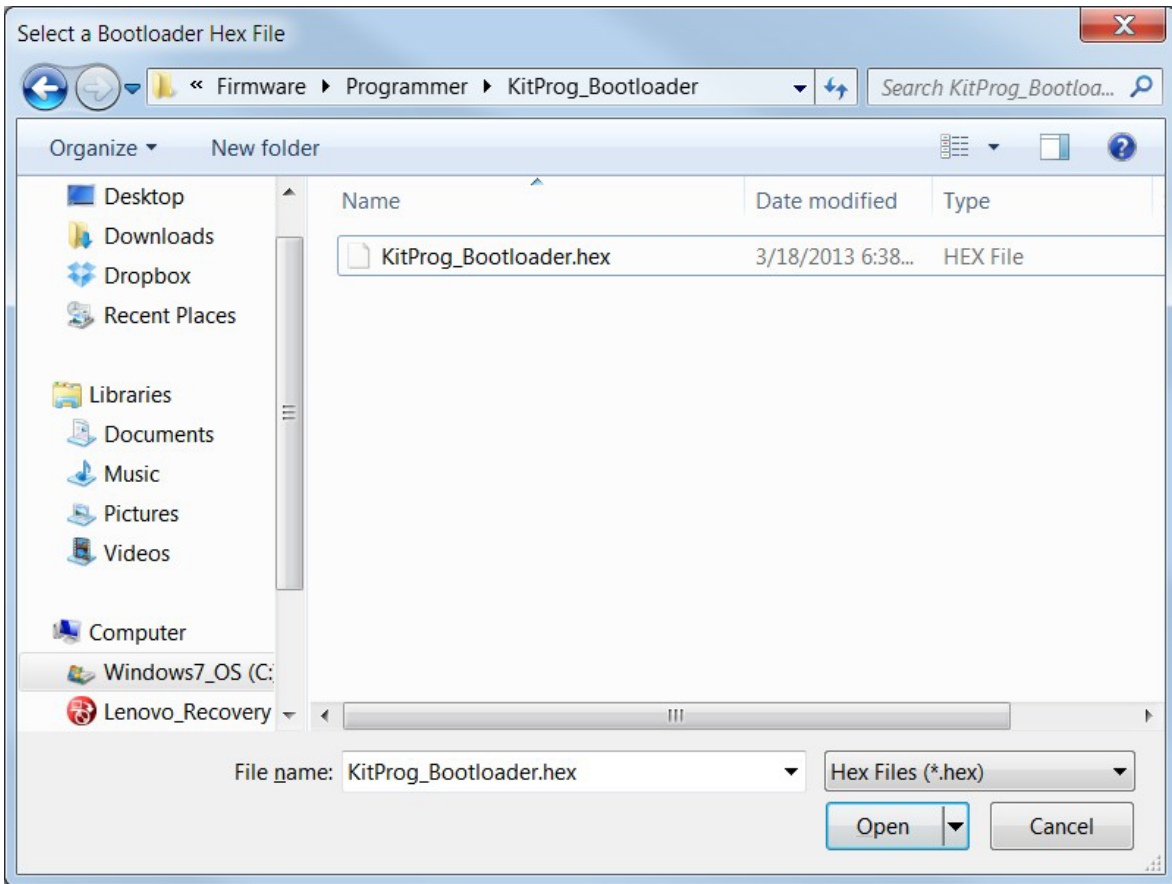
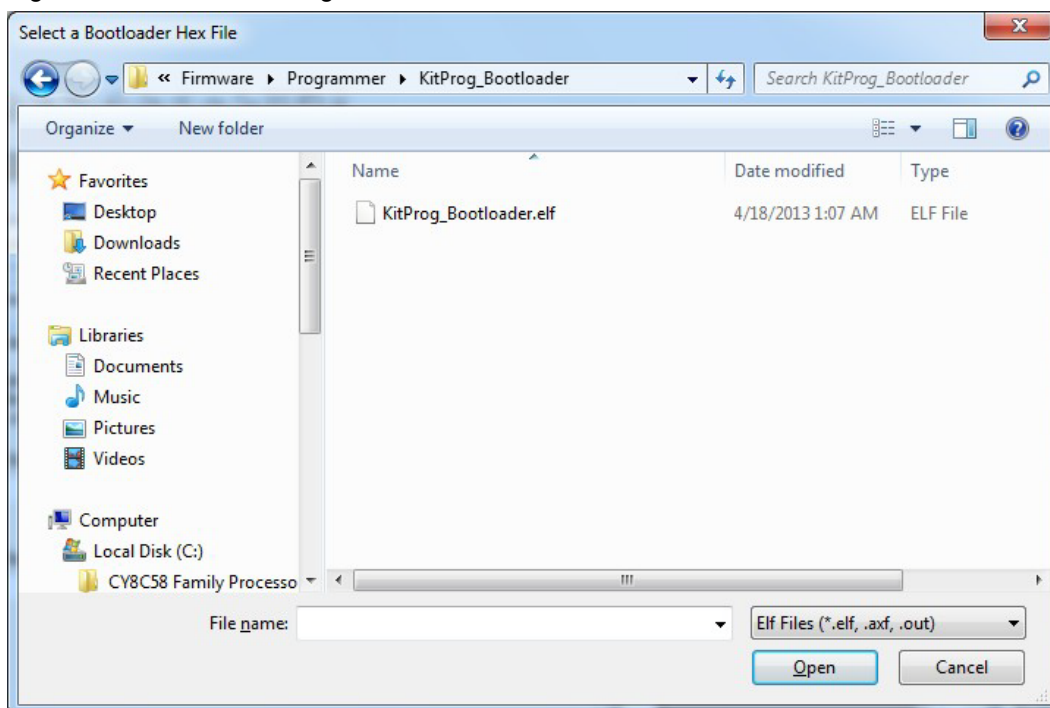
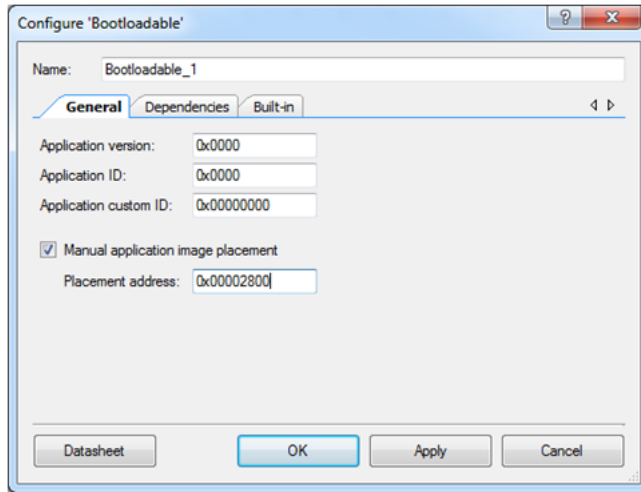

Figure 6-46. Select KitProg Bootloader Elf File



- In the **General** tab, check the **Manual application image placement** checkbox and set the placement address as “0x00002800” as shown in [Figure 6-47](#).

Figure 6-47. Bootloadable Component-General Tab



- Develop your custom project.
- The NVL setting of the Bootloadable project and the KitProg_Bootloader project must be the same. [Figure 6-48](#) shows the *KitProg_Bootloader.cydwr* system settings.

Figure 6-48. KitProg Bootloader System Settings

Option	Value
Configuration	
Device Configuration Mode	Compressed
Enable Error Correcting Code (ECC)	<input type="checkbox"/>
Store Configuration Data in ECC Memory	<input checked="" type="checkbox"/>
Instruction Cache Enabled	<input checked="" type="checkbox"/>
Enable Fast IMO During Startup	<input checked="" type="checkbox"/>
Unused Bonded IO	Allow but warn
Heap Size (bytes)	0x80
Stack Size (bytes)	0x0200
Include CMSIS Core Peripheral Library Files	<input checked="" type="checkbox"/>
Programming\Debugging	
Debug Select	GPIO
Enable Device Protection	<input type="checkbox"/>
Embedded Trace (ETM)	<input type="checkbox"/>
Use Optional XRES	<input type="checkbox"/>
Operating Conditions	
VDDA (V)	5.0
Variable VDDA	<input checked="" type="checkbox"/>
VDDD (V)	5.0
VDDIO0 (V)	5.0
VDDIO1 (V)	5.0
VDDIO2 (V)	5.0
VDDIO3 (V)	5.0
Temperature Range	-40C - 85/125C

- Build the project in PSoC Creator by choosing **Build > Build Project** or pressing **[Shift] [F6]**.
- Keep the reset switch (SW1) pressed and plug in the USB Mini-B connector. If the switch is pressed for more than 100 ms, the PSoC 5LP enters into bootloader.

9. To download the project onto the PSoC 5LP device, open the Bootloader Host tool, which is available from PSoC Creator. Choose **Tools > Bootloader Host**, as shown in [Figure 6-49](#).

Figure 6-49. Open Bootloader Host Tool from PSoC Creator

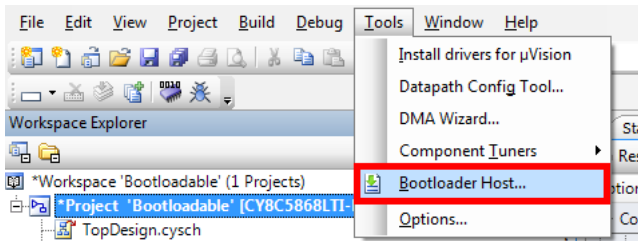

10. In the Bootloader Host tool, click **Filters** and add a filter to identify the USB device. Click **OK**, as shown in [Figure 6-50](#).

Figure 6-50. Port 'Filters' Tab in Bootloader Host Tool

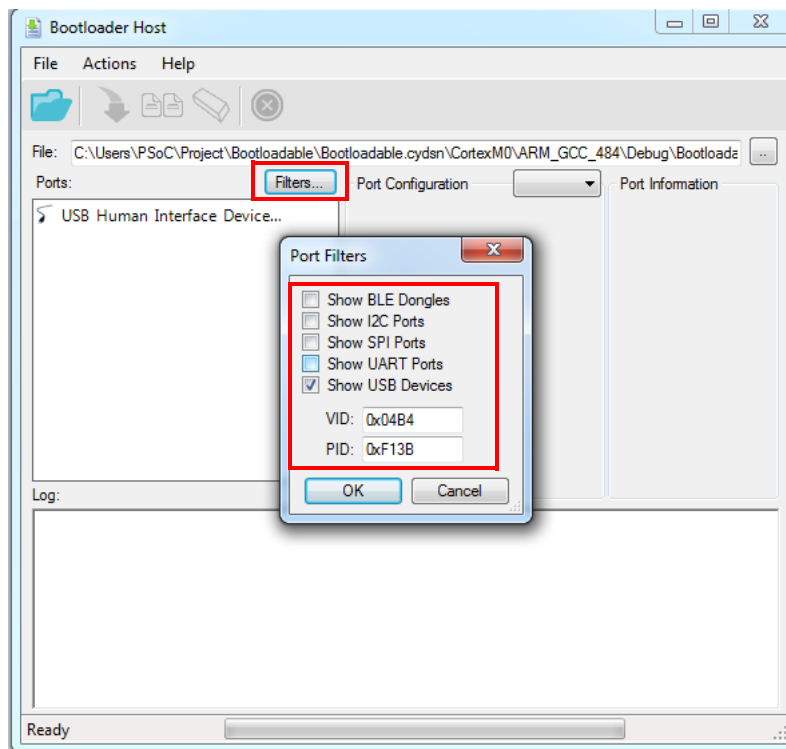

11. In the Bootloader Host tool, click the **Open File** button to browse to the location of the bootloadable file (*.cyacd), as shown in Figure 6-51.

Figure 6-51. Open Bootloadable File from Bootloader Host Tool

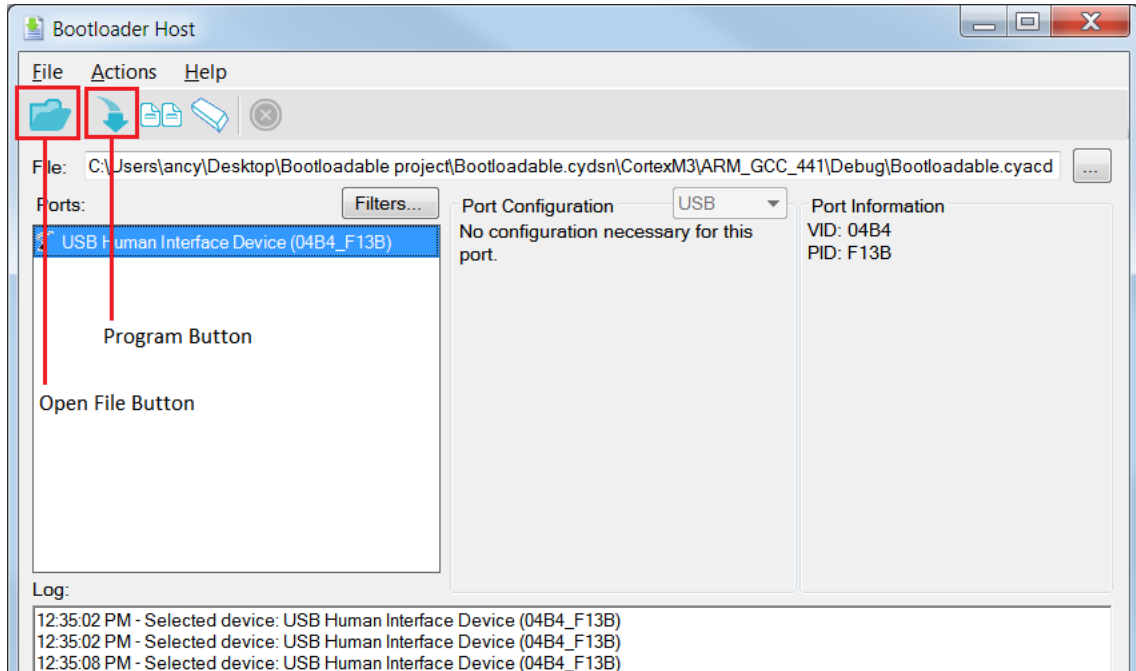
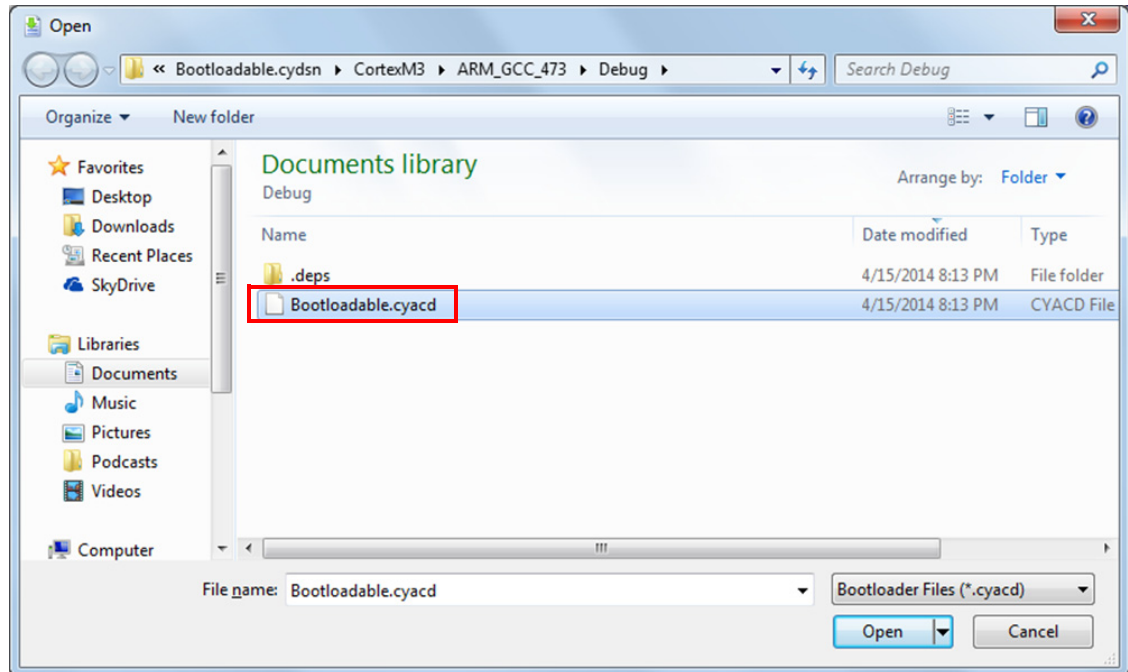

Figure 6-52. Select Bootloadable .cyacd File from Bootloader Host



12. Click the **Program** button in the Bootloader Host tool to program the device.

13. If bootload is successful, the log of the tool displays “Programming Finished Successfully”; otherwise, it displays “Failed” and a statement for the failure.

Notes:

- The PSoC 5LP pins are brought to the PSoC 5LP GPIO header (J8). These pins are selected to support high-performance analog and digital projects. See [A.2.2 PSoC 5LP GPIO Header \(J8\)](#) for pin information.
- Take care when allocating the PSoC 5LP pins for custom applications. For example, P2[0]-P2[4] are dedicated for programming the PSoC 4. Refer to [A.1 CY8CKIT-040 Schematics](#) before allocating the pins.
- When a custom bootloadable project is programmed onto the PSoC 5LP, the initial capability of the PSoC 5LP to act as a programmer, USB-UART bridge, or USB-I²C bridge is not available.
- The status LED does not function unless used by the custom project.

For additional information on bootloaders, refer to the Cypress application note [AN73503 – USB HID Bootloader for PSoC 3 and PSoC 5LP](#).

6.4.2 Building a Normal Project for PSoC 5LP

A normal project is a completely new project created for the PSoC 5LP device on the CY8CKIT-040. Here, the entire flash of the PSoC 5LP is programmed, overwriting all bootloader and programming code. To recover the programmer, reprogram the PSoC 5LP device with the factory-set *KitProg.hex* file, which is shipped with the kit installer.

The *KitProg.hex* file is available at the following location:

```
<Install_Directory>\CY8CKIT-040 PSoC 4000 Pioneer Kit\<version>\Firmware\Programmer\KitProg
```

This advanced functionality requires a MiniProg3 programmer, which is not included with this kit. The MiniProg3 can be purchased from www.cypress.com/go/CY8CKIT-002. To build a normal project for the PSoC 5LP, follow these steps:

1. In PSoC Creator, choose **New > Project > PSoC 5LP**; click the expand button adjacent to Advanced and select **Device** as **CY8C5868LTI-LP039**; select **Application Type** as **Normal** from the drop-down list, as shown in [Figure 6-53](#).

Figure 6-53. Create a New Project in PSoC Creator

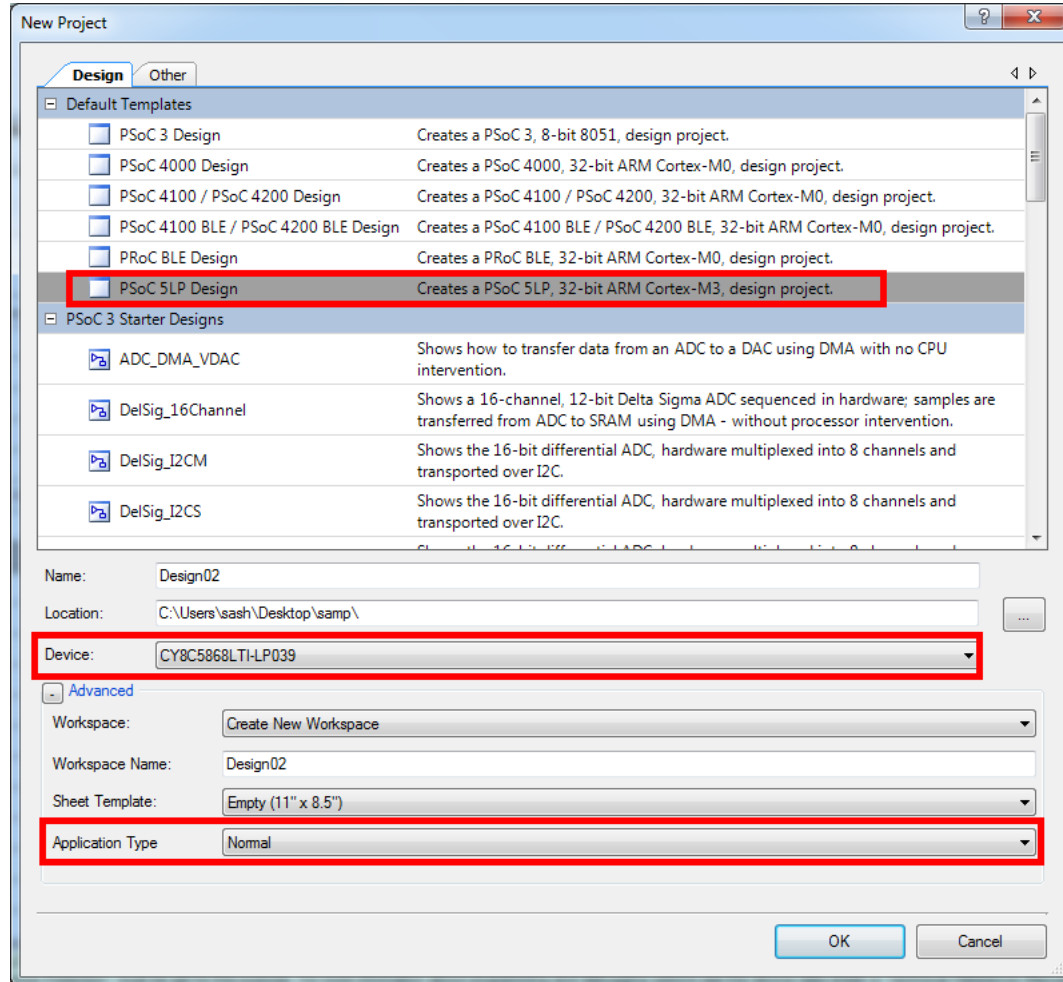

2. Develop your custom project.
3. Build the project in PSoC Creator by choosing **Build > Build Project** or pressing **[Shift] [F6]**.
4. Connect the 10-pin connector of MiniProg3 to the onboard 10-pin SWD debug and programming header J7 (which needs to be populated).
5. To program the PSoC 5LP with PSoC Creator, choose **Debug > Program** or press **[Ctrl] [F5]**. The Programming window shows MiniProg3 and the selected device in the project under it (CY8C5868LTI-LP039).
6. Click on the device and click **Connect** to program.

Notes:

- The 10-pin SWD debug and programming header (J7) is not populated. See the "No Load Components" section of [Bill of Materials on page 171](#) for details.
- The PSoC 5LP pins are brought to the PSoC 5LP GPIO header (J8). These pins are selected to support high-performance analog and digital projects. See [PSoC 5LP GPIO Header \(J8\) on page 168](#) for pin information.

- Take care when allocating the PSoC 5LP pins for custom applications. For example, P2[0]-P2[4] are dedicated for programming the PSoC 4. Refer to [CY8CKIT-040 Schematics on page 161](#) before allocating the pins.
- When a normal project is programmed onto the PSoC 5LP, the initial capability of the PSoC 5LP to act as a programmer, USB-UART bridge, or USB-I²C bridge is not available.
- The status LED does not function unless used by the custom project.

6.5 PSoC 5LP Factory Program Restore Instructions

The CY8CKIT-040 PSoC 4000 Pioneer Kit features a PSoC 5LP device that comes factory-programmed as the onboard programmer and debugger for the PSoC 4 device.

In addition to creating applications for the PSoC 4 device, you can also create custom applications for the PSoC 5LP device on this kit as explained in [Developing Applications for PSoC 5LP on page 133](#). Reprogramming or bootloading the PSoC 5LP device with a new flash image will overwrite the factory program and forfeit the ability to use the PSoC 5LP device as a programmer/debugger for the PSoC 4 device. Follow these instructions to restore the factory program on the PSoC 5LP and enable the programmer/debugger functionality.

6.5.1 PSoC 5LP Programmed with a Bootloadable Application

If the PSoC 5LP is programmed with a bootloadable application, restore the factory program by using one of the following two methods.

6.5.1.1 *Restore PSoC 5LP Factory Program Using PSoC Programmer*

1. Launch PSoC Programmer 3.18 or later from **Start > Cypress > PSoC Programmer**.
2. Configure the kit in Service mode. To do this, while holding down the reset button (SW1 Reset), plug the PSoC 4000 Pioneer Kit into the computer using the included USB cable (USB A to Mini-B). This puts the PSoC 5LP into service mode, which is indicated by the blinking green status LED.

- The following message shown in [Figure 6-54](#) appears in the PSoC Programmer results window:
"KitProg Bootloader device is detected."

Figure 6-54. PSoC Programmer Results Window

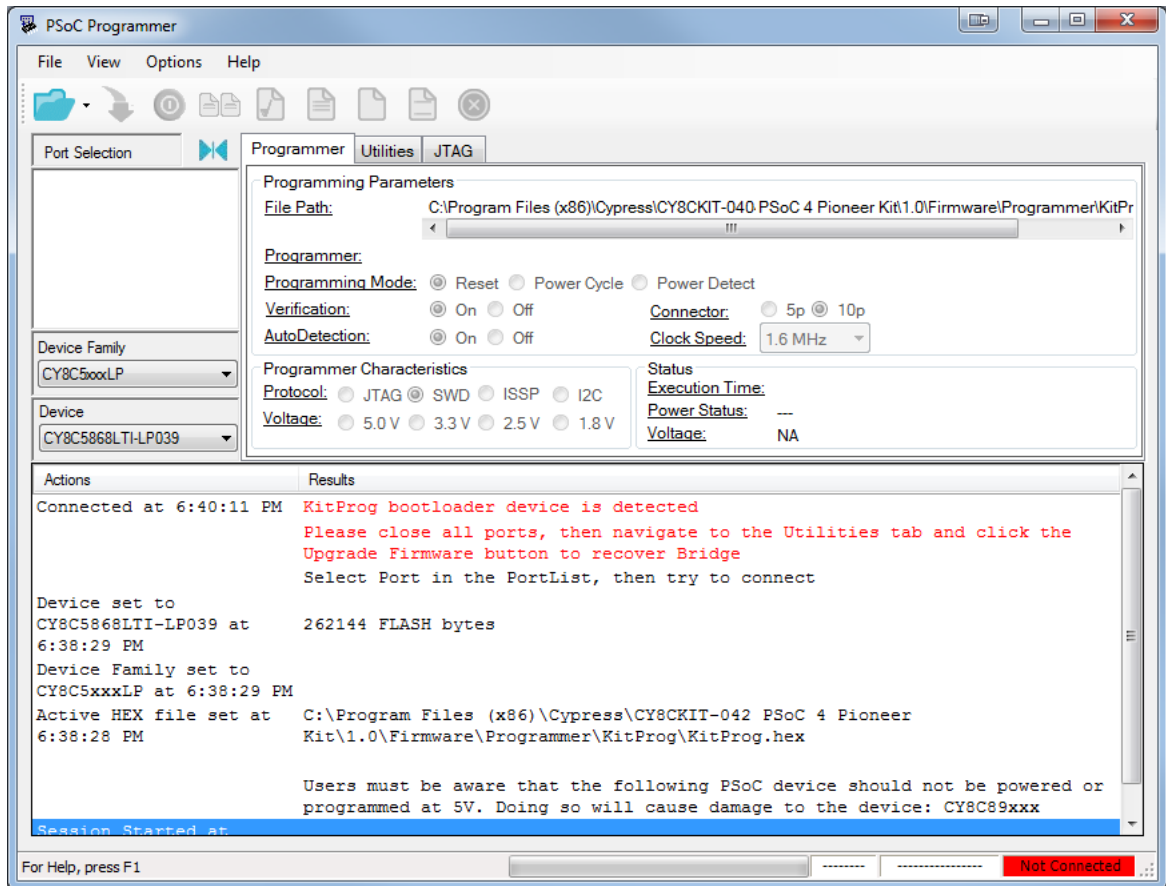

4. Switch to the **Utilities** tab in PSoC Programmer and click the **Upgrade Firmware** button, as shown in [Figure 6-55](#). Unplug all other PSoC programmers (such as MiniProg3 and DVKProg) from the PC before clicking the **Upgrade Firmware** button.

Figure 6-55. Upgrade Firmware

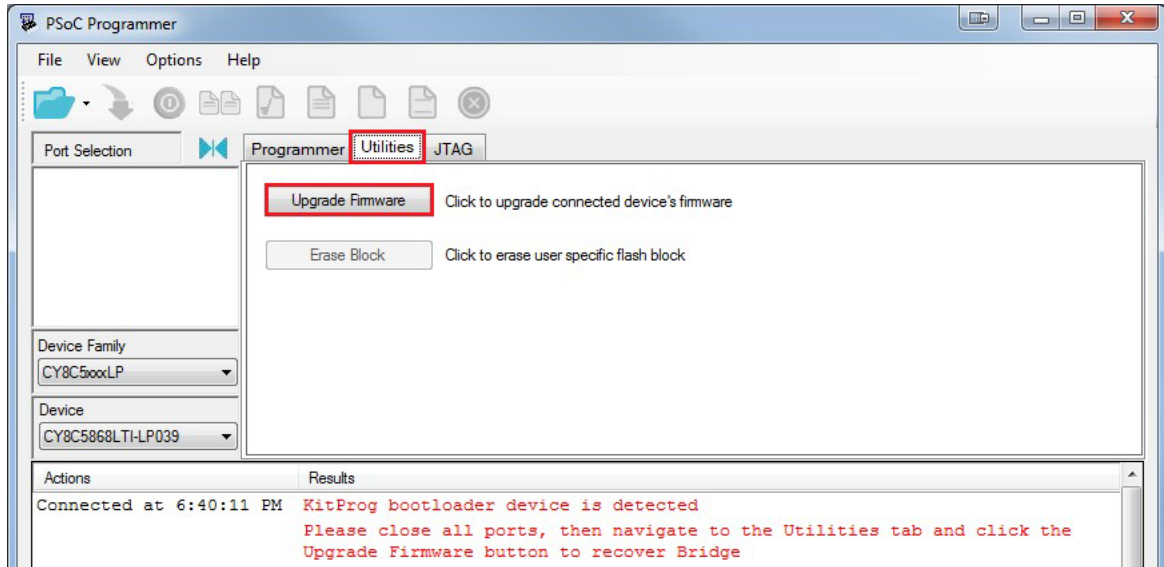

- After programming is completed, the following message appears: "Firmware Update Finished at <time>," as shown in Figure 6-56.

Figure 6-56. Firmware Update Complete

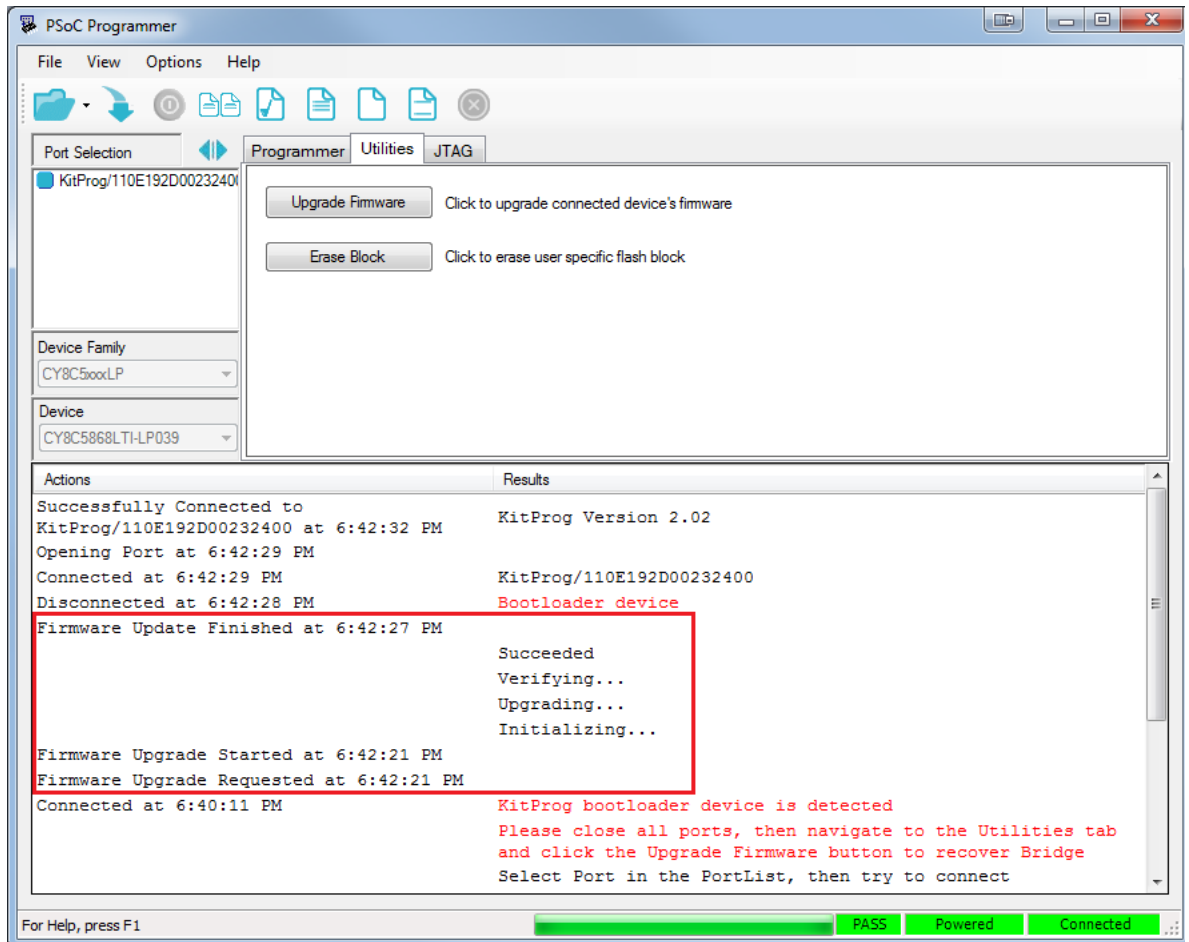

- The factory program is now successfully restored on the PSoC 5LP. It can be used as the programmer/debugger for the PSoC 4 device.

6.5.1.2 Restore PSoC 5LP Factory Program Using USB Host Tool

1. Launch the Bootloader Host tool from **Start > Cypress > PSoC Creator**.

Using the **File > Open** menu, load the *Kit Prog.cyacd* file, which is installed with the kit software.

The default location for this file is <Install_Directory>\CY8CKIT-040 PSoC 4000 Pioneer Kit\<version>\Firmware\Programmer\KitProg\KitProg.cyacd.

Figure 6-57. Load KitProg.cyacd File

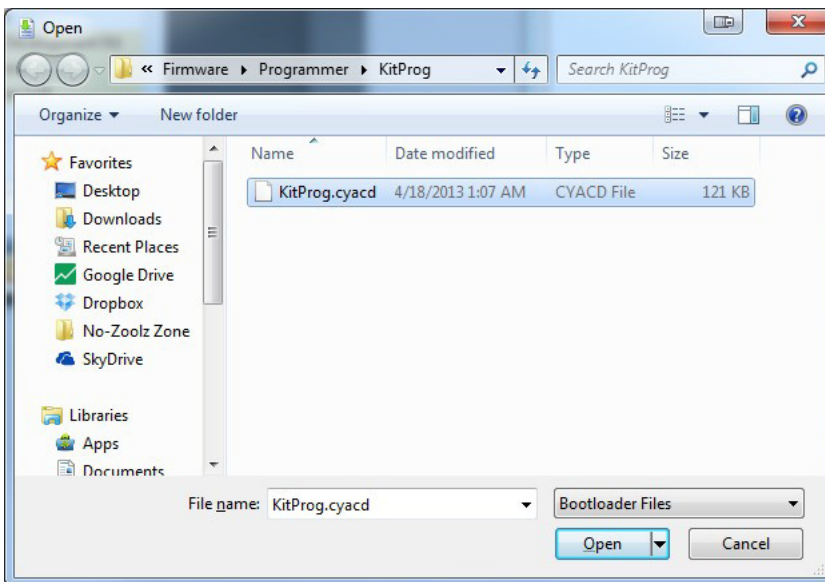
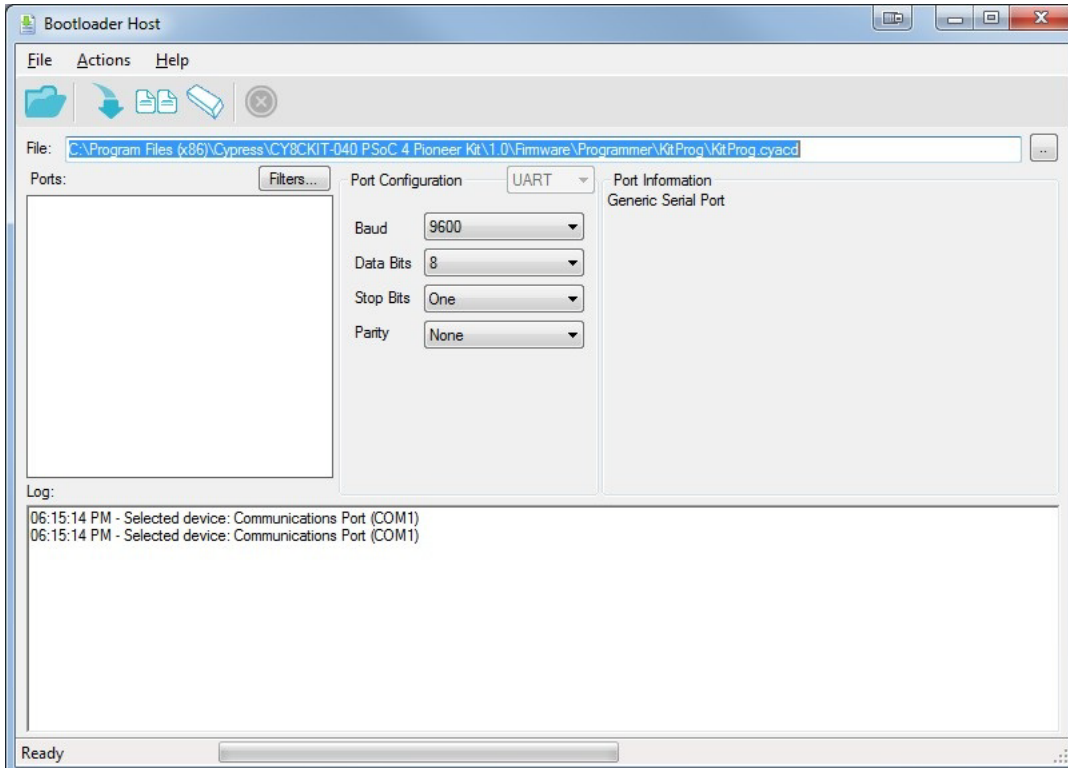

2. Configure the Pioneer Kit in Service mode. To do so, while holding down the reset button (SW1 Reset), plug the PSoC 4000 Pioneer Kit into the computer using the included USB cable (USB A to Mini-B). This puts the PSoC 5LP into service mode, which is indicated by the blinking green status LED.
3. In the Bootloader Host tool, set the filters for the USB devices with VID: 04B4 and PID: F13B. The **USB Human Interface Device** port appears in the Ports list. Click that port to select it.

Figure 6-58. Select USB Human Interface Device

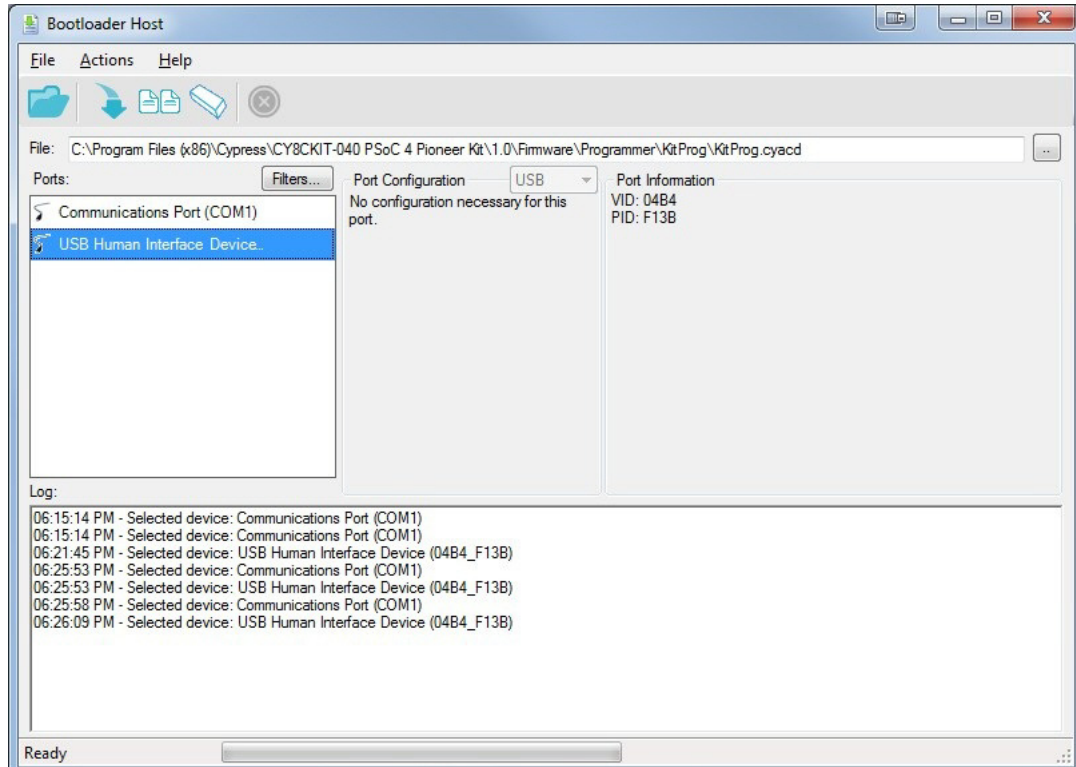

4. Click the **Program** button (or menu item **Actions > Program**) to restore the factory program by bootloading it onto the PSoC 5LP.

- After programming is completed, the following message appears "Programming Finished Successfully," as shown in [Figure 6-59](#).

Figure 6-59. Programming Finished Successfully

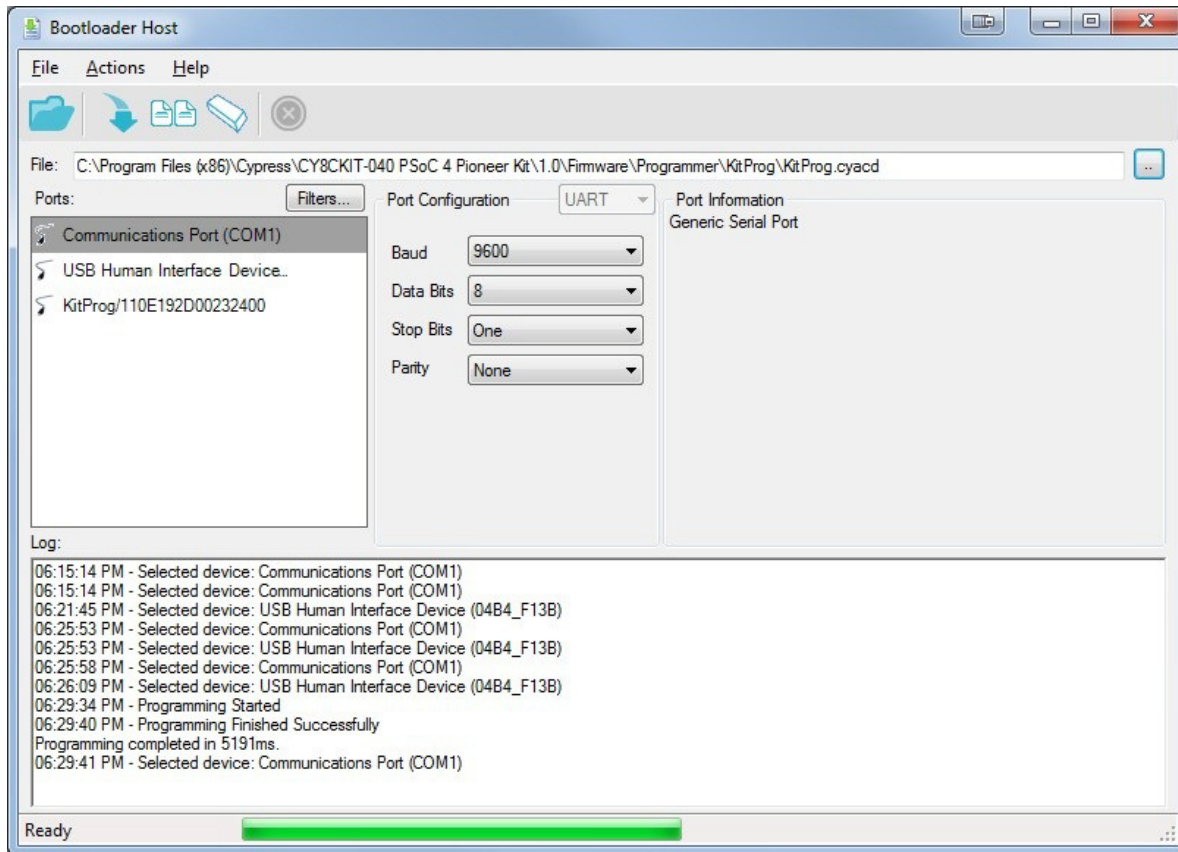

- The factory program is now successfully restored on the PSoC 5LP. You can now use it as the programmer/debugger for the PSoC 4 device.

6.5.2 PSoC 5LP Programmed with a Standard Application

If PSoC 5LP is programmed with a standard application, restore the factory program by using the following method.

- Launch PSoC Programmer 3.18 or later from **Start > Cypress > PSoC Programmer**.
- Use the **File > Open** menu to load the *KitProg.hex* factory program hex file, which is shipped with the kit. The default location for this file is <Install_Directory>\CY8CKIT-040 PSoC 4000 Pioneer Kit\<version>\Firmware\Programmer\KitProg.
- Connect a CY8CKIT-002 MiniProg3 (sold separately) to the computer. The 10-pin connector cable on the MiniProg3 plugs into the header [J7]. Note that the J7 header is unpopulated. For more details, see [Bill of Materials on page 171](#).

4. Ensure that MiniProg3 is the selected port in PSoC Programmer and the 10-pin connector (10p option) is selected, as shown in [Figure 6-60](#). If the board is not powered over USB, select the **Power Cycle** programming mode.

Figure 6-60. Select MiniProg3

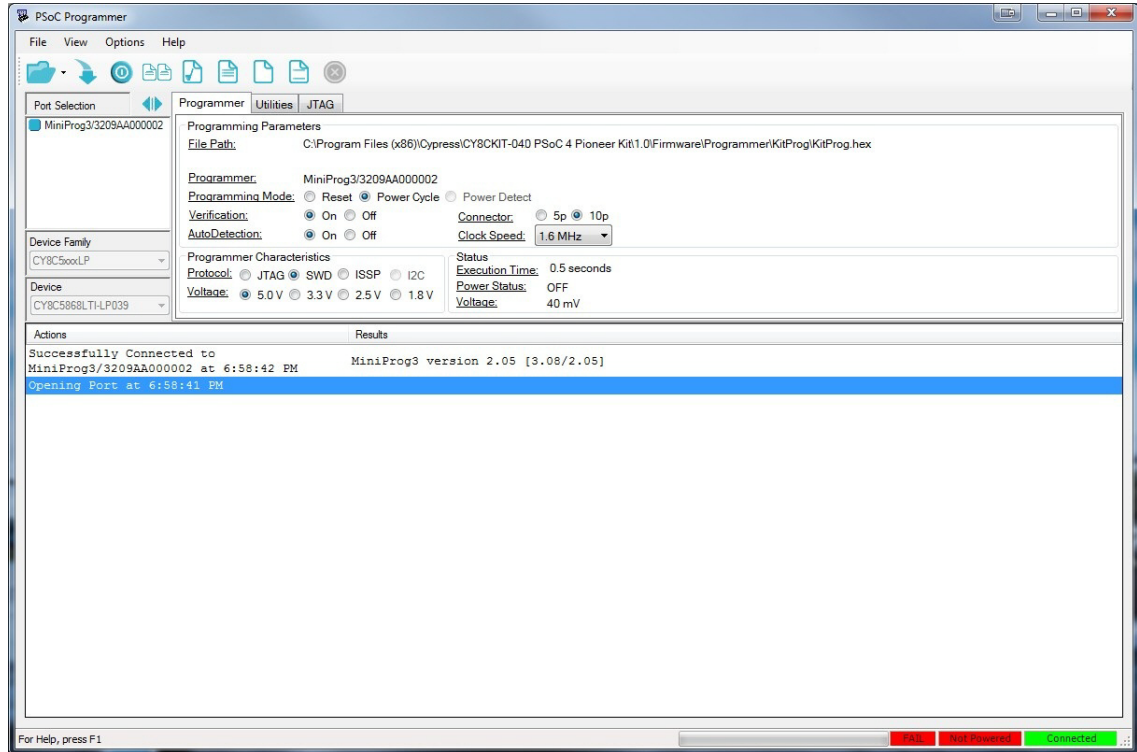

- When ready, select the **Program** button (or **File > Program**) to program the PSoC 5LP device, as shown in [Figure 6-61](#).
- After programming is completed, the following message appears: "Program Finished at <time>."

Figure 6-61. Program Finished

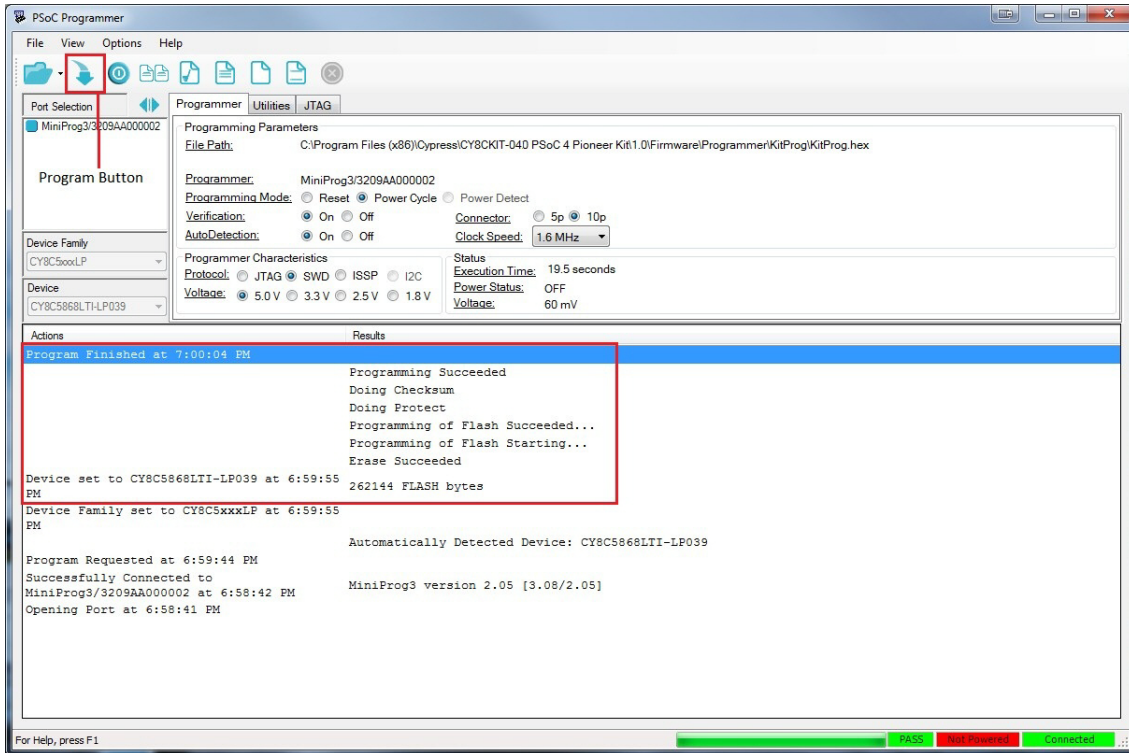

- The factory program is now successfully restored on the PSoC 5LP. You can use it as the programmer/debugger for the PSoC 4 device.

6.6 Using μ C/Probe Tool

Micrium's μ C/Probe is a windows application that allows you to read and write the memory of any embedded target processor during run-time, and map those values to a set of virtual controls and indicators placed on a graphical dashboard.

This tool helps in designing a simple GUI for the example projects of the development kits with least effort.

Please note that Micrium μ C/Probe tool is not a pre-requisite software required to run this kit and does not get installed along with kit contents.

The license required to use all the features of the tool need to be purchased separately by the user. However, the educational edition of the tool is available as a free download from <http://micrium.com/download/ucprobe-3-0-trial-version/>.

The Educational Edition of μ C/Probe is available for free to enable you to "try before you buy". For more details on licensing and the μ C/Probe tool, please refer to the μ C/Probe Users' Manual at <http://micrium.com/download/%c2%b5cprobe-3-0-users-manual/>.

In Micrium μ C/Probe version 3.3, the Cypress KitProg is being supported as a means of communication to the target device connected to the PC.

When an example project is built in PSoC Creator, it produces the output files in HEX, LST, MAP, RPT and ELF formats.

The ELF file lists all the symbols (variables), symbol types and its addresses. The Micrium μ C/Probe tool reads the ELF file and detects these symbols (global variables) used in the code.

The μ C/Probe tool provides a host of graphical controls such as sliders, RGB palette, graphs, donuts etc. The controls required can be dragged and dropped onto μ C/Probe workbench, and symbols from the ELF file can be assigned to the controls.

When the workbench is run, the changes in symbol values associated with the controls (slider, graph etc) can be visualized on the PC.

Appropriate global variables have been assigned in CY8CKIT_040_Color_Palette and CY8CKIT_040_Proximity_UART example projects of the kit to visualize the color palette output and proximity output on a GUI.

CY8CKIT_040_Color_Palette Example Project:

To visualize the output of CY8CKIT_040_Color_Palette project using μ C/Probe tool, follow the steps given below:

1. Open the CY8CKIT-040_Color_Palette example project in PSoC Creator.
2. Program the CY8CKIT_040_Color_Palette example project on CY8CKIT-040 by following steps 1–8 in [Programming the Example Projects on page 51](#).

Note: Ensure that **Debug Select** in System settings of cydwr file is set to **SWD** before programming the board. Refer [Figure 5-8 on page 55](#). By default, CY8CKIT_040_Color_Palette example project has the **Debug Select** set to **SWD**. It needs to be changed to GPIO if TX port needs to be enabled in the project.

3. Download and install μ C/Probe tool from <http://micrium.com/download/ucprobe-3-0-trial-version/>
4. Launch μ C/Probe from **Start > All Programs > Micrium > uC-Probe > Micrium uC-Probe**

Figure 6-62. Micrium μ C/Probe

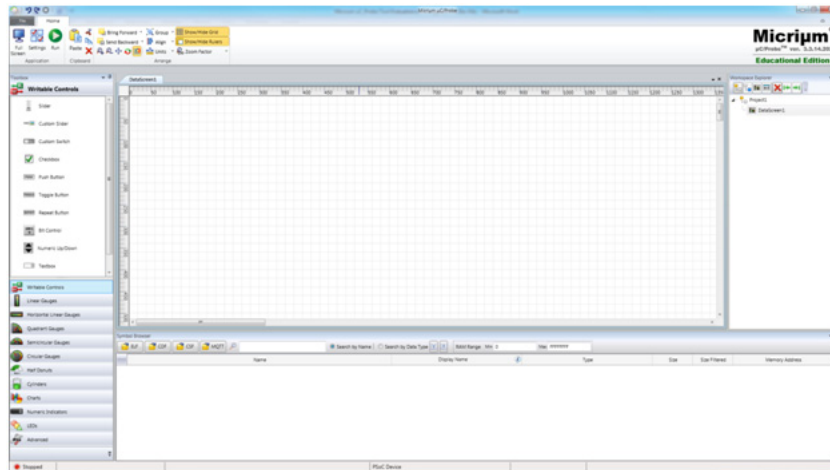

5. Drag and drop a RGB Palette control from Writable Controls in Toolbox on to the Datascreen to visualize the RGB output.

Figure 6-63. Adding RGB Palette Control

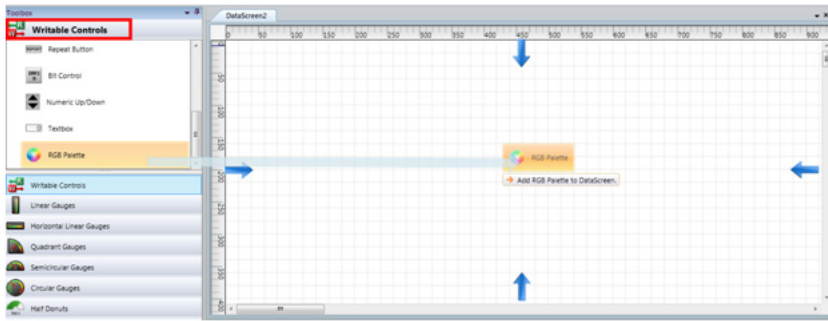

6. Next, add a Line Chart from Charts Controls in Toolbox on to the Datascreen to visualize the X, Y position of finger on trackpad.

Figure 6-64. Adding Line Chart Control

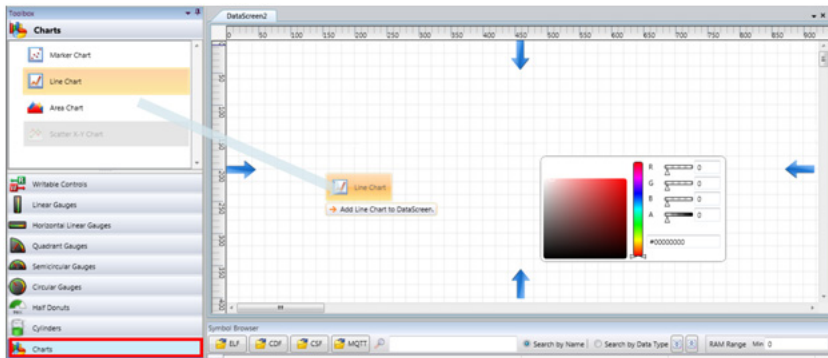

7. The DataScreen looks as below after adding both the controls.

Figure 6-65. DataScreen with RGB Palette and Line chart controls

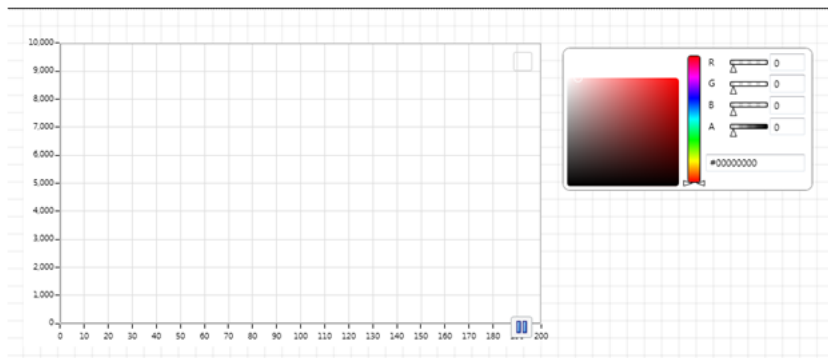

8. Now, click on the ELF button in the Symbol Browser window.

Figure 6-66. ELF button in Symbol Browser

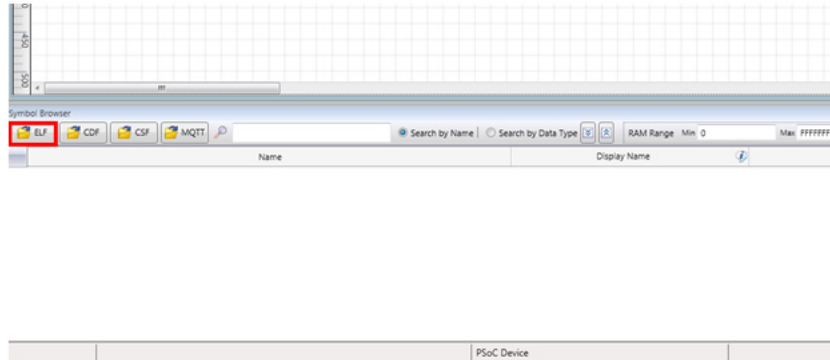

9. Browse and point to the CY8CKIT_040_Color_Palette.ELF file to load the symbols (global variables) from the Capsense example project. Wait until the ELF file gets loaded. The elf file is in the collapsed state by default. It can be expanded by clicking on the '+' button next to the file name.
10. On expanding the elf file, it can be seen that the Symbol Browser displays all the .C files in the example project. By expanding each file, the global variables defined in that C file are displayed with its name, type, size, memory address etc.
11. Now, expand the main.c file to view the global variables defined in main.c file.

Figure 6-67. Global variables in Symbol Browser

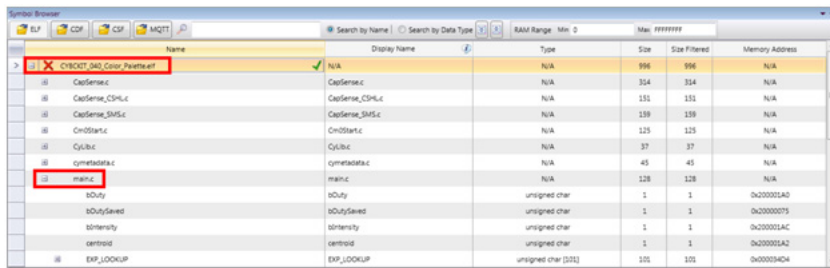

12. Drag and drop the global variable μ ARGB on to the RGB Palette to see the RGB output. Similarly, drag and drop xPos and yPos on to the Line chart control to see the X and Y position of the finger on trackpad.

Figure 6-68. Assigning RGB output to RGB Palette control

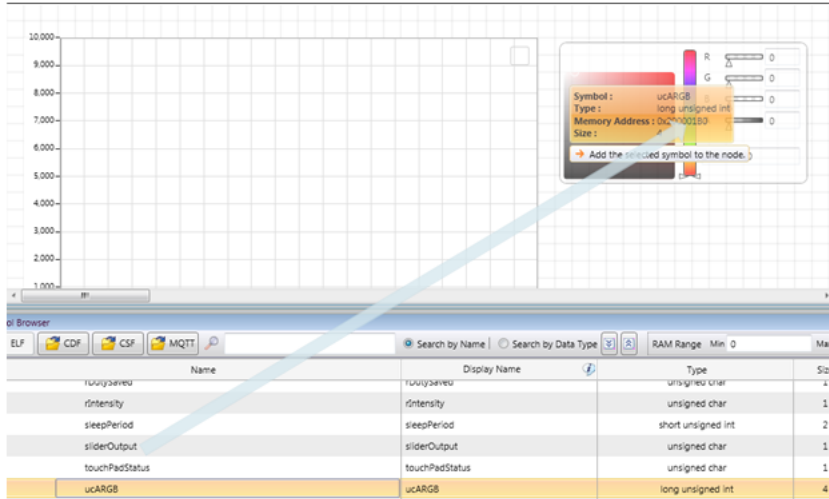

Figure 6-69. Assigning x Position output to Line Chart control

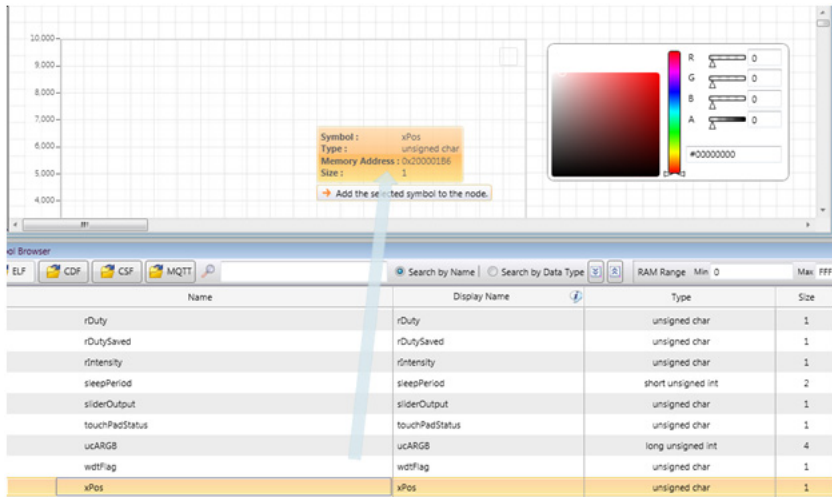
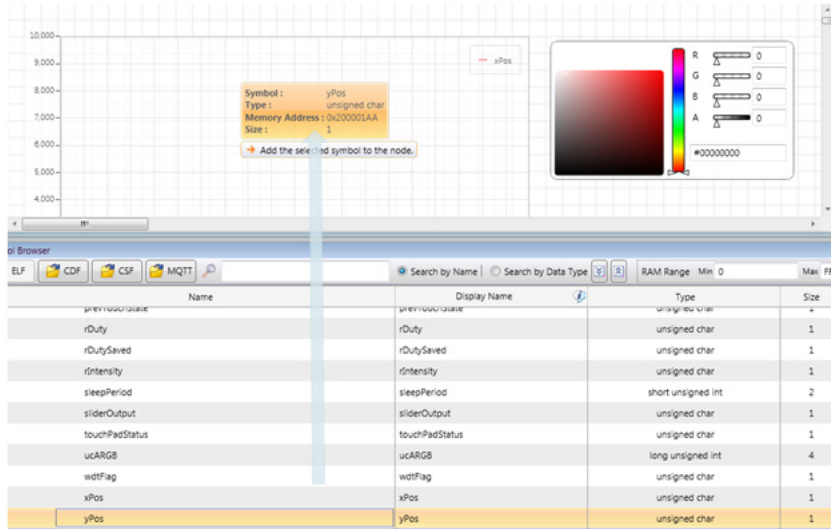

Figure 6-70. Assigning y Position output to Line Chart control



13. By default, the y axis of Line chart control is plotted for values between 0–10000. To change the y axis scale to 0–100, click on the Line chart control to get the Line chart control toolbar. Click on the Properties Editor icon in the toolbar. Refer figure below.

Figure 6-71. Line chart control toolbar

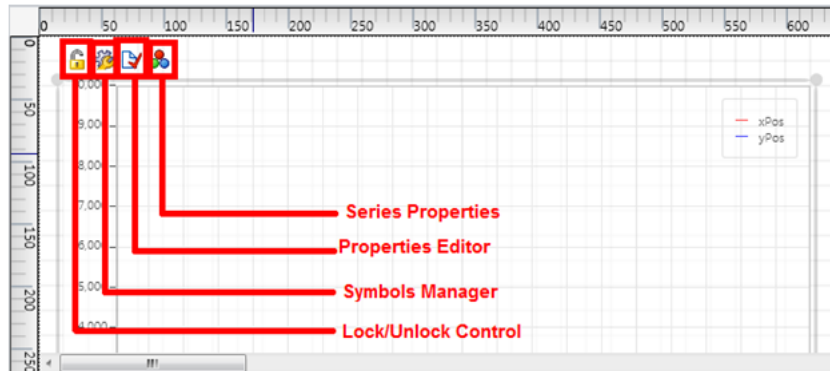
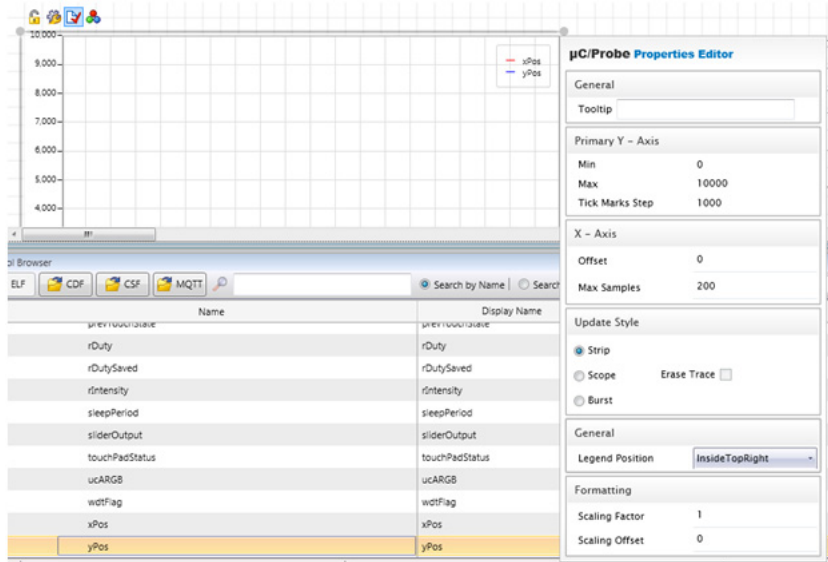

Figure 6-72. Properties Editor of Line chart control



14. In the Properties editor, change the Max property of Y axis to 100.

Notes:

1. You may use the Series properties to change the line graph colors of xPos and yPos.
2. The Symbols Manager shows the global variables associated with the control.

15. Now, connect the CY8CKIT-040 to PC. Click on the Settings button in the µC/Probe tool.

Figure 6-73. Settings button in µC/Probe

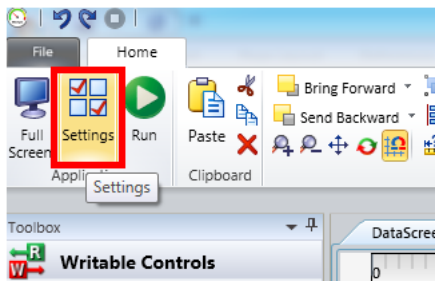

16. In the μ C/Probe setting window, select the Cypress PSoC Prog and select 'KitProg/<Kit Prog number>' from the drop down box for Port and click OK to start communication between the CY8CKIT-040 and the μ C/Probe tool.

Figure 6-74. μ C/Probe Settings

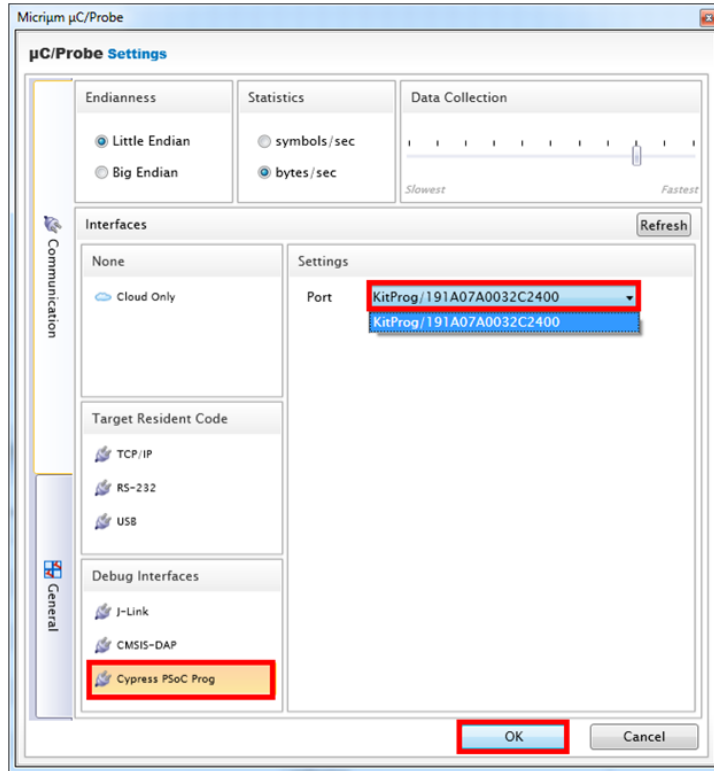

17. Click on Run button to start.

Figure 6-75. Run button



18. Now, move your finger on the trackpad on the kit and observe the Line chart and RGB Palette control output on the datascreen.

Figure 6-76. Line chart and RGB Palette output

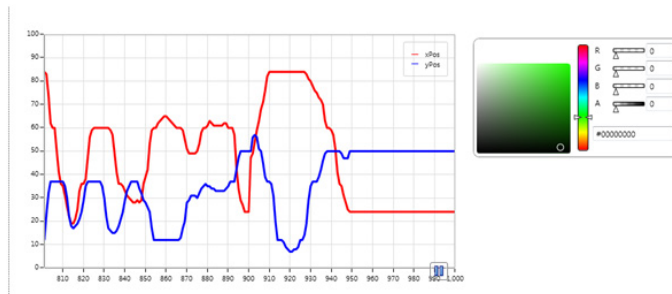

Note: If you are using Education edition of μ C/Probe tool, pop-up windows will be displayed before starting datascreen. Click OK to continue. Also, the Datascreen (output) will time-out after 1 minute in case of Education edition.

- Click on File tab and select Save to save the μ C/Probe project. Provide an appropriate name and select a location to save your project. The μ C/Probe projects are saved with extension .WSPX. Double clicking a .WSPX file opens the μ C/Probe tool.

CY8CKIT_040_Proximity_UART Example project:

The μ C/Probe project for CY8CKIT_040_Proximity_UART project is already created and packaged along with kit content. The μ C/Probe projects can be found in the installation folder at <Install directory>/CY8CKIT-040 PSoC 4000 Pioneer Kit/<version>/uCProbe.

- Open CY8CKIT-040_Proximity_UART example project in PSoC Creator.
- In the System settings in cydwr file of the example project, change the **Debug Select** to **SWD** and build the project. Refer [Figure 5-8 on page 55](#).
- Program the CY8CKIT-040_Proximity_UART example project on CY8CKIT-040 by following steps 1–8 in [Programming the Example Projects on page 51](#).
- Double click on CY8CKIT-040_Proximity_UART.wspcx file.
- Insert a wire loop into the proximity sensor.

Note: Ensure that board is not powered while inserting the wire loop in the sensor. Else, the act of insertion of wire loop causes a shift in baseline and proximity sensor output would be incorrect.

- Connect the CY8CKIT-040 to PC and follow steps 14 to 16 described in CY8CKIT_040_Color_Palette Example Project section to start running the datascreen.
- Move your palm closer to the wire loop. The LED is in OFF state when the proximity is less than 100 and the proximity value is shown on the slider. The LED turns ON when the proximity value is 100.

Figure 6-77. LED and slider control output when away from sensor



Figure 6-78. LED and slider control output at close proximity to sensor



A. Appendix



A.1 CY8CKIT-040 Schematics

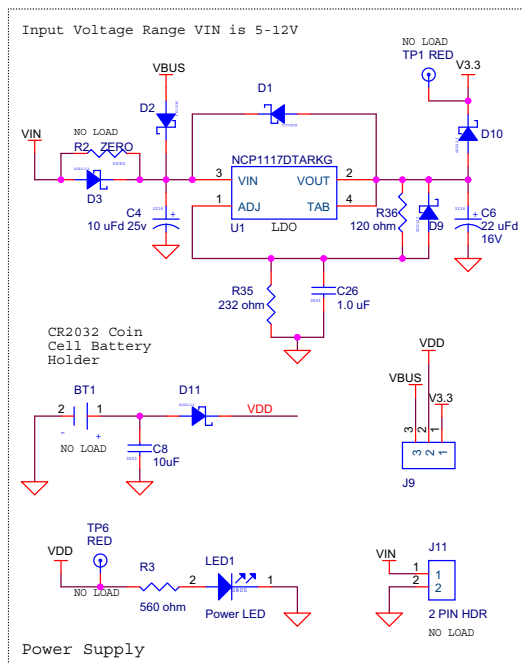

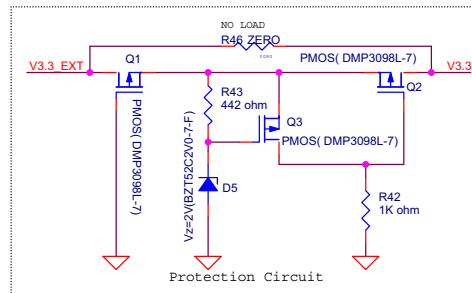
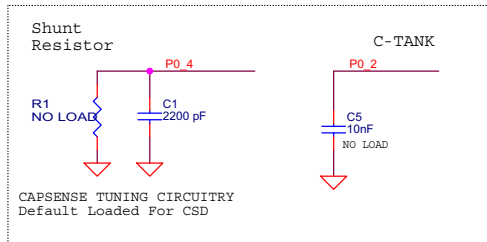
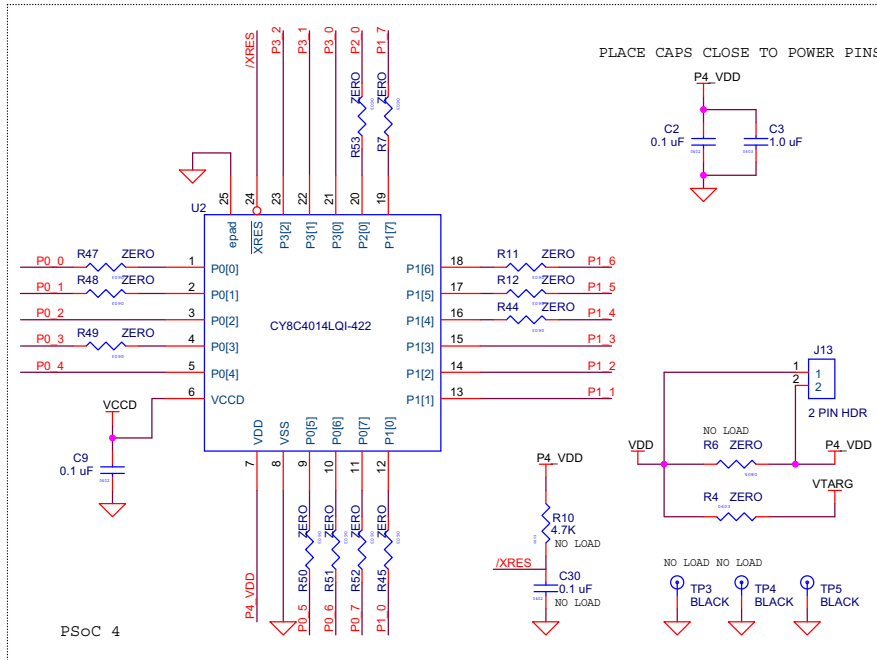

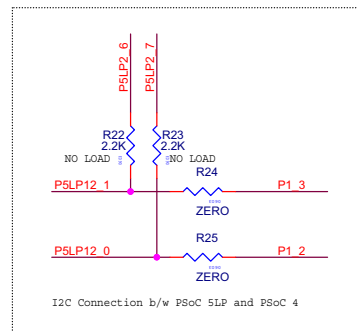
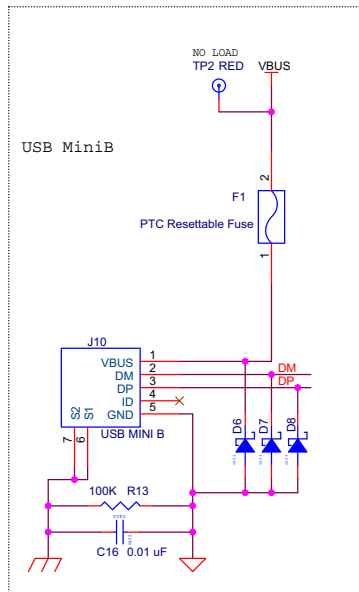
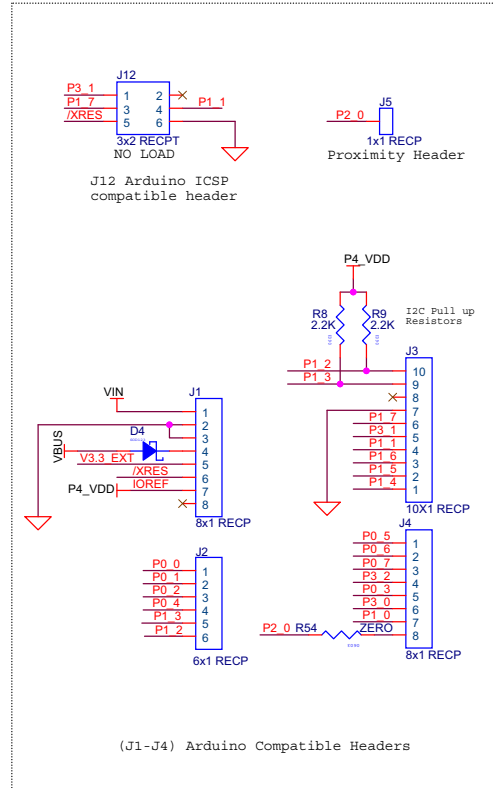
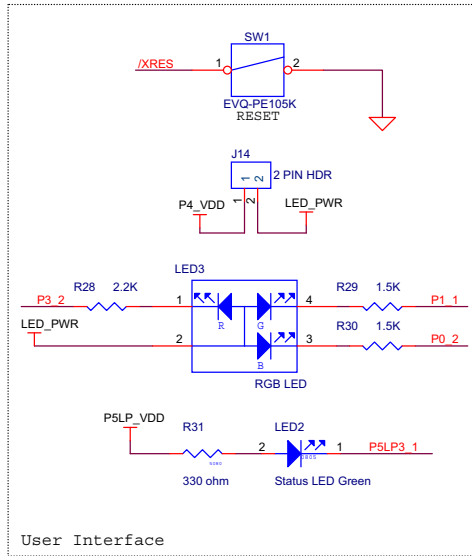

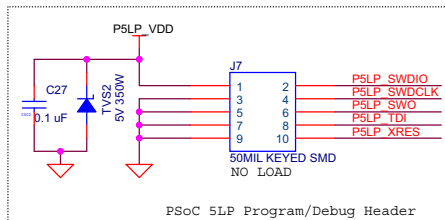
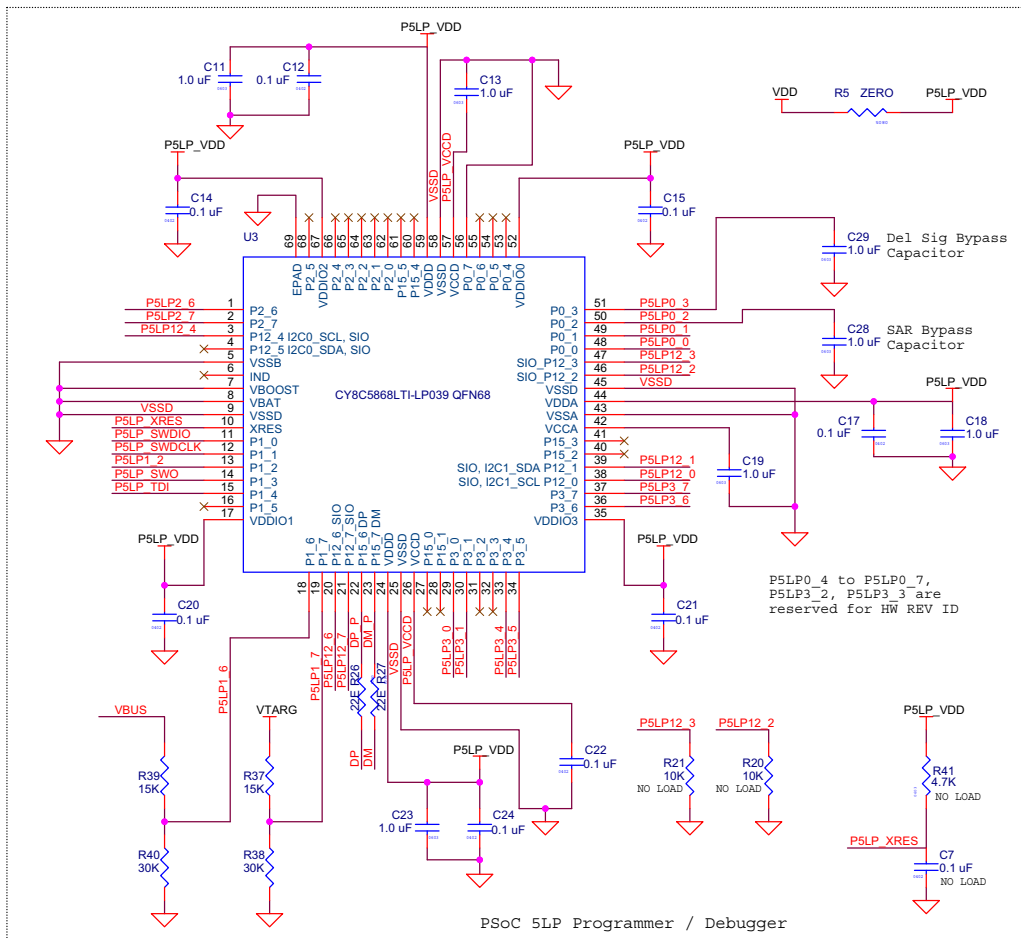
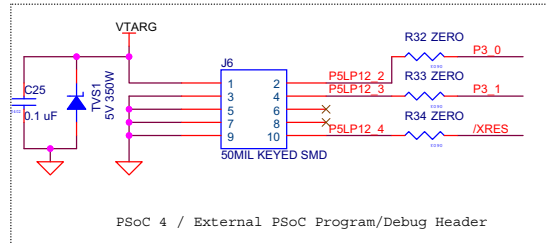
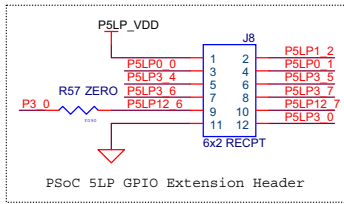

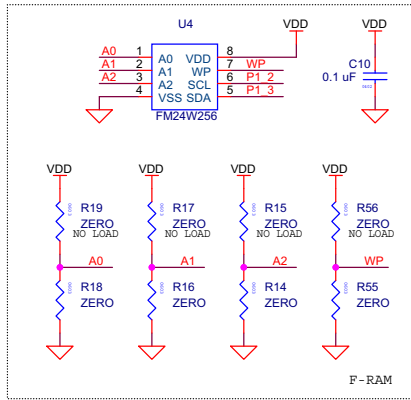

A.1.1 CapSense Touchpad Shield Board

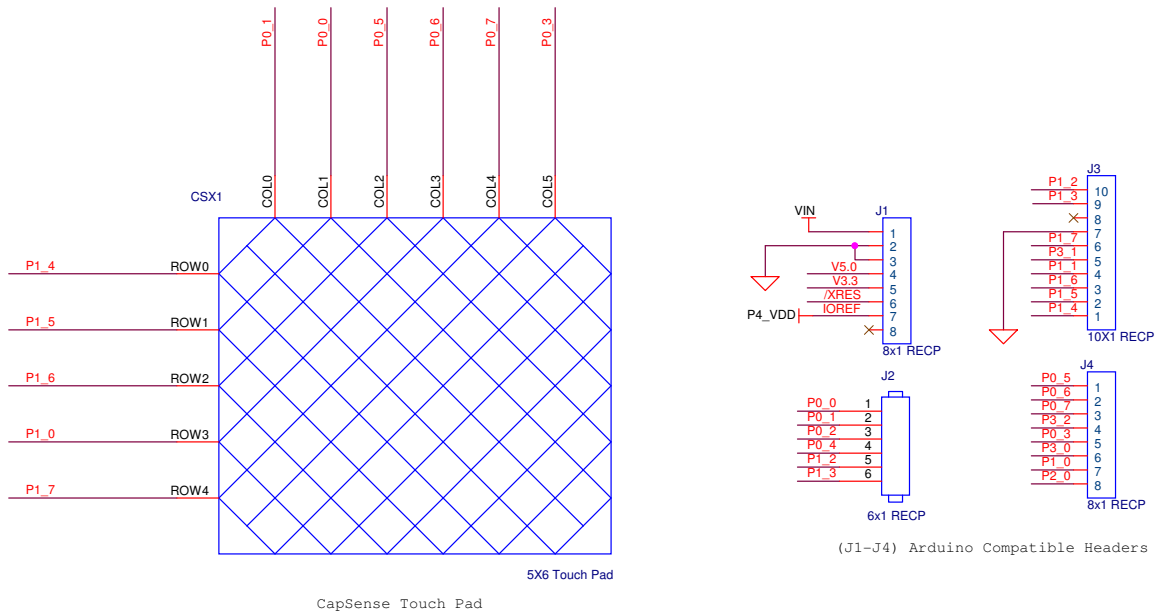

A.2 Pin Assignment Table

This section provides the pin map of the headers and their usage.

A.2.1 Arduino Compatible Headers (J1, J2, J3, J4, and J12)

Power Connector (J1)		
Pin	Baseboard Signal	Trackpad Shield Signal
J1_01	VIN	NC
J1_02	GND	GND
J1_03	GND	GND
J1_04	V5.0	NC
J1_05	V3.3	NC
J1_06	RESET	NC
J1_07	IOREF/P4_VDD	NC
J1_08	NC	NC

J2 Connector		
Pin	Baseboard Signal	Trackpad Shield Signal
J2_01 (A0)	P0[0]	TRACK_COLUMN1
J2_02 (A1)	P0[1]	TRACK_COLUMN0
J2_03 (A2)	P0[2] (TCPWM_LINE/Blue LED, CTANK)	NC
J2_04 (A3)	P0[4] (CMOD)	NC
J2_05 (A4)	P1[3] (SDA)	NC
J2_06 (A5)	P1[2] (SCL)	NC

J3 Connector		
Pin	Baseboard Signal	Trackpad Shield Signal
J3_01 (D8)	P1[4]	TRACK_ROW0
J3_02 (D9)	P1[5]	TRACK_ROW1
J3_03 (D10)	P1[6]	TRACK_ROW2
J3_04 (D11)	P1[1] (TCPWM_LINE/Green LED)	NC
J3_05 (D12)	P3[1] (SWDCK)	NC
J3_06 (D13)	P1[7]	TRACK_ROW4
J3_07	GND	GND
J3_08	NC	NC
J3_09	P1[3] (SDA)	NC
J3_10	P1[2] (SCL)	NC

J4 Connector		
Pin	Baseboard Signal	Trackpad Shield Signal
J4_01 (D0)	P0[5]	TRACK_COLUMN2
J4_02 (D1)	P0[6]	TRACK_COLUMN3
J4_03 (D2)	P0[7]	TRACK_COLUMN4
J4_04 (D3)	P3[2] (TCPWM_LINE, Red LED)	NC
J4_05 (D4)	P0[3]	TRACK_COLUMN5
J4_06 (D5)	P3[0] (SWDIO)	NC
J4_07 (D6)	P1[0]	TRACK_ROW3
J4_08 (D7)	P2[0] (PROX)	NC

J12		
Pin	Kit Signal	PSoC 4 Description
J12_01	P3[1]	GPIO
J12_02	NC	NC
J12_03	P1[7]	GPIO
J12_04	P1[1]	GPIO
J12_05	/XRES	PSoC 4 RESET
J12_06	GND	GND

A.2.2 PSoC 5LP GPIO Header (J8)

J8 is a 2×6 header that connects PSoC 5LP pins to support GPIO controls for custom PSoC 5LP projects.

J8					
Pin	PSoC 5LP Signal	PSoC 5LP Description	Pin	PSoC 5LP Signal	PSoC 5LP Description
J8_01	PSoC 5LP_VDD	VDD	J8_02	P1[2]	Digital I/O
J8_03	P0[0]	Delta Sigma ADC + input	J8_04	P0[1]	Delta Sigma ADC – input
J8_05	P3[4]	SAR – input	J8_06	P3[5]	SAR + input
J8_07	P3[6]	Buffered VDAC	J8_08	P3[7]	Buffered VDAC
J8_09	P12[6]	UART RX	J8_10	P12[7]	UART TX
J8_11	GND	GND	J8_12	P3[0]	IDAC output

A.3 Program and Debug Headers

A.3.1 PSoC 4 Direct Program/Debug Header (J6)

J6							
Pin	PSoC 5LP Signal	PSoC 4 Signal	Description	Pin	PSoC 5LP Signal	PSoC 4 Signal	Description
J6_01	VDD	VDD	VCC	J6_02	P12[2]	P3[0]	TMS/SWDIO
J6_03	GND	GND	GND	J6_04	P12[3]	P3[1]	TCLK/SWCLK
J6_05	GND	GND	GND	J6_06	NC	NC	NC
J6_07	GND	GND	GND	J6_08	NC	NC	NC
J6_09	GND	GND	GND	J6_10	P12[4]	XRES	RESET

A.3.2 PSoC 5LP Direct Program/Debug Header (J7)

J7					
Pin	PSoC 5LP Signal	Description	Pin	PSoC 5LP Signal	Description
J7_01	VDD	VCC	J7_02	P1[0]	TMS/SWDIO
J7_03	GND	GND	J7_04	P1[1]	TCLK/SWCLK
J7_05	GND	GND	J7_06	P1[3]	TDO/SWO
J7_07	GND	GND	J7_08	P1[4]	TDI
J7_09	GND	GND	J7_10	XRES	RESET

A.4 Use of Zero-ohm Resistors and No Load

Unit	Resistor	Usage
Power supply	R2	Solder zero-ohm resistors to access voltage from VBUS (USB).
I ² C connection between PSoC 5LP and PSoC 4	R24 and R25	Unsolder the resistors to communicate with an external PSoC using the PSoC 5LP. Removing these will disable the PSoC 4 I ² C communication with the PSoC 5LP device.
PSoC 4/external PSoC program/debug header	R32, R33, and R34	Unsolder the resistors to disconnect SWD lines from the PSoC 4. Use J6 to connect and program an external PSoC. Removing these will disable PSoC 4 programming by the PSoC 5LP device and through the J6 header.
Protection circuit	R46	Solder zero-ohm resistors to bypass the entire protection circuitry.
CapSense tuning circuitry	R1	Convert IDAC output to a voltage, or used as a bleed resistor to CMOD.
CapSense tuning circuitry/user interface	R30	Unsolder R30, which connects P0[2] to the blue LED to enable shield tank capacitor C5 on P0[2].
PSoC 4	R4, R6	Unsolder R4 to remove supply to VTARG and solder zero-ohm resistors R6 to supply P4_VDD with VDD instead of J13.
PSoC 5LP programmer/debugger	R11, R12, R14, R15, R16	For future use.
	R5	Unsolder the zero-ohm resistor to cut the VDD supply to PSoC 5LP.
	R7	For future use.
F-RAM	R14, R15, R16, R17, R18, and R19	Select the lower three bits of the F-RAM I ² C slave address. R14-R15 selects bit 2 (A2), R16-R17 selects bit 1 (A1), and R18-R19 selects bit 0 (A0). The selected bits are OR'ed with the F-RAM family's I ² C address (0x50) to decide the slave address for the one on the board.
	R56 and R55	Solder a zero-ohm resistor for R56 to write-protect the entire F-RAM memory. R55 is not required to be populated as the WP pin is internally pulled down. When the WP pin is left floating or R55 is populated, write access to F-RAM is restored.
PSoC 5LP GPIO header	R57	Unsolder the zero-ohm resistor to disconnect P3[0] from the PSoC 5LP RX line and use P3[0] for PSoC 4 debug or PSoC 5LP as a USB-UART bridge for another device.

A.5 KitProg Status LED States

	User Indication	Scenario	Action Required by user
1	LED blinks fast: Frequency = 4.00 Hz	LED starts blinking at power up, if bootloadable file is corrupt.	Bootload the <i>KitProg.cyacd</i> file: in PSoC Programmer, connect to the kit, open the Utilities tab and press Upgrade Firmware button.
2	LED blinks slow: Frequency = 0.67 Hz	Entered Bootloader mode by holding the BLE Pioneer Kit/BLE Dongle Reset button during kit power-up.	Release the Reset button and re-plug power if you entered this mode by mistake. If the mode entry was intentional, bootload the new.cycad file using the Bootloader Host tool shipped with PSoC Creator.
3	LED blinks very fast: Frequency = 15.0 Hz	SWD operation is in progress. Any I2C traffic. Kit's COM port connect/disconnect event (one blink).	In PSoC Programmer, watch the log window for status messages for SWD operations. In the Bridge Control Panel, the LED blinks on I2C command requests. In BCP or any other serial port terminal program, distinguish the kit's COM port number by the blinking LED when the port is connected or disconnected.
4	LED is ON.	USB enumeration successful. Kit is in the idle state waiting for commands.	The kit functions can be used by PSoC Creator, PSoC Programmer, Bridge Control Panel, and any serial port terminal program.
5	LED is OFF.	Power LED is ON.	This means that the USB enumeration was unsuccessful. This can happen if the kit is not powered from the USB host or the kit is not connected to the USB host through the USB cable. Verify the USB cable and check if PSoC Programmer is installed on the PC.

Note: LED status is not applicable when a custom project is running in PSoC 5LP.

A.6 Bill of Materials

A.6.1 CY8CKIT-040 Baseboard

No.	Qty	Reference	Value	Description	Manufacturer	Mfr Part Number
1				PCB, 68.58 mm x 53.34 mm, High Tg, ENIG finish, 4 layer, Color = RED, Silk = WHITE.	Cypress	
2	1	C1	2200 pFd	CAP CER 2200PF 50V 5% NP0 0805	Murata	GRM2165C1H222JA01D
3	13	C2,C9,C10,C12,C14,C15,C17,C20,C21,C22,C24,C25,C27	0.1 uFd	CAP .1UF 16V CERAMIC Y5V 0402	Panasonic - ECG	ECJ-0EF1C104Z
4	9	C3,C11,C13,C18,C19,C23,C26,C28,C29	1.0 uFd	CAP CERAMIC 1.0UF 25V X5R 0603 10%	Taiyo Yuden	TMK107BJ105KA-T
5	1	C4	10 uF 25V	CAP TANT 10UF 25V 10% 1210	AVX Corporation	TPSB106K025R1800
6	1	C6	22 uF 16V	CAP TANT 22UF 16V 10% 1210	AVX Corporation	TPSB226K016R0600
7	1	C16	0.01 uFd	CAP 10000PF 16V CERAMIC 0402 SMD	Panasonic - ECG	ECJ-0EB1C103K
8	1	C8	10uFd	CAP CER 10UF 6.3V 20% X5R 0603	Samsung Electro-Mechanics America, Inc	CL10A106MQ8NNNC
9	7	D1,D2,D3,D4,D9,D10,D11	MBR05	DIODE SCHOTTKY 0.5A 20V SOD-123	Fairchild Semiconductor	MBR0520L
10	1	LED1	Power LED Amber	LED 595NM AMB DIFF 0805 SMD	Avago Technologies	HSMA-C170
11	1	D5	2V Zener	DIODE ZENER 2V 500MW SOD123	Diodes Inc	BZT52C2V0-7-F
12	3	D6, D7, D8	ESD diode	SUPPRESSOR ESD 5VDC 0603 SMD	Bourns Inc.	CG0603MLC-05LE
13	1	LED3	RGB LED	LED RED/GREEN/BLUE PLCC4 SMD	Cree, Inc.	CLV1A-FKB-CJ1M1F1BB7R4S3
14	1	LED2	Status LED Green	LED GREEN CLEAR 0805 SMD	Chicago Miniature	CMD17-21VGC/TR8
15	1	F1	FUSE	PTC Resettable Fuses 15Volts 100Amps	Bourns	MF-MSMF050-2
16	2	J1, J4	8x1 RECP	CONN HEADER FEMALE 8POS .1" GOLD	Sullins Connector Solutions	PPPC081LFBN-RC
17	1	J2	6x1 RECP	CONN HEADER FMAL 6POS.1" GOLD	Sullins Connector Solutions	PPPC061LFBN-RC
18	1	J3	10x1 RECP	CONN HEADER FMALE 10POS .1" GOLD	Sullins Connector Solutions	PPPC101LFBN-RC
19	1	J5	1X1 RECP	CONN RCPT 1POS .100" SNGL HORZ	Samtec Inc	BCS-101-L-S-HE
20	1	J6	50MIL KEYED SMD	CONN HEADER 10 PIN 50MIL KEYED SMD	Samtec	FTSH-105-01-L-DV-K
21	1	J8	6x2 RECP	CONN HEADER FMAL 12PS.1" DL GOLD	Sullins Connector Solutions	PPPC062LFBN-RC
22	1	J9	3p_jumper	CONN HEADER VERT SGL 3POS GOLD	3M	961103-6404-AR
23	1	J10	USB MINI B	CONN USB RECEPTACLE 5POS RT ANG	Molex Inc	0548190519

No.	Qty	Reference	Value	Description	Manufacturer	Mfr Part Number
24	2	J13,J14	2p_jumper	CONN HEADER VERT SGL 2POS GOLD	3M	961102-6404-AR
25	3	Q1,Q2,Q3	PMOS	MOSFET P-CH 30V 3.8A SOT23-3	Diodes Inc	DMP3098L-7
26	1	R3	560 ohm	RES 560 OHM 1/8W 5% 0805 SMD	Panasonic - ECG	ERJ-6GEYJ561V
27	24	R4,R7,R11,R12,R14,R16,R18,R24,R25,R32,R33,R34,R44,R45,R47,R48,R49,R50,R51,R52,R53,R54,R55,R57	ZERO	RES 0.0 OHM 1/10W 0603 SMD	Panasonic-ECG	ERJ-3GEY0R00V
28	1	R5	ZERO	RES 0.0 OHM 1/8W 0805 SMD	Panasonic-ECG	ERJ-6GEY0R00V
29	4	R8,R9	2.2K	RES 2.2K OHM 1/10W 5% 0603 SMD	Panasonic - ECG	ERJ-3GEYJ222V
30	1	R13	100K	RES 100K OHM 1/10W 5% 0402 SMD	Panasonic - ECG	ERJ-2GEJ104X
31	2	R26, R27	22E	RES 22 OHM 1/10W 1% 0603 SMD	Panasonic - ECG	ERJ-3EKF22R0V
32	1	R28	2.2K	RES 2.2K OHM 1/8W 5% 0805 SMD	Panasonic - ECG	ERJ-6GEYJ222V
33	2	R29,R30	1.5K	RES 1.5K OHM 1/8W 5% 0805 SMD	Panasonic - ECG	ERJ-6GEYJ152V
34	1	R31	330 ohm	RES 330 OHM 1/8W 5% 0805 SMD	Panasonic - ECG	ERJ-6GEYJ331V
35	1	R35	232 ohm	RES 232 OHM 1/10W 1% 0603 SMD	Panasonic - ECG	ERJ-3EKF2320V
36	1	R36	120 ohm	RES 120 OHM 1/10W 1% 0603 SMD	Panasonic - ECG	ERJ-3EKF1200V
37	2	R37,R39	15K	RES 15K OHM 1/10W 5% 0603 SMD	Panasonic - ECG	ERJ-3GEYJ153V
38	2	R38,R40	30K	RES 30K OHM 1/10W 5% 0603 SMD	Panasonic - ECG	ERJ-3GEYJ303V
39	1	R42	1K	RES 1K OHM 1/8W 5% 0805 SMD	Panasonic - ECG	ERJ-6GEYJ102V
40	1	R43	442 ohm	RES 442 OHM 1/10W 1% 0603 SMD	Panasonic - ECG	ERJ-3EKF4420V
41	1	SW1	SW PUSHBUT-TON	SWITCH TACTILE SPST-NO 0.05A 12V	Panasonic - ECG	EVQ-PE105K
42	1	TP5	BLACK	TEST POINT PC MINI .040"D Black	Keystone Electronics	5001
43	2	TVS1,TVS2	5V 350W	TVS UNIDIR 350W 5V SOD-323	Diodes Inc.	SD05-7
44	1	U1	NCP1117DTAR KG	NCP1117DTARKG	ON Semiconductor	NCP1117DTARKG
45	1	U2	PSoC 4 S0 (CY8C400)	24 QFN PSoC4 S0 target chip	Cypress Semiconductor	CY8C4014LQI-422
46	1	U3	PSoC 5LP (CY8C5868LTI-LP039)	68QFN PSoC 5LP chip for USB debug channel and USB-Serial interface	Cypress Semiconductor	CY8C5868LTI-LP039
47	1	U4	F-RAM	F-RAM with I ² C interface	Cypress Semiconductor	FM24W256-G
No Load Components						
48	1	BT1	Coin Cell Battery Holder	HOLDER CR2032 GOLD LEADS SMD	MPD	BU2032SM-BT-GTR
49	1	C5	10000 pFd	CAP CER 10000PF 50V 5% NP0 0805	Murata	GRM2195C1H103JA01D
50	2	C7,C30	0.1 uFd	CAP .1UF 16V CERAMIC Y5V 0402	Panasonic - ECG	ECJ-0EF1C104Z
51	1	J7	50MIL KEYED SMD	CONN HEADER 10 PIN 50MIL KEYED SMD	Samtec	FTSH-105-01-L-DV-K
52	1	J11	2 PIN HDR	CONN HEADER FEMALE 2POS .1" GOLD	Sullins Connector Solutions	PPPC021LFBN-RC
53	1	J12	3X2 RECP	CONN HEADER .100 DUAL STR 12POS	Sullins Connector Solutions	PBC06DFAN

No.	Qty	Reference	Value	Description	Manufacturer	Mfr Part Number
54	7	R1,R2,R15,R17, R19,R46,R56	ZERO	RES 0.0 OHM 1/10W 0603 SMD	Panasonic-ECG	ERJ-3GEY0R00V
55	1	R6	ZERO	RES 0.0 OHM 1/8W 0805 SMD	Panasonic-ECG	ERJ-6GEY0R00V
56	2	R10,R41	4.7K	RES 4.7K OHM 1/10W 5% 0603 SMD	Panasonic-ECG	ERJ-3GEYJ472V
57	2	R20,R21	10K	RES 10K OHM 1/10W 5% 0603 SMD	Panasonic - ECG	ERJ-3GEYJ103V
58	2	R22,R23	2.2K	RES 2.2K OHM 1/10W 5% 0603 SMD	Panasonic - ECG	ERJ-3GEYJ222V
59	3	TP1,TP2,TP6	RED	TEST POINT PC MINI .040"D RED	Keystone Electronics	5000
60	2	TP3,TP4	BLACK	TEST POINT PC MINI .040"D Black	Keystone Electronics	5001
Install on Bottom of PCB As per the Silk Screen in the Corners						
61	4	N/A	N/A	BUMPON CYLINDRICAL .312X.215 BLACK	3M	SJ61A6
Special Jumper Installation Instructions						
62	1	J9	Install jumper across pins 1 and 2	Rectangular Connectors MINI JUMPER GF 6.0MM CLOSE TYPE BLACK	Kobiconn	151-8010-E
63	1	J13	Install jumper across pins 1 and 2	Rectangular Connectors MINI JUMPER GF 6.0MM CLOSE TYPE BLACK	Kobiconn	151-8010-E
64	1	J14	Install jumper across pins 1 and 2	Rectangular Connectors MINI JUMPER GF 6.0MM CLOSE TYPE BLACK	Kobiconn	151-8010-E

A.6.2 CY8CKIT-040 Trackpad Shield Board

No.	Qty.	Reference	Value	Description	Manufacturer	Mfr Part Number
1				PCB, 53.34 mm x 53.34 mm, High Tg, ENIG finish, 2 layer, Color = RED, Silk = WHITE.	Cypress	
2	2	J1,J4	CON8	CONN HEADER 8POS .100 STR 30AU	FCI	68001-108HLF
3	1	J2	CON6	CONN HEADER 6POS .100 STR 30AU	FCI	68001-106HLF
4	1	J3	CON10	CONN HEADER 10POS .100 STR 30AU	FCI	68001-110HLF

A.7 Trackpad/Touchpad Sticker Details

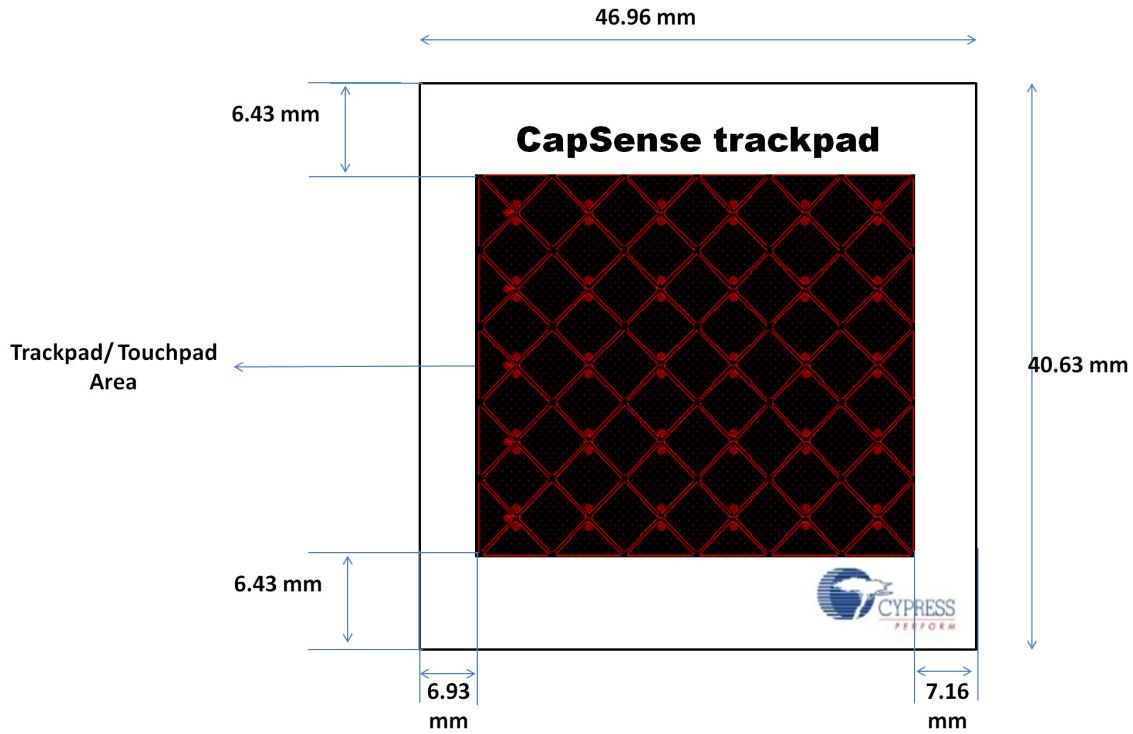

A.8 Regulatory Compliance Information

The CY8CKIT-040 PSoC 4000 Pioneer Kit has been tested and verified to comply with the following electromagnetic compatibility (EMC) regulations:

- EN 55022:2010 Class A - Emissions
- EN 55024:2010 Class A - Immunity

A.9 Migrating projects across different Pioneer series kits

All Cypress Pioneer series kits are Arduino Uno compatible and have some common on-board peripherals such as RGB LED, CapSense and User Switch. However, the pin mapping in each of the boards is different due to differences in pin functions of the PSoC device used. This guide lists the pin maps of the Pioneer series kits to allow for easy migration of projects across different kits.

In some cases, the pins available on the Pioneer kit headers are a superset of the standard Arduino Uno pins. For example J2 contains only 1 row of pins on the Arduino Uno pinout while it contains 2 rows of pins on many of the Pioneer series kits.

Figure A-1. Pioneer series kits pin map

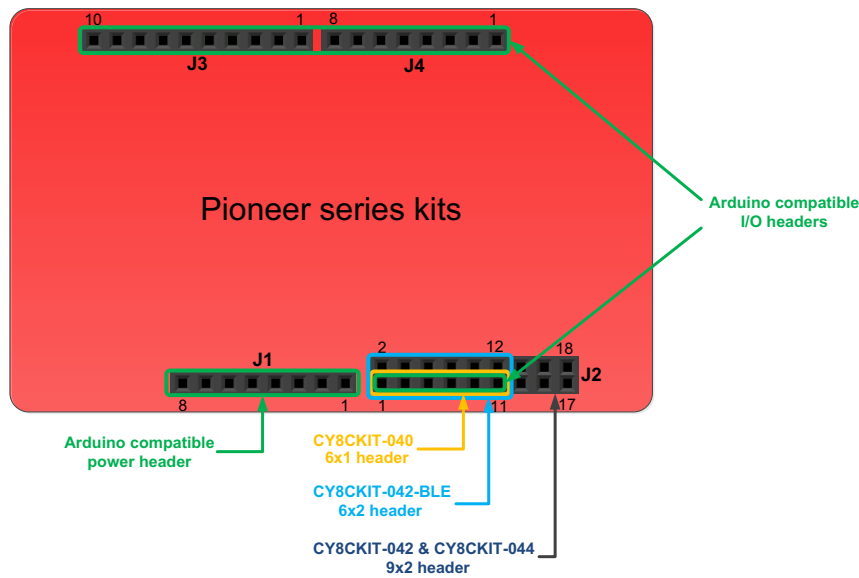

A.9.1 Arduino Uno Compatible Headers

J1 Arduino Compatible Header Pin Map					
Pin #	Arduino Pin	Pioneer series kits			
		CY8CKIT-042	CY8CKIT-040	CY8CKIT-042-BLE	CY8CKIT-044
1	VIN	VIN	VIN	VIN	VIN
2	GND	GND	GND	GND	GND
3	GND	GND	GND	GND	GND
4	5V	V5.0	V5.0	V5.0	V5.0
5	3.3V	V3.3	V3.3	V3.3	V3.3
6	RESET	RESET	RESET	RESET	RESET
7	IOREF	P4.VDD	P4.VDD	BLE.VDD	P4.VDD
8	NC	NC	NC	NC	NC

J2 Arduino Compatible Header Pin Map					
Pin #	Arduino Pin	Pioneer series kits			
		CY8CKIT-042	CY8CKIT-040	CY8CKIT-042-BLE	CY8CKIT-044
1	A0	P2[0]	P0[0]	P3[0]	P2[0]
2	–	P0[2]*	–	P2[0]	P2[6]*
3	A1	P2[1]	P0[1]	P3[1]	P2[1]
4	–	P0[3]*	–	P2[1]*	P6[5]*
5	A2	P2[2]	P0[2]*	P3[2]	P2[2]
6	–	P4_VDD	–	P2[2]*	P0[6]*
7	A3	P2[3]	P0[4]*	P3[3]	P2[3]
8	–	P1[5]*	–	P2[3]*	P4[4]*
9	A4	P2[4]	P1[3]	P3[4]	P2[4]
10	–	P1[4]*	–	P2[4]*	P4[5]*
11	A5	P2[5]	P1[2]	P3[5]	P2[5]
12	–	P1[3]*	–	P2[5]*	P4[6]*
13	–	P0[0]	–	–	P0[0]
14	–	GND	–	–	GND
15	–	P0[1]	–	–	P0[1]
16	–	P1[2]*	–	–	P3[4]*
17	–	P1[0]	–	–	P0[7]*
18	–	P1[1]*	–	–	P3[5]*

* These pins are also used for on-board peripherals. See the tables in the On-Board Peripherals section below for details.

J3 Arduino Compatible Header Pin Map					
Pin #	Arduino Pin	Pioneer series kits			
		CY8CKIT-042	CY8CKIT-040	CY8CKIT-042-BLE	CY8CKIT-044
1	D8	P2[6]	P1[4]	P0[5]	P0[2]
2	D9	P3[6]	P1[5]	P0[4]	P0[3]
3	D10	P3[4]	P1[6]	P0[2]	P2[7]
4	D11	P3[0]	P1[1]*	P0[0]	P6[0]
5	D12	P3[1]	P3[1]	P0[1]	P6[1]
6	D13	P0[6]	P1[7]	P0[3]	P6[2]
7	GND	GND	GND	GND	GND
8	AREF	P1[7]	NC	VREF	P1[7]
9	SDA	P4[1]	P1[3]	P3[4]	P4[1]
10	SCL	P4[0]	P1[2]	P3[5]	P4[0]

* These pins are also used for on-board peripherals. See the tables in the On-Board Peripherals section below for connection details.

J4 Arduino Compatible Header Pin Map					
Pin #	Arduino Pin	Pioneer series kits			
		CY8CKIT-042	CY8CKIT-040	CY8CKIT-042-BLE	CY8CKIT-044
1	D0	P0[4]	P0[5]	P1[4]	P3[0]
2	D1	P0[5]	P0[6]	P1[5]	P3[1]
3	D2	P0[7]*	P0[7]	P1[6]	P1[0]
4	D3	P3[7]	P3[2]*	P1[7]	P1[1]
5	D4	P0[0]	P0[3]	P1[3]	P1[2]
6	D5	P3[5]	P3[0]	P1[2]	P1[3]
7	D6	P1[0]	P1[0]	P1[1]	P5[3]
8	D7	P2[7]	P2[0]*	P1[0]	P5[5]

* These pins are also used for on-board peripherals. See the tables in the On-Board Peripherals section below for connection details.

A.9.2 On-Board Peripherals

CapSense Pin Map					
Pin #	Description	Pioneer series kits			
		CY8CKIT-042 (Linear Slider)	CY8CKIT-040	CY8CKIT-042-BLE (Linear Slider)	CY8CKIT-044 (Gesture Pad)
1	CSS1	P1[1]	–	P2[1]	P4[4]
2	CSS2	P1[2]	–	P2[2]	P4[5]
3	CSS3	P1[3]	–	P2[3]	P4[6]
4	CSS4	P1[4]	–	P2[4]	P3[4]
5	CSS5	P1[5]	–	P2[5]	P3[5]
6	CMOD	P4[2]	P0[4]	P4[0]	P4[2]
7	CTANK	P4[3]	P0[2]	P4[1]	P4[3]

Proximity header Pin Map					
Pin #	Description	Pioneer series kits			
		CY8CKIT-042	CY8CKIT-040	CY8CKIT-042-BLE	CY8CKIT-044
1	PROXIMITY	–	P2[0]	P2[0]	P3[7]
2		–	–	–	P3[6]

RGB LED Pin Map					
Pin #	Color	Pioneer series kits			
		CY8CKIT-042	CY8CKIT-040	CY8CKIT-042-BLE	CY8CKIT-044
1	Red	P1[6]	P3[2]	P2[6]	P0[6]
2	Green	P0[2]	P1[1]	P3[6]	P2[6]
3	Blue	P0[3]	P0[2]	P3[7]	P6[5]

User Switch Pin Map					
Pin #	Description	Pioneer series kits			
		CY8CKIT-042	CY8CKIT-040	CY8CKIT-042-BLE	CY8CKIT-044
1	SW2	P0[7]	–	P2[7]	P0[7]

Revision History



Table 7-1. CY8CKIT-040 PSoC® 4000 Pioneer Kit Guide Revision History

Document Title: CY8CKIT-040 PSoC® 4000 Pioneer Kit Guide				
Document Number: 001-91316				
Revision	ECN#	Issue Date	Origin of Change	Description of Change
**	4363580	04/21/2014	RKAD	New kit guide.
*A	4681349	03/09/2015	SASH	Updated Introduction chapter on page 7: Updated “ Additional Learning Resources ” on page 13: Updated “ Learning PSoC Creator ” on page 10: Updated Figure “ Example Projects ”. Updated description. Updated Figure “ Starter Designs ”. Updated “ Application Notes ” on page 12: Updated description.
				Updated Software Installation chapter on page 15: Updated “ Install Software ” on page 15: Removed figure “ Kit Software Download Options ”.
				Updated Kit Operation chapter on page 19: Updated “ Kit USB Connection ” on page 21: Updated Table 3-1 : Updated entire table.
				Updated Hardware chapter on page 31: Updated “ Board Details ” on page 31: Updated description. Updated “ Kit Component Details ” on page 35: Updated “ CY8CKIT-040 Baseboard Components ” on page 35: Updated “ Power Supply System ” on page 38: Updated Figure 4-5 . Updated description.

Table 7-1. CY8CKIT-040 PSoC® 4000 Pioneer Kit Guide Revision History (continued)

Document Title: CY8CKIT-040 PSoC® 4000 Pioneer Kit Guide				
Document Number: 001-91316				
Revision	ECN#	Issue Date	Origin of Change	Description of Change
*A (cont.)	4681349	03/09/2015	SASH	Updated Code Examples chapter on page 51: Updated "Project: Blinking LED" on page 56: Updated "Project Description" on page 57: Updated "PSoC Creator Component Configuration" on page 57: Updated Figure 5-10 . Updated "Hardware Connections" on page 58: Updated Figure 5-12 . Updated "Project Description" on page 60: Updated "Firmware Details" on page 63: Updated description. Updated "Hardware Connections" on page 68: Updated Figure 5-18 . Updated "Project: CapSense Touchpad with I2C Tuner" on page 76: Updated "Project Description" on page 78: Updated "PSoC Creator Component Configuration" on page 78: Updated Figure 5-29 . Updated "Hardware Connections" on page 80: Updated Figure 5-32 . Updated "Verify Output" on page 81: Updated "Launching Tuner Window" on page 81: Updated Figure 5-34 . Updated Figure 5-35 . Updated "Verify Output" on page 83: Updated Figure 5-38 . Updated Figure 5-39 . Updated Figure 5-40 . Updated "Project: Color Palette" on page 86: Updated "Project Description" on page 86: Updated "PSoC Creator Component Configuration" on page 86: Updated Figure 5-42 . Updated "Hardware Connections" on page 100: Updated Figure 5-54 .

Table 7-1. CY8CKIT-040 PSoC® 4000 Pioneer Kit Guide Revision History (continued)

Document Title: CY8CKIT-040 PSoC® 4000 Pioneer Kit Guide				
Document Number: 001-91316				
Revision	ECN#	Issue Date	Origin of Change	Description of Change
*A (cont.)	4681349	03/09/2015	SASH	<p>Updated Advanced Topics chapter on page 107: Updated description.</p> <p>Updated “Using PSoC 5LP as a USB-I2C Bridge” on page 107: Updated Figure 6-1. Updated Figure 6-4. Updated Figure 6-5. Updated Figure 6-6. Updated Figure 6-7.</p> <p>Updated “Using FM24W256 F-RAM” on page 115: Updated “Example Firmware” on page 117: Updated Figure 6-16. Updated Figure 6-17. Updated Figure 6-18.</p> <p>Updated “Using PSoC 5LP as a USB-UART Bridge” on page 120: Updated Figure 6-21. Updated Figure 6-22. Updated Figure 6-23. Updated Figure 6-25. Updated Figure 6-27.</p> <p>Updated “Developing Applications for PSoC 5LP” on page 133: Updated “Building a Bootloadable Project for PSoC 5LP” on page 134: Updated description. Updated Figure 6-42. Updated Figure 6-43. Updated Figure 6-48. Updated Figure 6-49. Updated Figure 6-50.</p> <p>Updated “Building a Normal Project for PSoC 5LP” on page 142: Updated Figure 6-53. Updated “PSoC 5LP Factory Program Restore Instructions” on page 144: Updated “PSoC 5LP Programmed with a Bootloadable Application” on page 144: Updated “Restore PSoC 5LP Factory Program Using USB Host Tool” on page 148: Updated description. Added “Using μC/Probe Tool” on page 152.</p> <p>Updated Appendix chapter on page 161: Updated “KitProg Status LED States” on page 170: Changed heading from “Error in Firmware/Status Indication in Status LED” to “KitProg Status LED States”. Updated entire section.</p>

Table 7-1. CY8CKIT-040 PSoC® 4000 Pioneer Kit Guide Revision History (continued)

Document Title: CY8CKIT-040 PSoC® 4000 Pioneer Kit Guide				
Document Number: 001-91316				
Revision	ECN#	Issue Date	Origin of Change	Description of Change
*B	4665701	04/07/2015	SASH	Updated Introduction chapter on page 7: Updated "Technical Support" on page 14: Updated description.
				Updated Software Installation chapter on page 15: Updated "Install Software" on page 15: Updated description.
				Updated Kit Operation chapter on page 19: Updated "Kit USB Connection" on page 21: Updated description. Removed figure "KitProg Driver Installation".
				Updated Advanced Topics chapter on page 107: Updated "Using FM24W256 F-RAM" on page 115: Updated "Example Firmware" on page 117: Updated Figure 6-17 . Updated Figure 6-18 . Updated "Using PSoC 5LP as a USB-UART Bridge" on page 120: Updated Figure 6-25 . Updated Figure 6-27 . Updated "Developing Applications for PSoC 5LP" on page 133: Updated "Building a Bootloadable Project for PSoC 5LP" on page 134: Updated description. Added Figure 6-47 . Updated Figure 6-50 . Updated "Using μ C/Probe Tool" on page 152: Updated description.
				Updated Appendix chapter on page 161: Added "Migrating projects across different Pioneer series kits" on page 175 .
				Updated Introduction chapter on page 7: Updated "PSoC Creator" on page 9: Updated entire section. Updated "Additional Learning Resources" on page 13: Updated entire section.
				Updated Code Examples chapter on page 51: Renamed "Example Projects" with "Code Examples" in chapter heading. Updated "Overview" on page 51: Updated description. Added "ADC in PSoC 4000" on page 104.
*C	4802100	06/18/2015	MSUR	Updated Introduction chapter on page 7: Updated "PSoC Creator" on page 9: Updated entire section. Updated "Additional Learning Resources" on page 13: Updated entire section.