

Quad comparator

BA10339 / BA10339F / BA10339FV

The BA10339, BA10339F, and BA10339FV each consist of four comparators in a single package. The open collector output allows a wired OR connection.

These products feature a wide range of operating power supply voltages, from 3 to 36V with single power supply operation, and from ± 1.5 to $\pm 18V$ with dual power supply operation. Available packages include 14-pin DIP (BA10339), 14-pin SOP (BA10339F), and 14-pin SSOP-B (BA10339FV).

●Features

- 1) Wide range of operating voltages (single power supply: 3 to 36V; dual power supply: ± 1.5 to $\pm 18V$)
- 2) Low current dissipation (0.8mA typ., $V_{CC} = 5V$)
- 3) Low input offset current (5nA typ., $V_{CC} = 5V$) and input offset voltage (2mV typ., $V_{CC} = 5V$)
- 4) Wide common-mode input voltage range (0 to $V_{CC} - 1.5V$).
- 5) Open collector output.

●Block diagram and internal circuit configuration

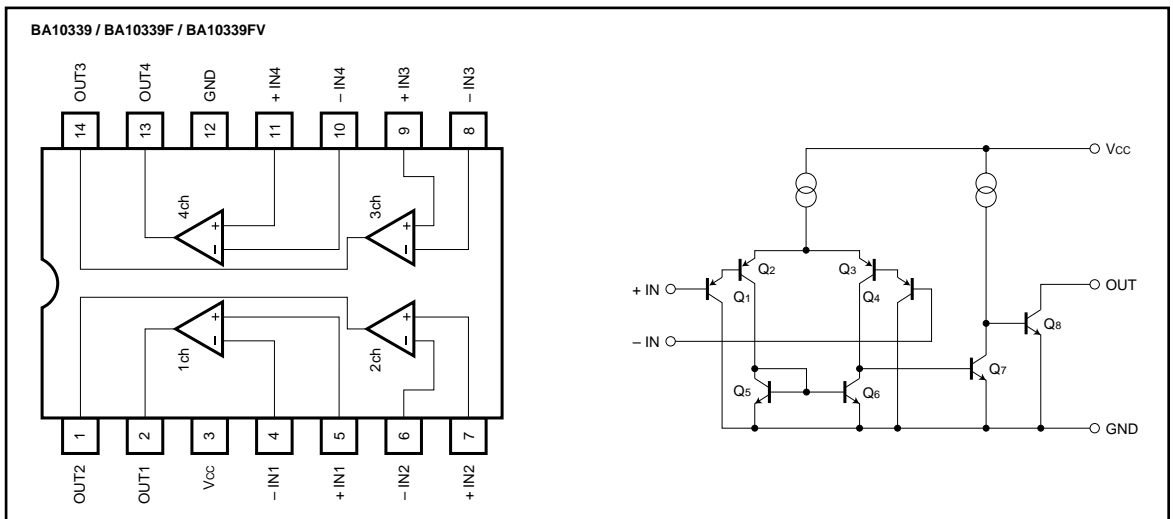

● Absolute maximum ratings (Ta = 25°C)

Parameter	Symbol	Limits			Unit
		BA10339	BA10339F	BA10339FV	
Power supply voltage	V _{CC}	36 (± 18)	36 (± 18)	36 (± 18)	V
Power dissipation	P _d	950*	450*	400*	mW
Differential input voltage	V _{ID}	± V _{CC}	± V _{CC}	± V _{CC}	V
Common-mode input voltage	V _I	- 0.3 ~ V _{CC}	- 0.3 ~ V _{CC}	- 0.3 ~ V _{CC}	V
Operating temperature	T _{opr}	- 40 ~ + 85	- 40 ~ + 85	- 40 ~ + 85	°C
Storage temperature	T _{stg}	- 55 ~ + 125	- 55 ~ + 125	- 55 ~ + 125	°C

* Refer to the Pd characteristic diagram.

* The Values for BA10339F and BA10339FV are those when it is mounted on a glass epoxy board (50mm × 50mm × 1.6mm).

● Electrical characteristics (unless otherwise noted, Ta = 25°C, V_{CC} = + 5V)

Parameter	Symbol	Min.	Typ.	Max.	Unit	Conditions
Input offset voltage	V _{IO}	—	2	5	mV	V _O = 1.4V
Input offset current	I _{IO}	—	5	50	nA	I _{IN+} - I _{IN-} , V _O = 1.4V
Input bias current	I _B	—	25	250	nA	V _O = 1.4V
Common-mode input voltage	V _{ICM}	0	—	V _{CC} - 1.5	V	—
Voltage gain	A _V	—	106	—	dB	R _L = 15kΩ
Quiescent current	I _Q	—	0.8	2	mA	R _L = ∞, on All Comparators
Output sink current	I _{sink}	6	16	—	mA	V _{IN-} = 1V, V _{IN+} = 0V, V _O = 1.5V
Output saturation voltage	V _{OL}	—	250	400	mV	V _{IN-} = 1V, V _{IN+} = 0V, I _{sink} = 3mA
Output leakage current	I _{leak}	—	0.1	—	nA	V _{IN+} = 1V, V _{IN-} = 0V, V _O = 5V
Response time	t _r	—	1.3	—	μs	R _L = 5.1kΩ, V _{RL} = 5V

● Electrical characteristic curves

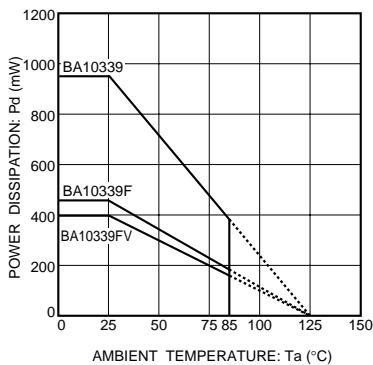

Fig. 1 Power dissipation vs. ambient temperature

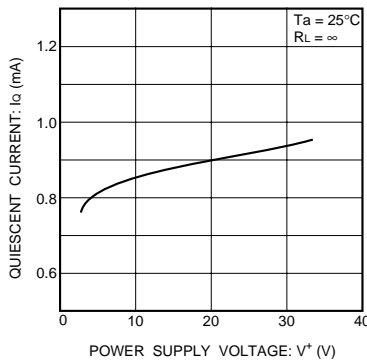

Fig. 2 Quiescent current vs. power supply voltage

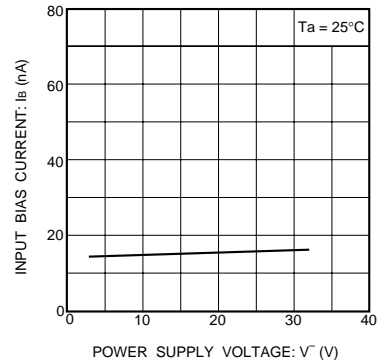

Fig. 3 Input bias current vs. power supply voltage

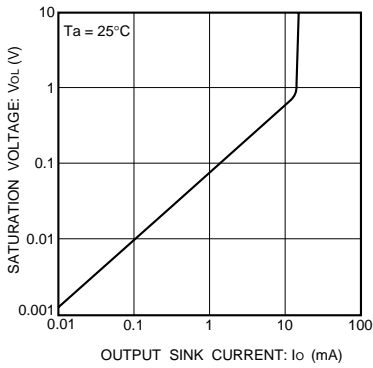

Fig. 4 Output saturation voltage vs. output current

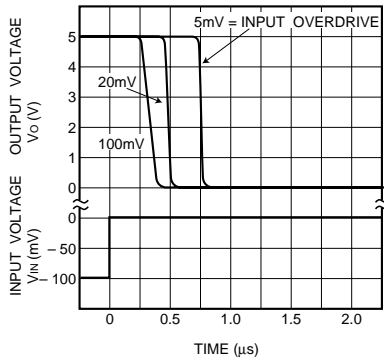

Fig. 5 Propagation characteristics (I)

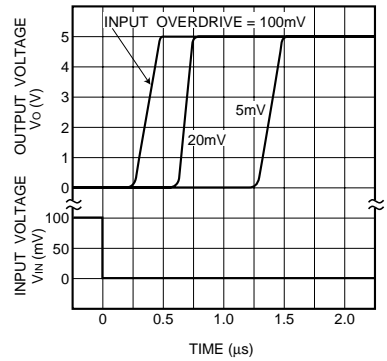

Fig. 6 Propagation characteristics (II)

●Operation notes

(1) Handling unused circuits

If there are any circuits which are not being used, we recommend making connections as shown in Figure 7, with the input going to the potential within the in-phase input voltage range (V_{ICM}), and the output being open.

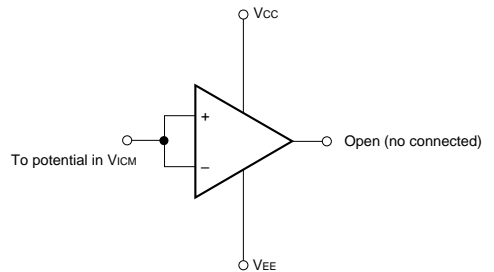

Fig. 7 Unused circuit connections

●External dimensions (Units: mm)

